



catalogo  
*catalogue*

20  
15



professional



**MUNDIAL**  
Utensileria Alfredo Casartelli **ITALY**

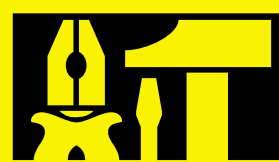

**utensili professionali**

[www.mundial-casartelli.it](http://www.mundial-casartelli.it)

**professional tools**





10



16



33



48



54



74



88



94



100



127



132



155



175



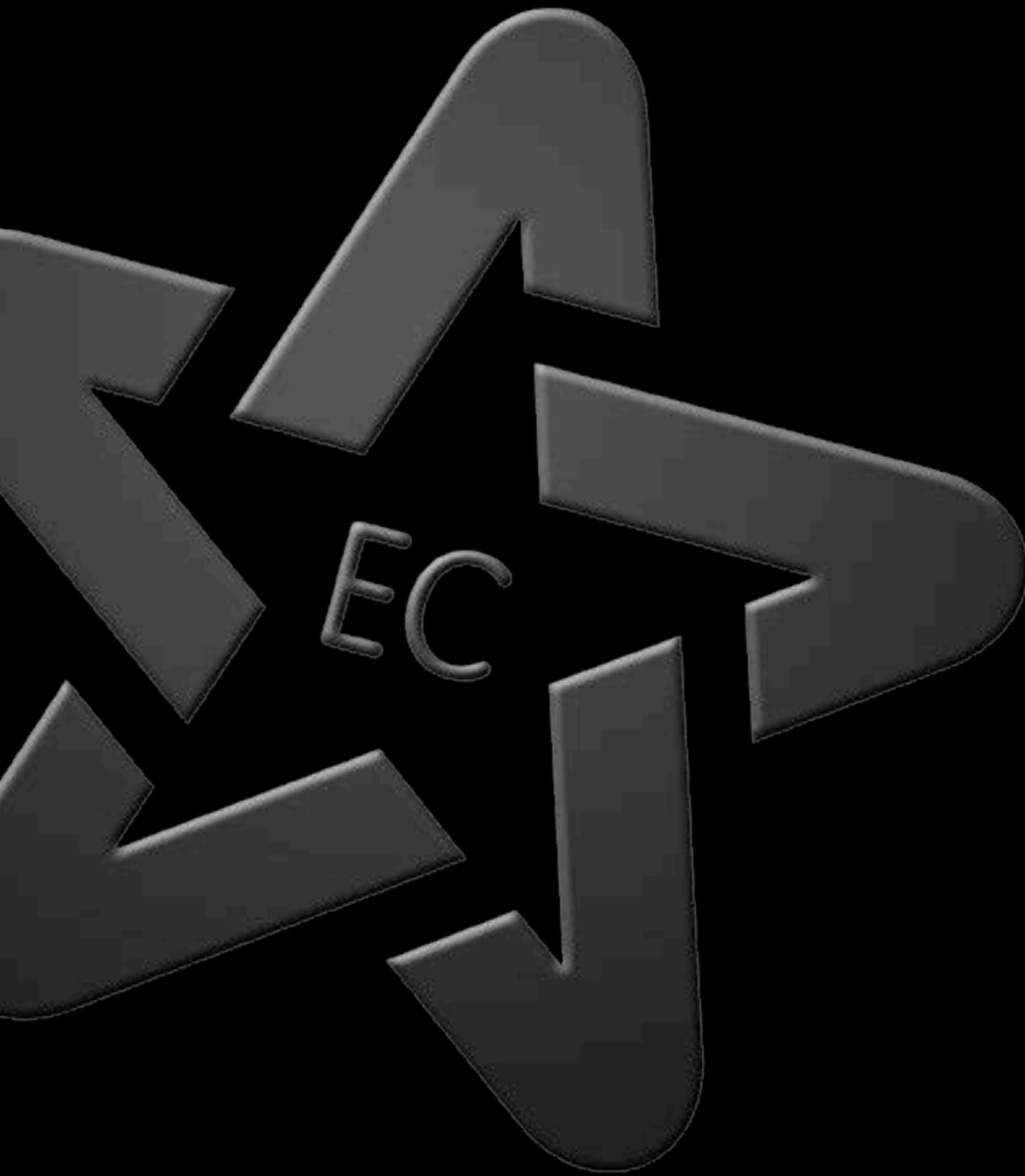

dal  
since **1929**





**dal 1929 produzione utensili professionali**  
 since 1929 professional tools manufacturer



**qualità garantita**  
 quality guarantee

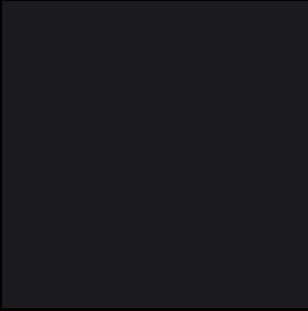

**gamma completa**  
 complete range

Mundial Alfredo Casartelli srl **produce** utensili a mano professionali.

**Qualità**, design, innovazione e competitività sono caratteristiche che **dal 1929** accompagnano i prodotti Mundial sul mercato nazionale ed internazionale. Mundial offre una gamma completa di **utensili professionali**: giraviti, pinze, chiavi, chiavi a bussola, scalpelli, martelli, carrelli portautensili... tutti prodotti con materiali selezionati e con le tecnologie più innovative frutto dell'esperienza acquisita in oltre 70 anni d'attività.

La gamma Mundial si rivolge ai professionisti dei settori **utensileria, industria, autoriparazione, elettrico, idraulica, edilizia**... garantendo alti standard qualitativi.

Il continuo impegno aziendale è rivolto al miglioramento dei materiali alla realizzazione di nuovi prodotti e allo sviluppo di nuove impugnature **ergonomiche**. Mundial supporta la distribuzione con **espositori** specifici per categoria di utensili e propone l'intera gamma anche in confezione **self-service** appendibile per la vendita a libero servizio.

Mundial attualmente si propone sul mercato come un'azienda di grande **tradizione** ma moderna ed in continuo rinnovamento per dare sempre un **servizio** completo e costante alla clientela.

Mundial Alfredo Casartelli s.r.l. is a **manufacturer** of professional hand tools.

**Since 1929**, **quality**, design, innovation and competitiveness are Mundial's leading features, both on national and international markets.

The firm offers a full-spectrum range of **professional tools**: screwdrivers, pliers, wrenches, sockets, chisels, trolleys... all made of selected materials and employing the most innovative technologies developed over a more than 70 year-long activity. Mundial range addresses professional workers in the fields of **hardware tools, industry, automotive, electric, hydraulics, building**, always providing high quality standards.

Mundial's ongoing engagement is focused on material improvement and new products manufacturing, not to mention developing new **ergonomic** handles.

Category-based **displays** underlie Mundial's distribution; moreover, hanging **self-service** packaging are available with the whole range of products, focusing on self-service sellings. Nowadays, Mundial's image on the market represents its great **tradition** along with modernity and an ongoing renewal to offer customers a complete and steadfast **service**.



**servizio al cliente**  
 customer care



# nuovi prodotti new products

**750**



**773**



**1383**



**1557**



**1803**





# nuovi prodotti new products

**441**



distanza ridotta - riduce lo sforzo del 45%  
reduced distance - less effort of 45%

**1040**



- per operare in profondità  
- for operating in recess

**376**



**478Z**



**552**



**593Z**



chiavi combinate a cricchetto  
snodate - reversibili - semplici

combination wrench  
flex - reversible - simple



180°



72 denti - teeth

5° ripresa



mm 8 ÷ 24

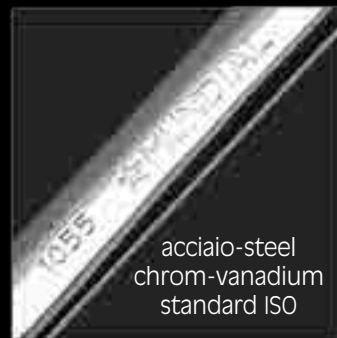

acciaio-steel  
chrom-vanadium  
standard ISO



S - L

D - R



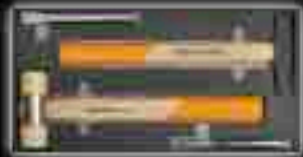

professional

professional

**professional**



## carrelli per utensili con moduli morbidi in spugna bicolore

- resistente a prodotti chimici
- bicolore per immediata identificazione utensili mancanti
- sagomatura precisa per ogni utensile
- moduli intercambiabili con altri tipi

## trolleys for tools with soft sponge double colour modules

- chemical product resistant
- double-colour for missing tools identification
- precision profile for each tools
- interchangeable modules



utensili isolati  
certificati VDE 1000 Volt 60900  
impugnatura bicomponente  
ergonomica

*insulated tools  
VDE 1000 Volt 60900 certificated  
ergonomic bicomponent handle*

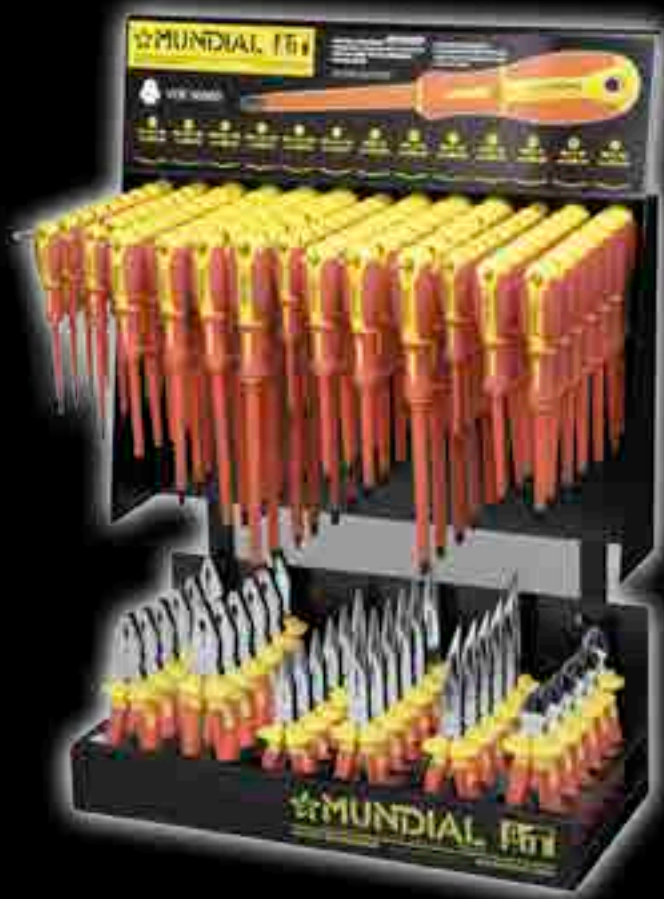



## COMMOGRIP

giravite professionale  
impugnatura bicomponente  
ergonomica

lama in acciaio  
chrom-molibdenum HRC60

*professional screwdriver  
ergonomic bicomponent handle  
chrom-molybdenum steel HRC60 blade*



foro per appendere  
*hanging hole*



profilo triangolare  
per trasmissione sforzo  
*triangle section for  
force transmission*



sezione cilindrica  
per rotazione rapida  
*cylindric section  
for fast rotation*



codice a barre e simbolo  
*bar code and symbol*



acciaio - *steel*  
chrom-molybdenum  
durezza - *hardness* HRC60

professional



# utensileria tools



## 0010 Espositore 605 utensili - **UTENSILERIA** Display stand 605 tools - **TOOLS**

Contenuto - content:			
0346.070	Nr. 6	0506.017	Nr. 6
0347.090	Nr. 6	0510.018	Nr. 6
0351.090	Nr. 6	0511.017	Nr. 6
0366.090	Nr. 6	1050.010	Pz. 158
0439.915	Pz. 36	1570.010	Pz. 180
0490.024	Nr. 6	0380.030	Nr. 6
0420.022	Nr. 6	0380.050	Nr. 6
0505.018	Nr. 6	0068.010	Pz. 159

Dimensione-dimension: mm 1000 x 450 x h. 2050

0010.010 605 PZ.

punto vendita-sales point  
**mundial merchandising**  
 esposizione organizzata  
 organized exhibition

- espositori personalizzati e funzionali per categorie di utensili  
 special display for each tools range
- riduzione dello spazio espositivo  
 reduced exhibition area



# industria industry

**0012** Espositore 248 utensili - **INDUSTRIA**  
 Display stand 248 tools - **INDUSTRY**

Contenuto - content:			
1150.190	Nr. 2	1064.010	Pz. 24
1150.170	Nr. 2	0375.035	Nr. 2
1150.130	Nr. 2	0375.040	Nr. 2
1150.100	Nr. 2	0376.035	Nr. 2
1150.080	Nr. 2	0376.040	Nr. 2
1070.020	Nr. 2	0380.030	Nr. 2
1070.025	Nr. 2	0380.050	Nr. 2
1070.030	Nr. 2	0474.025	Nr. 2
1100.010	Pz. 78	0478.010	Nr. 2
1328.170	Nr. 2	0593.910	Nr. 2
1328.130	Nr. 2	0623.010	Pz. 63
1328.100	Nr. 2	1555.010	Nr. 1
1328.080	Nr. 2	1557.010	Nr. 1
1058.010	Pz. 24	1702.100	Nr. 1
0344.330	Nr. 2		
0344.340	Nr. 2		
0344.350	Nr. 2		
0344.360	Nr. 2		
1075.036	Nr. 1		
1075.041	Nr. 1		
1075.050	Nr. 1		
1076.036	Nr. 1		
1076.041	Nr. 1		
1076.050	Nr. 1		

Dimensione-dimension: mm 1000 x 450 x h. 2050

**0012.010** 248 PZ. 

# idraulica hydraulics

**0014** Espositore 143 utensili - **IDRAULICA**  
 Display stand 143 tools - **HYDRAULICS**

Contenuto - content:			
0502.054	Nr. 2	0492.024	Nr. 6
0502.040	Nr. 2	0770.022	Nr. 2
0502.032	Nr. 2	0772.032	Nr. 2
0502.025	Nr. 2	0773.010	Nr. 2
0502.740	Nr. 2	0774.032	Nr. 2
0502.732	Nr. 2	0777.127	Nr. 2
0503.030	Nr. 2	0782.002	Nr. 1
0503.041	Nr. 2	0790.042	Nr. 2
0503.052	Nr. 2	0792.042	Nr. 2
0503.062	Nr. 2	0794.063	Nr. 2
0504.025	Nr. 2	0796.100	Nr. 2
0504.030	Nr. 2	0798.240	Nr. 2
0504.725	Nr. 2	0500.022	Nr. 2
0504.735	Nr. 2	0501.010	Nr. 2
0504.950	Nr. 2	0504.118	Nr. 2
0490.030	Nr. 6	0504.124	Nr. 2
0490.024	Nr. 6	0593.910	Nr. 2
0490.018	Nr. 6	1051.247	Nr. 2
0491.024	Nr. 6	1051.224	Nr. 2
1070.030	Nr. 4		
1070.025	Nr. 4		
1070.020	Nr. 4		
0560.025	Nr. 4		
0561.010	Nr. 2		
0562.010	Nr. 2		
0563.010	Nr. 2		
0564.010	Nr. 2		
0565.010	Nr. 2		
0566.010	Nr. 2		
0567.010	Nr. 2		
0568.010	Nr. 2		
0351.090	Nr. 6		
0840.010	Nr. 2		
0841.010	Nr. 2		
0807.010	Nr. 1		
0815.010	Nr. 1		
1548.010	Nr. 2		
0064.010	Nr. 2		

Dimensione-dimension: mm 1000 x 450 x h. 2050

**0014.010** 143 PZ. 





# edilizia building

## 0015 Espositore 280 utensili - EDILIZIA Display stand 280 tools - BUILDING

Contenuto - content:			
0062.010	Nr. 2	0404.020	Nr. 6
0066.010	Pz. 102	0439.310	Pz. 36
0094.010	Nr. 2	0503.041	Nr. 2
0347.090	Nr. 6	0560.025	Nr. 2
0382.925	Nr. 6	0563.010	Nr. 6
0382.930	Nr. 6	0635.010	Pz. 48
0382.940	Nr. 6	0683.010	Nr. 12
0383.908	Nr. 6	0792.042	Nr. 2
0383.910	Nr. 6	1023.080	Nr. 2
0383.912	Nr. 6	1033.080	Nr. 2
0402.045	Nr. 2	1052.212	Nr. 6
0402.060	Nr. 2	1053.212	Nr. 2
0402.075	Nr. 2		

Dimensione-dimension: mm 1000 x 450 x h. 2050

0015.010 280 PZ. XXXXXXXXXX

# autoattrezzature automotive

## 0016 Esp. 394 utens. - AUTOATTEZZATURE Disp. stand 394 tools - AUTOMOTIVE

Contenuto - content:					
0512.110	Pz. 36	1158.160	Nr. 1	0478.910	Nr. 2
0066.010	Pz. 102	1158.200	Nr. 1	1066.010	Pz. 24
1570.010	Pz. 180	1340.010	Nr. 1	1702.100	Nr. 1
1150.080	Nr. 1	1341.010	Nr. 1	1702.200	Nr. 1
1150.100	Nr. 1	1652.100	Nr. 1	1360.011	Nr. 1
1150.130	Nr. 1	1652.130	Nr. 1	1360.015	Nr. 2
1150.170	Nr. 1	1652.170	Nr. 1	1362.015	Nr. 2
1150.190	Nr. 1	1652.190	Nr. 1	1383.010	Nr. 2
1150.220	Nr. 1	1652.220	Nr. 1	1385.010	Nr. 2
1334.270	Nr. 1	1652.240	Nr. 1	1386.010	Nr. 2
1334.272	Nr. 1	1652.270	Nr. 1	1388.038	Nr. 2
1336.179	Nr. 1	1653.012	Nr. 1	1388.055	Nr. 2
1152.030	Nr. 1	1048.068	Nr. 2		
1152.040	Nr. 1	1048.102	Nr. 2		
1152.050	Nr. 1	1048.148	Nr. 2		
1152.060	Nr. 1	1048.204	Nr. 2		

Dimensione-dimension: mm 1000 x 450 x h. 2050

0016.010 394 PZ. XXXXXXXXXX





# elettrico electric

**0017** Espositore 341 utensili - **ELETRICO**  
 Display stand 341 tools - **ELECTRIC**

Contenuto - content:

0066.010	Pz. 102	0525.010	Nr. 6	0750.010	Nr. 2
0094.010	Nr. 3	0526.010	Nr. 6	0751.010	Nr. 2
0095.010	Nr. 3	0527.010	Nr. 6	0752.010	Nr. 2
0096.010	Pz. 101	0680.010	Nr. 12	0756.010	Nr. 2
0377.030	Nr. 6	0683.010	Nr. 12		
0383.908	Nr. 6	0686.110	Nr. 12		
0520.010	Nr. 6	0728.010	Pz. 36		
0522.010	Nr. 6	0700.010	Nr. 2		
0524.010	Nr. 6	0741.020	Nr. 2		

Dimensione-dimension: mm 1000 x 450 x h. 2050

**0017.010** 341 PZ. XXXXXXXXXX

**0020** Espositore da parete - **VUOTO**  
 Wall display stand - **EMPTY**

Per espositori / For display stand: 0010 - 0012 - 0014 - 0015 - 0016 - 0017  
 Dimensione-dimension: mm 1000 x 450 x h. 2050

**0020.210** vuoto/empty XXXXXXXXXX

# giraviti screwdrivers

**0070** Espositore 477 giraviti - **metallo**  
 Display stand 477 screwdrivers - **metal**

Dimensione-dimension: mm 500 x 777 x h. 2000

**0070.010** 477 PZ. XXXXXXXXXX



# libero servizio self-service

**0024.010** Esp. 634 utensili - **SELF-SERVICE**  
 Disp. stand 634 tools - **SELF-SERVICE**

Contenuto - content:

0050.307-9	Nr. 12	0344.040-9	Nr. 6	1030.060-9	Nr. 12	1500.080-9	Nr. 6
0050.410-9	Nr. 12	0344.050-9	Nr. 6	1030.070-9	Nr. 12	1500.090-9	Nr. 6
0050.512-9	Nr. 12	0377.020-9	Nr. 6	1030.080-9	Nr. 12	1500.100-9	Nr. 6
0050.612-9	Nr. 12	0377.030-9	Nr. 6	1030.090-9	Nr. 12	1500.110-9	Nr. 6
0050.615-9	Nr. 6	0412.916-9	Nr. 6	1030.100-9	Nr. 12	1500.120-9	Nr. 6
0050.815-9	Nr. 6	0417.022-9	Nr. 6	1030.110-9	Nr. 12	1500.130-9	Nr. 6
0052.010-9	Nr. 12	0440.918-9	Nr. 6	1030.120-9	Nr. 12	1500.140-9	Nr. 6
0052.108-9	Nr. 12	0440.920-9	Nr. 6	1030.130-9	Nr. 12	1500.150-9	Nr. 6
0052.210-9	Nr. 12	0463.916-9	Nr. 6	1030.140-9	Nr. 12	1500.160-9	Nr. 6
0052.315-9	Nr. 6	0466.916-9	Nr. 6	1030.150-9	Nr. 12	1500.170-9	Nr. 6
0053.108-9	Nr. 12	0474.025-9	Nr. 2	1030.160-9	Nr. 12	1500.180-9	Nr. 6
0053.210-9	Nr. 12	0490.024-9	Nr. 6	1030.170-9	Nr. 12	1500.190-9	Nr. 6
0075.100-9	Nr. 6	0680.010	Nr. 12	1030.180-9	Nr. 6	1500.210-9	Nr. 6
0075.150-9	Nr. 6	0347.090	Nr. 6	1030.190-9	Nr. 6	1500.220-9	Nr. 6
0075.200-9	Nr. 6	0366.090	Nr. 6	1030.200-9	Nr. 6	1505.010-9	Nr. 2
0075.250-9	Nr. 6	1020.067-9	Nr. 12	1030.210-9	Nr. 6	1508.125-9	Nr. 4
0090.310-9	Nr. 6	1020.089-9	Nr. 12	1030.220-9	Nr. 6	1510.010-9	Nr. 6
0090.410-9	Nr. 6	1020.101-9	Nr. 12	1033.080	Nr. 2	1512.010-9	Nr. 6
0092.110-9	Nr. 6	1020.123-9	Nr. 12	1067.080-9	Nr. 6	0062.010	Nr. 2
0344.025-9	Nr. 6	1020.145-9	Nr. 12	1067.100-9	Nr. 6	1548.010	Nr. 2
0344.030-9	Nr. 6	1023.080	Nr. 2	1067.130-9	Nr. 6		

Dimensione-dimension: mm 1000 x 450 x h. 2050

**0024.010** 634 PZ.



- confezioni appendibili personalizzate per categorie di utensili  
hanged special packaging for each tools range
- ingombro ridotto della confezione appendibile  
smaller hanged packaging
- valorizzazione dell'utensile  
make the most of tools
- per prodotto confezionato self-service aggiungere al codice "-9"  
(es: 1030.130 - 9). Vedi pagina 175.  
for products in self-service packing add to code "-9" (ex. 1030.130-9).  
See page 175.







# libero servizio self-service

**0025.030** Esp. 1116 utensili - **SELF-SERVICE**  
 Disp. stand 1116 tools - **SELF-SERVICE**

Contenuto - content:

0344.320-9 Nr. 6	1020.202-9 Nr. 6	1055.100-9 Nr. 6	1500.140-9 Nr. 6	0051.415-9 Nr. 12	0090.615-9 Nr. 6	0490.018-9 Nr. 6
0344.325-9 Nr. 6	1023.080 Nr. 2	1055.130-9 Nr. 6	1500.150-9 Nr. 6	0051.515-9 Nr. 12	0092.007-9 Nr. 6	0490.024-9 Nr. 6
0344.330-9 Nr. 6	1030.060-9 Nr. 12	1055.170-9 Nr. 6	1500.160-9 Nr. 6	0052.010-9 Nr. 12	0092.110-9 Nr. 6	0490.030-9 Nr. 6
0344.340-9 Nr. 6	1030.070-9 Nr. 12	1055.190-9 Nr. 6	1500.170-9 Nr. 6	0052.108-9 Nr. 12	0092.210-9 Nr. 6	0505.018-9 Nr. 6
0344.350-9 Nr. 6	1030.080-9 Nr. 12	1092.067-9 Nr. 6	1500.180-9 Nr. 6	0052.112-9 Nr. 12	0094.010 Nr. 1	0506.017-9 Nr. 6
0344.360-9 Nr. 6	1030.090-9 Nr. 12	1092.089-9 Nr. 6	1500.190-9 Nr. 6	0052.210-9 Nr. 12	0344.020-9 Nr. 6	0510.018-9 Nr. 6
0347.090 Nr. 6	1030.100-9 Nr. 12	1092.101-9 Nr. 6	1500.210-9 Nr. 6	0052.215-9 Nr. 6	0344.025-9 Nr. 6	0511.017-9 Nr. 6
0351.090 Nr. 6	1030.110-9 Nr. 12	1092.123-9 Nr. 6	1500.220-9 Nr. 6	0052.315-9 Nr. 6	0344.030-9 Nr. 6	0560.025-9 Nr. 2
0366.090 Nr. 6	1030.120-9 Nr. 12	1092.145-9 Nr. 6	1500.240-9 Nr. 6	0053.108-9 Nr. 12	0344.040-9 Nr. 6	0580.060-9 Nr. 6
0502.032-9 Nr. 2	1030.130-9 Nr. 12	1092.167-9 Nr. 6	1500.270-9 Nr. 6	0053.210-9 Nr. 12	0344.050-9 Nr. 6	0580.100-9 Nr. 6
0503.030-9 Nr. 2	1030.140-9 Nr. 12	1098.080-9 Nr. 6	1500.300-9 Nr. 6	0055.603-9 Nr. 12	0370.035 Nr. 4	0580.140-9 Nr. 6
0503.041-9 Nr. 2	1030.150-9 Nr. 12	1098.100-9 Nr. 6	1500.320-9 Nr. 6	0056.103-9 Nr. 12	0372.030 Nr. 4	0580.180-9 Nr. 6
0504.030-9 Nr. 2	1030.160-9 Nr. 12	1098.130-9 Nr. 6	1505.010-9 Nr. 2	0058.430-9 Nr. 6	0377.020 Nr. 6	0680.010 Nr. 12
0504.045-9 Nr. 1	1030.170-9 Nr. 12	1098.170-9 Nr. 6	1508.125-9 Nr. 4	0059.130-9 Nr. 6	0377.030 Nr. 6	0683.010 Nr. 6
0770.022-9 Nr. 2	1030.180-9 Nr. 6	1098.190-9 Nr. 6	1508.250-9 Nr. 4	0062.010 Nr. 2	0404.020-9 Nr. 6	1070.015-9 Nr. 2
0774.032-9 Nr. 2	1030.190-9 Nr. 6	1150.080-9 Nr. 6	1510.010-9 Nr. 6	0064.010 Nr. 2	0412.916-9 Nr. 6	1070.020-9 Nr. 2
0790.042-9 Nr. 2	1030.200-9 Nr. 6	1150.100-9 Nr. 6	1512.010-9 Nr. 6	0075.060-9 Nr. 6	0417.022-9 Nr. 6	1070.025-9 Nr. 2
0792.042-9 Nr. 2	1030.210-9 Nr. 6	1150.130-9 Nr. 2	1527.160-9 Nr. 6	0075.100-9 Nr. 6	0417.025-9 Nr. 6	1442.010 Nr. 1
1020.067-9 Nr. 12	1030.220-9 Nr. 6	1150.170-9 Nr. 6	0050.307-9 Nr. 12	0075.150-9 Nr. 6	0425.020-9 Nr. 6	1548.010 Nr. 1
1020.089-9 Nr. 12	1030.240-9 Nr. 6	1500.080-9 Nr. 6	0050.410-9 Nr. 12	0075.200-9 Nr. 6	0440.918-9 Nr. 6	
1020.101-9 Nr. 12	1030.270-9 Nr. 6	1500.090-9 Nr. 6	0050.512-9 Nr. 12	0075.250-9 Nr. 6	0440.920-9 Nr. 6	
1020.123-9 Nr. 12	1030.300-9 Nr. 6	1500.100-9 Nr. 6	0050.612-9 Nr. 12	0075.300-9 Nr. 6	0463.916-9 Nr. 6	
1020.145-9 Nr. 12	1033.080 Nr. 2	1500.110-9 Nr. 6	0050.615-9 Nr. 6	0090.310-9 Nr. 6	0466.916-9 Nr. 6	
1020.167-9 Nr. 12	1033.120 Nr. 2	1500.120-9 Nr. 6	0050.815-9 Nr. 6	0090.410-9 Nr. 6	0467.916-9 Nr. 6	
1020.189-9 Nr. 6	1055.080-9 Nr. 6	1500.130-9 Nr. 6	0051.310-9 Nr. 12	0090.512-9 Nr. 6	0474.025-9 Nr. 2	

Dimensione-dimension: mm 2000 x 450 x h. 2050

**0025.030**

1116 PZ. XXXXXXXXXX



**50**

**GIRAVITE PER VITI INTAGLIO-MECCANICI - acciaio chrom-vanadium-molibdeno finitura cromata punta nera**  
**SCREWDRIVER FOR SLOTTED HEAD SCREWS-MECHANIC - chrom-vanadium-molybdenum steel chrome plated black finish tip**

acciaio chrom-molybdenum durezza HRC 60  
 chrom-molybdenum steel hardness HRC 60

sezione cilindrica per rotazione rapida  
 cylindrical section for fast rotation

profilo triangolare per trasmissione sforzo  
 triangle section for force transmission



DIN 5265 ISO 2380 HRC 60 Chrom-Vanadium-Molibdeno

Icona	ISO 2380	ISO 2380	ISO 2380	ISO 2380	ISO 2380	ISO 2380	ISO 2380	ISO 2380	ISO 2380	ISO 2380	ISO 2380
0050.307	3,0 x 0,5 x 75	87,5 x 25,4	30	12	8011578950002						
0050.310	3,0 x 0,5 x 100	87,5 x 25,4	32	12	8011578950033						
0050.410	4,0 x 0,8 x 100	109 x 31,7	64	12	8011578950095						
0050.412	4,0 x 0,8 x 125	109 x 31,7	64	12	8011578950125						
0050.510	5,5 x 1,0 x 100	109 x 31,7	72	12	8011578950156						
0050.512	5,5 x 1,0 x 125	109 x 31,7	74	12	8011578950187						
0050.515	5,5 x 1,0 x 150	109 x 31,7	78	12	8011578950217						
0050.610	6,5 x 1,2 x 100	117 x 34,0	86	12	8011578950248						
0050.612	6,5 x 1,2 x 125	117 x 34,0	94	12	8011578950279						
0050.615	6,5 x 1,2 x 150	117 x 34,0	98	6	8011578950309						
0050.815	8,0 x 1,2 x 150	127 x 36,9	125	6	8011578950330						
0050.820	8,0 x 1,2 x 200	127 x 36,9	164	6	8011578950361						
0050.920	10,0 x 1,6 x 200	127 x 36,9	200	6	8011578950378						



**51**

**GIRAVITE PER VITI INTAGLIO-LAME PARALLELE - acciaio chrom-vanadium-molibdeno finitura cromata punta nera**  
**SCREWDRIVER FOR SLOTTED HEAD SCREWS-CABINET - chrom-vanadium-molybdenum steel chrome plated black finish tip**

DIN 5265 ISO 2380 HRC 60

Icona	ISO 2380	ISO 2380	ISO 2380	ISO 2380	ISO 2380	ISO 2380
0051.256	2,5 x 0,4 x 60	87,5 x 25,4	28	12	8011578950392	
0051.310	3,0 x 0,5 x 100	87,5 x 25,4	32	12	8011578950422	
0051.412	4,0 x 0,8 x 125	109 x 31,7	64	12	8011578950453	
0051.415	4,0 x 0,8 x 150	109 x 31,7	62	12	8011578950484	
0051.515	5,0 x 1,0 x 150	109 x 31,7	72	12	8011578950545	



**52**

**GIRAVITE PER VITI CROCE PHILLIPS - acciaio chrom-vanadium-molibdeno finitura cromata punta nera**  
**SCREWDRIVER FOR PHILLIPS CROSS HEAD SCREWS - chrom-vanadium-molybdenum steel chrome plated black finish tip**

DIN 5262 ISO 8764 HRC 60

Icona	ISO 8764	ISO 8764	ISO 8764	ISO 8764	ISO 8764	ISO 8764
0052.006	PH 0 x 60 x 3,0	87,5 x 25,4	30	12	8011578950606	
0052.010	PH 0 x 100 x 3,0	87,5 x 25,4	34	12	8011578950637	
0052.108	PH 1 x 80 x 4,5	109 x 31,7	68	12	8011578950668	
0052.112	PH 1 x 125 x 4,5	109 x 31,7	76	12	8011578950699	
0052.210	PH 2 x 100 x 6,0	117 x 34,0	92	12	8011578950729	
0052.215	PH 2 x 150 x 6,0	117 x 34,0	98	6	8011578950750	
0052.315	PH 3 x 150 x 8,0	127 x 36,9	146	6	8011578950781	



**53**

**GIRAVITE PER VITI CROCE POZIDRIV - acciaio chrom-vanadium-molibdeno finitura cromata punta nera**  
**SCREWDRIVER FOR POZIDRIV CROSS HEAD SCREWS - chrom-vanadium-molybdenum steel chrome plated black finish tip**

DIN 5262 ISO 8764 HRC 60

Icona	ISO 8764	ISO 8764	ISO 8764	ISO 8764	ISO 8764	ISO 8764
0053.006	PZ 0 x 60 x 3,0	87,5 x 25,4	30	12	8011578950811	
0053.108	PZ 1 x 80 x 4,5	109 x 31,7	66	12	8011578950842	
0053.112	PZ 1 x 125 x 4,5	109 x 31,7	72	12	8011578950873	
0053.210	PZ 2 x 100 x 6,0	117 x 34,0	88	12	8011578950903	
0053.215	PZ 2 x 150 x 6,0	117 x 34,0	102	6	8011578950934	
0053.315	PZ 3 x 150 x 8,0	127 x 36,9	148	6	8011578950965	



**55**
**GIRAVITE PER VITI INTAGLIO-MECCANICI - acciaio chrom-vanadium-molibdeno finitura cromata punta nera**  
**SCREWDRIVER FOR SLOTTED HEAD SCREWS-MECHANIC - chrom-vanadium-molybdenum steel chrome plated black finish tip**

DIN 5265 ISO 2380

<b>0055.403</b>	<b>5,0 x 0,8 x 38</b>	55 x 32	34	<b>12</b>	8011578950996	
<b>0055.603</b>	<b>6,5 x 1,0 x 38</b>	55 x 32	36	<b>12</b>	8011578951023	

**56**
**GIRAVITE PER VITI CROCE PHILLIPS - acciaio chrom-vanadium-molibdeno finitura cromata punta nera**  
**SCREWDRIVER FOR PHILLIPS CROSS HEAD SCREWS - chrom-vanadium-molybdenum steel chrome plated black finish tip**

DIN 5262 ISO 8764

<b>0056.103</b>	<b>PH 1 x 38 x 4,5</b>	55 x 32	34	<b>12</b>	8011578951054	
<b>0056.203</b>	<b>PH 2 x 38 x 6,0</b>	55 x 32	36	<b>12</b>	8011578951085	

**57**
**GIRAVITE PER VITI CROCE POZIDRIV - acciaio chrom-vanadium-molibdeno finitura cromata punta nera**  
**SCREWDRIVER FOR POZIDRIV CROSS HEAD SCREWS - chrom-vanadium-molybdenum steel chrome plated black finish tip**

DIN 5262 ISO 8764

<b>0057.103</b>	<b>PZ 1 x 38 x 4,5</b>	55 x 32	34	<b>12</b>	8011578951115	
<b>0057.203</b>	<b>PZ 2 x 38 x 6,0</b>	55 x 32	36	<b>12</b>	8011578951146	

**58**
**GIRAVITE PER VITI INTAGLIO-LAME PARALLELE - acciaio chrom-vanadium-molibdeno finitura cromata punta nera**  
**SCREWDRIVER FOR SLOTTED HEAD SCREWS-CABINET - chrom-vanadium-molybdenum steel chrome plated black finish tip**

mm 300 - 400

<b>0058.330</b>	<b>3,0 x 0,5 x 300</b>	87,5 x 25,4	42	<b>6</b>	8011578951177	
<b>0058.430</b>	<b>4,0 x 0,8 x 300</b>	109 x 31,7	80	<b>6</b>	8011578951207	
<b>0058.440</b>	<b>4,0 x 0,8 x 400</b>	109 x 31,7	85	<b>6</b>	8011578963286	<b>new</b>
<b>0058.530</b>	<b>5,0 x 0,8 x 300</b>	109 x 31,7	96	<b>6</b>	8011578951238	
<b>0058.630</b>	<b>6,0 x 1,0 x 300</b>	117 x 34,0	130	<b>6</b>	8011578951269	
<b>0058.640</b>	<b>6,0 x 1,0 x 400</b>	117 x 34,0	135	<b>6</b>	8011578963309	<b>new</b>

**59**
**GIRAVITE PER VITI CROCE PHILLIPS - acciaio chrom-vanadium-molibdeno finitura cromata punta nera**  
**SCREWDRIVER FOR PHILLIPS CROSS HEAD SCREWS - chrom-vanadium-molybdenum steel chrome plated black finish tip**

<b>0059.030</b>	<b>PH 0 x 300 x 3,0</b>	87,5 x 25,4	42	<b>6</b>	8011578951290	
<b>0059.130</b>	<b>PH 1 x 300 x 4,5</b>	109 x 31,7	98	<b>6</b>	8011578951320	
<b>0059.140</b>	<b>PH 1 x 400 x 4,5</b>	109 x 31,7	102	<b>6</b>	8011578963323	<b>new</b>
<b>0059.230</b>	<b>PH 2 x 300 x 6,0</b>	117 x 34,0	130	<b>6</b>	8011578951351	
<b>0059.240</b>	<b>PH 2 x 400 x 6,0</b>	117 x 34,0	134	<b>6</b>	8011578963347	<b>new</b>



**62**

**SERIE 5 GIRAVITI intaglio - croce PH - cartone**  
**SET 5 SCREWDRIVERS slotted - cross PH - box**



Contenuto-content:

0050.307 3,0 x 0,5 x 75 0052.108 PH 1 x 80 - 4,5  
 0050.410 4,0 x 0,8 x 100 0052.210 PH 2 x 100 - 6  
 0050.612 6,5 x 1,2 x 125



**0062.010** 310 x 180 x 37

490

8011578956356



**63**

**SERIE 5 GIRAVITI intaglio - croce PZ - cartone**  
**SET 5 SCREWDRIVERS slotted - cross PZ - box**



Contenuto-content:

0050.307 3,0 x 0,5 x 75 0053.108 PZ 1 x 80 - 4,5  
 0050.410 4,0 x 0,8 x 100 0053.210 PZ 2 x 100 - 6  
 0050.612 6,5 x 1,2 x 125



**0063.010** 310 x 180 x 37

484

8011578956387



**64**

**SERIE 7 GIRAVITI intaglio - croce PH - cartone**  
**SET 7 SCREWDRIVERS slotted - cross PH - box**



Contenuto-content:

0050.307 3,0 x 0,5 x 75 0052.006 PH 0 x 60 - 3  
 0050.410 4,0 x 0,8 x 100 0052.108 PH 1 x 80 - 4,5  
 0050.510 5,5 x 1,0 x 100 0052.210 PH 2 x 100 - 6  
 0050.612 6,5 x 1,2 x 125



**0064.010** 330 x 220 x 40

636

8011578956417



**66**
**ESPOSITORE 102 GIRAVITI - metallo**  
 DISPLAY STAND 102 SCREWDRIVERS - metal

Contenuto-content:

0050.307	3,0 x 0,5 x 75	Nr. 9
0050.410	4,0 x 0,8 x 100	Nr. 8
0050.512	5,5 x 1,0 x 125	Nr. 8
0050.612	6,5 x 1,2 x 125	Nr. 7
0050.815	8,0 x 1,2 x 150	Nr. 6
0051.310	3,0 x 0,5 x 100	Nr. 9
0051.415	4,0 x 0,8 x 150	Nr. 8
0051.515	5,0 x 1,0 x 150	Nr. 8
0052.010	PH 0 x 100 - 3	Nr. 9
0052.108	PH 1 x 80 - 4,5	Nr. 8
0052.210	PH 2 x 100 - 6	Nr. 7
0053.108	PZ 1 x 80 - 5	Nr. 8
0053.210	PZ 2 x 100 - 6	Nr. 7



**0066.010** 500 x 280 x 450  
**0066.210** vuoto - empty



14000  
6800



8 011578 000004  
8011578956448  
8011578949143

**68**
**ESPOSITORE 159 GIRAVITI - metallo**  
 DISPLAY STAND 159 SCREWDRIVERS - metal

Contenuto-content:

0050.307	3,0 x 0,5 x 75	Nr. 9
0050.410	4,0 x 0,8 x 100	Nr. 8
0050.512	5,5 x 1,0 x 125	Nr. 8
0050.612	6,5 x 1,2 x 125	Nr. 7
0050.615	6,5 x 1,2 x 150	Nr. 7
0050.815	8,0 x 1,2 x 150	Nr. 6
0051.310	3,0 x 0,5 x 100	Nr. 9
0051.415	4,0 x 0,8 x 150	Nr. 8
0051.515	5,0 x 1,0 x 150	Nr. 8
0052.010	PH 0 x 100 - 3	Nr. 9
0052.108	PH 1 x 80 - 4,5	Nr. 8
0052.112	PH 1 x 125 - 4,5	Nr. 8
0052.210	PH 2 x 100 - 6	Nr. 7
0052.215	PH 2 x 150 - 6	Nr. 7
0052.315	PH 3 x 150 - 8	Nr. 6
0053.006	PZ 0 x 60 - 3	Nr. 9
0053.108	PZ 1 x 80 - 5	Nr. 8
0053.210	PZ 2 x 100 - 6	Nr. 7
0053.315	PZ 3 x 150 - 8	Nr. 6
0055.603	6,0 x 1,0 x 30 - 6	Nr. 7
0056.103	PH 1 x 30 - 4,5	Nr. 7



**0068.010** 500 x 770 x 450  
**0068.210** vuoto - empty



23500  
8700



8 011578 000004  
8011578956479  
8011578949167



**70**

**ESPOSITORE 477 GIRAVITI - metallo**  
**DISPLAY STAND 477 SCREWDRIVERS - metal**

mm 500

Contenuto-content:

0050.307	3,0 x 0,5 x 75	Nr. 9
0050.410	4,0 x 0,8 x 100	Nr. 8
0050.412	4,0 x 0,8 x 125	Nr. 8
0050.512	5,5 x 1,0 x 125	Nr. 8
0050.612	6,5 x 1,2 x 125	Nr. 7
0050.615	6,5 x 1,2 x 150	Nr. 7
0050.815	8,0 x 1,2 x 150	Nr. 6
0051.256	2,5 x 0,4 x 60	Nr. 9
0051.310	3,0 x 0,5 x 100	Nr. 9
0051.415	4,0 x 0,8 x 150	Nr. 8
0051.515	5,0 x 1,0 x 150	Nr. 8
0055.403	5,0 x 0,8 x 38	Nr. 7
0055.603	6,5 x 1,0 x 38	Nr. 7

0052.010	PH 0 x 100 - 3	Nr. 9
0052.108	PH 1 x 80 - 4,5	Nr. 8
0052.112	PH 1 x 125 - 4,5	Nr. 8
0052.210	PH 2 x 100 - 6	Nr. 7
0052.215	PH 2 x 150 - 6	Nr. 7
0052.315	PH 3 x 150 - 8	Nr. 6
0053.006	PZ 0 x 60 - 3	Nr. 9
0053.108	PZ 1 x 80 - 5	Nr. 8
0053.210	PZ 2 x 100 - 6	Nr. 7
0053.315	PZ 3 x 150 - 8	Nr. 6
0056.103	PH 1 x 38 - 4,5	Nr. 7
0056.203	PH 2 x 38 - 6	Nr. 7
0057.103	PZ 1 x 38 - 4,5	Nr. 7

0075.060	TX 6 x 60	Nr. 9
0075.070	TX 7 x 60	Nr. 9
0075.080	TX 8 x 60	Nr. 9
0075.090	TX 9 x 60	Nr. 9
0075.100	TX 10 x 80	Nr. 8
0075.150	TX 15 x 80	Nr. 8
0075.200	TX 20 x 100	Nr. 8
0075.250	TX 25 x 100	Nr. 8
0075.270	TX 27 x 100	Nr. 8
0075.300	TX 30 x 100	Nr. 7
0075.400	TX 40 x 125	Nr. 6
0075.450	TX 45 x 125	Nr. 6
0084.010	1/4" x 100	Nr. 6

0090.258	2,5 x 0,4 x 80	Nr. 9
0090.310	3,0 x 0,5 x 100	Nr. 9
0090.410	4,0 x 0,8 x 100	Nr. 8
0090.512	5,5 x 1,0 x 125	Nr. 8
0090.615	6,5 x 1,2 x 150	Nr. 7
0090.817	8,0 x 1,6 x 175	Nr. 6
0092.007	PH 0 x 75	Nr. 9
0092.110	PH 1 x 100	Nr. 8
0092.210	PH 2 x 100	Nr. 7
0092.315	PH 3 x 150	Nr. 6
0093.007	PZ 0 x 75	Nr. 9
0093.110	PZ 1 x 100	Nr. 8
0093.210	PZ 2 x 100	Nr. 7

0082.050	5	Nr. 6
0082.055	5,5	Nr. 6
0082.060	6	Nr. 6
0082.070	7	Nr. 12
0082.080	8	Nr. 6
0082.090	9	Nr. 6
0082.100	10	Nr. 6
0082.110	11	Nr. 6
0082.120	12	Nr. 6
0082.130	13	Nr. 6
0058.430	4,0 x 0,8 x 300	Nr. 6
0059.130	PH 1 x 300 - 5	Nr. 6



—L—

**0070.010** 500 x 770 x 2000  
**0070.210** vuoto - empty



68900  
 30300



801157896509  
 8011578949181



**72**
**GIRAVITE PER VITI TORX - acciaio chrom-vanadium-molibdeno finitura cromata punta nera**  
**SCREWDRIVER FOR TORX HEAD SCREWS - chrom-vanadium-molybdenum steel chrome plated black finish tip**

HRC 60

Icona	X	Icona	Icona	Icona	Icona	Icona	Icona	Icona	Icona
0072.060	<b>TX 6 x 60</b>	87,5 x 25,4	28	<b>6</b>	8011578951382				
0072.070	<b>TX 7 x 60</b>	87,5 x 25,4	28	<b>6</b>	8011578951412				
0072.080	<b>TX 8 x 60</b>	87,5 x 25,4	28	<b>6</b>	8011578951443				
0072.090	<b>TX 9 x 60</b>	87,5 x 25,4	54	<b>6</b>	8011578951474				
0072.100	<b>TX 10 x 80</b>	109 x 31,7	56	<b>6</b>	8011578951504				
0072.150	<b>TX 15 x 80</b>	109 x 31,7	56	<b>6</b>	8011578951535				
0072.200	<b>TX 20 x 100</b>	109 x 31,7	60	<b>6</b>	8011578951566				
0072.250	<b>TX 25 x 100</b>	109 x 31,7	66	<b>6</b>	8011578951597				
0072.270	<b>TX 27 x 100</b>	109 x 31,7	66	<b>6</b>	8011578951627				
0072.300	<b>TX 30 x 100</b>	117 x 34,0	86	<b>6</b>	8011578951658				
0072.400	<b>TX 40 x 125</b>	127 x 36,9	136	<b>6</b>	8011578951689				
0072.450	<b>TX 45 x 125</b>	127 x 36,9	136	<b>6</b>	8011578951719				

**73**
**SERIE 5 GIRAVITI TORX - cartone**  
**SET 5 TORX SCREWDRIVERS - box**

Contenuto-content:

0072.100 TX 10 x 80  
 0072.150 TX 15 x 80  
 0072.200 TX 20 x 100  
 0072.250 TX 25 x 100  
 0072.300 TX 30 x 100

Icona	Icona	Icona	Icona
0073.010	310 x 180 x 37	476	8011578956530

**74**
**ESPOSITORE 101 GIRAVITI TORX - metallo**  
**DISPLAY STAND 101 TORX SCREWDRIVERS - metal**

Contenuto-content:

0072.060	TX 6 x 60	Nr. 9	0072.250	TX 25 x 100	Nr. 8
0072.070	TX 7 x 60	Nr. 9	0072.270	TX 27 x 100	Nr. 8
0072.080	TX 8 x 60	Nr. 9	0072.300	TX 30 x 100	Nr. 7
0072.090	TX 9 x 60	Nr. 9	0072.400	TX 40 x 125	Nr. 6
0072.100	TX 10 x 80	Nr. 8	0072.450	TX 45 x 125	Nr. 6
0072.150	TX 15 x 80	Nr. 8	0084.010	1/4" x 100	Nr. 6
0072.200	TX 20 x 100	Nr. 8			

Icona	Icona	Icona	Icona
0074.010	500 x 280 x 450	13308	8011578956561
0074.210	vuoto - empty	6800	8011578949204

**75**
**GIRAVITE PER VITI TORX CON FORO - acciaio chrom-vanadium-molibdeno finitura cromata punta nera**  
**SCREWDRIVER FOR TORX WITH HOLE HEAD SCREWS - chrom-vanadium-molybdenum steel chrome plated black finish tip**

HRC 60

Icona	X	Icona	Icona	Icona	Icona	Icona	Icona	Icona	Icona
0075.060	<b>TX 6 x 60</b>	87,5 x 25,4	28	<b>6</b>	8011578951740				
0075.070	<b>TX 7 x 60</b>	87,5 x 25,4	28	<b>6</b>	8011578951771				
0075.080	<b>TX 8 x 60</b>	87,5 x 25,4	30	<b>6</b>	8011578951801				
0075.090	<b>TX 9 x 60</b>	109 x 31,7	56	<b>6</b>	8011578951832				
0075.100	<b>TX 10 x 80</b>	109 x 31,7	58	<b>6</b>	8011578951863				
0075.150	<b>TX 15 x 80</b>	109 x 31,7	60	<b>6</b>	8011578951894				
0075.200	<b>TX 20 x 100</b>	109 x 31,7	62	<b>6</b>	8011578951924				
0075.250	<b>TX 25 x 100</b>	109 x 31,7	70	<b>6</b>	8011578951955				
0075.270	<b>TX 27 x 100</b>	109 x 31,7	66	<b>6</b>	8011578951986				
0075.300	<b>TX 30 x 100</b>	117 x 34,0	88	<b>6</b>	8011578952013				
0075.400	<b>TX 40 x 125</b>	127 x 36,9	138	<b>6</b>	8011578952044				
0075.450	<b>TX 45 x 125</b>	127 x 36,9	138	<b>6</b>	8011578952075				



**76**

**SERIE 5 GIRAVITI TORX CON FORO - cartone**  
**SET 5 TORX SCREWDRIVERS WITH HOLE - box**



Contenuto-content:

- 0075.100 TX 10 x 80
- 0075.150 TX 15 x 80
- 0075.200 TX 20 x 100
- 0075.250 TX 25 x 100
- 0075.300 TX 30 x 100

			
<b>0076.010</b>	310 x 180 x 37	476	8011578956592



**77**

**ESP. 101 GIRAVITI TORX CON FORO - metallo**  
**DISP. STAND 101 TORX SCREWDRIVERS WITH HOLE - metal**



Contenuto-content:

0075.060 TX 6 x 60	Nr. 9	0075.250 TX 25 x 100	Nr. 8
0075.070 TX 7 x 60	Nr. 9	0075.270 TX 27 x 100	Nr. 8
0075.080 TX 8 x 60	Nr. 9	0075.300 TX 30 x 100	Nr. 7
0075.090 TX 9 x 60	Nr. 9	0075.400 TX 40 x 125	Nr. 6
0075.100 TX 10 x 80	Nr. 8	0075.450 TX 45 x 125	Nr. 6
0075.150 TX 15 x 80	Nr. 8	0084.010 1/4" x 100	Nr. 6
0075.200 TX 20 x 100	Nr. 8		





			
<b>0077.010</b>	500 x 280 x 450	13000	8011578956622
<b>0077.210</b>	vuoto - empty	6800	8011578949228



**78**

**CHIAVE MASCHIO ESAGONALE SFERICA - acciaio chrom-vanadium-molibdeno finitura cromata punta nera**  
**SPHERICAL HEXAGONAL MALE WRENCH - chrom-vanadium-molybdenum steel chrome plated black finish tip**

HRC 60





				
<b>0078.025</b>	<b>2,5 x 75</b>	87,5 x 25,4	28	<b>6</b> 8011578952082
<b>0078.030</b>	<b>3,0 x 75</b>	87,5 x 25,4	28	<b>6</b> 8011578952105
<b>0078.040</b>	<b>4,0 x 100</b>	109 x 31,7	60	<b>6</b> 8011578952136
<b>0078.050</b>	<b>5,0 x 100</b>	109 x 31,7	70	<b>6</b> 8011578952167
<b>0078.060</b>	<b>6,0 x 125</b>	117 x 34,0	94	<b>6</b> 8011578952198



**80**

**CHIAVE MASCHIO QUADRATA**  
**SQUARE MALE WRENCH**

HRC 60

				
<b>0080.100</b>	<b>SQ1 x 100 x 4</b>	109 x 31,7	58	<b>12</b> 8011578952228
<b>0080.200</b>	<b>SQ2 x 125 x 5</b>	109 x 31,7	70	<b>12</b> 8011578952259
<b>0080.300</b>	<b>SQ3 x 150 x 6</b>	117 x 34,0	96	<b>6</b> 8011578952280











**82**

**CHIAVE A BUSSOLA ESAGONO FORO PROFONDO**  
**DEEP HOLE HEXAGON SOCKET**



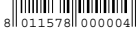



						
<b>0082.050</b>	<b>5,0 x 37 x 150</b>	117 x 34	118	<b>6</b>		8011578952310
<b>0082.055</b>	<b>5,5 x 37 x 150</b>	117 x 34	118	<b>6</b>		8011578952341
<b>0082.060</b>	<b>6,0 x 37 x 150</b>	117 x 34	118	<b>6</b>		8011578952372
<b>0082.070</b>	<b>7,0 x 72 x 150</b>	117 x 34	136	<b>6</b>		8011578952402
<b>0082.080</b>	<b>8,0 x 72 x 150</b>	117 x 34	126	<b>6</b>		8011578952433
<b>0082.090</b>	<b>9,0 x 72 x 150</b>	117 x 34	128	<b>6</b>		8011578952464
<b>0082.100</b>	<b>10,0 x 72 x 150</b>	117 x 34	126	<b>6</b>		8011578952495
<b>0082.110</b>	<b>11,0 x 72 x 150</b>	117 x 34	158	<b>6</b>		8011578952525
<b>0082.120</b>	<b>12,0 x 72 x 150</b>	117 x 34	146	<b>6</b>		8011578952556
<b>0082.130</b>	<b>13,0 x 72 x 150</b>	117 x 34	152	<b>6</b>		8011578952587



**83**

**SERIE 10 CHIAVI BUSSOLA FORO PROFONDO - scatola**  
**SET 10 DEEP HOLE SOCKETS - box**



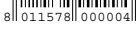



	Contenuto-content:		
	0082.050	0082.080	
	0082.055	0082.090	
	0082.060	0082.100	
	0082.070	0082.110	
			
<b>0083.010</b>	5 ÷ 13	1578	8011578956653

**83A**

**ESPOSITORE 78 CHIAVI BUSSOLA**  
**DISPLAY STAND 78 DEEP HOLE SOCKETS**



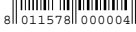



	Contenuto-content:					
	0082.050	5 x 37	Nr. 6	0082.100	10 x 72	Nr. 6
	0082.055	5,5 x 37	Nr. 6	0082.110	11 x 72	Nr. 6
	0082.060	6 x 37	Nr. 6	0082.120	12 x 72	Nr. 6
	0082.070	7 x 72	Nr. 12	0082.130	13 x 72	Nr. 6
	0082.080	8 x 72	Nr. 6	0084.010	1/4" x 100	Nr. 6
	0082.090	9 x 72	Nr. 6	0087.010	1/4" x 190	Nr. 6
						
<b>0083.110</b>	500 x 280 x 450	17220	8011578956684			
<b>0083.210</b>	vuoto - empty	6800	8011578949242			

**84**

**PORTAINSERTI MAGNETICO ATTACCO 1/4"**  
**MAGNETIC BIT HOLDER 1/4"**



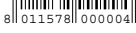





	<b>1/4"</b>					
						
<b>0084.010</b>	1/4"	100	117 x 34	100	<b>6</b>	8011578952648

**87**

**PORTAINSERTI MAGNETICO FLESSIBILE ATTACCO 1/4"**  
**FLEXIBLE MAGNETIC BIT HOLDER 1/4"**



	<b>1/4"</b>					
						
<b>0087.010</b>	1/4"	190	117 x 34	154	<b>6</b>	8011578952679
<b>0087.310</b>		con 6 bit	117 x 34	190	<b>2</b>	8011578960728



**90**

**GIRAVITE ISOLATO 1000 volt VDE - PER VITI INTAGLIO - acciaio chrom-vanadium-molibdeno finitura punta nera**  
**INSULATED SCREWDRIVER 1000 volt VDE - FOR SLOTTED HEAD - chrom-vanadium-molybdenum steel black finish tip**

**GOMMOGRIP**  
**MUNDIAL**

**Impugnatura morbida bicomponente.**  
**Soft bicomponent handle.**

 **60900**



HRC 60

Model	Tip Size (mm)	Length (mm)	Weight (g)	Material	Barcode
0090.258	2,5 x 0,4 x 80	87,5 x 25,4	28	6	8011578952709
0090.310	3,0 x 0,5 x 100	87,5 x 25,4	32	6	8011578952730
0090.410	4,0 x 0,8 x 100	109 x 31,7	60	6	8011578952761
0090.512	5,5 x 1,0 x 125	109 x 31,7	46	6	8011578952792
0090.615	6,5 x 1,2 x 150	117 x 34,0	104	6	8011578952822
0090.817	8,0 x 1,6 x 175	127 x 36,9	156	6	8011578952853

Ridotto - Recessed



Ridotto - Recessed  
 Ridotto - Recessed

**92**

**GIRAVITE ISOLATO 1000 volt VDE - PER VITI CROCE PHILLIPS**  
**INSULATED SCREWDRIVER 1000 volt VDE - FOR PHILLIPS CROSS**

HRC 60

Model	Tip Size (mm)	Length (mm)	Weight (g)	Material	Barcode
0092.007	PH 0 x 75	87,5 x 25,4	30	6	8011578952884
0092.110	PH 1 x 100	109 x 31,7	70	6	8011578952914
0092.210	PH 2 x 100	117 x 34,0	86	6	8011578952945
0092.315	PH 3 x 150	127 x 36,9	146	6	8011578952976



Ridotto - Recessed  
 Ridotto - Recessed



 **60900**

**93**

**GIRAVITE ISOLATO 1000 volt VDE - PER VITI CROCE POZIDRIV**  
**INSULATED SCREWDRIVER 1000 volt VDE - FOR POZIDRIV CROSS**

HRC 60

Model	Tip Size (mm)	Length (mm)	Weight (g)	Material	Barcode
0093.007	PZ 0 x 75	87,5 x 25,4	28	6	8011578953003
0093.110	PZ 1 x 100	109 x 31,7	68	6	8011578953034
0093.210	PZ 2 x 100	117 x 34,0	88	6	8011578953065
0093.315	PZ 3 x 150	127 x 36,9	142	6	8011578953096



Ridotto - Recessed  
 Ridotto - Recessed



 **60900**

**94**

**SERIE 5 GIRAVITI ISOLATI 1000 volt VDE - cartone**  
**SET 5 INSULATED SCREWDRIVERS 1000 Volt VDE - box**

Contenuto-content:

- 0090.310 3,0 x 0,5 x 100
- 0090.410 4,0 x 0,8 x 100
- 0090.512 5,5 x 1,0 x 125
- 0092.110 PH 1 x 100
- 0092.210 PH 2 x 100

 **60900**



Model	Dimensions (mm)	Weight (g)	Barcode
0094.010	310 x 180 x 37	474	8011578956714



**95**
**SERIE 7 GIRAVITI ISOLATI 1000 volt VDE - cartone**  
 SET 7 INSULATED SCREWDRIVERS 1000 Volt VDE - box

Contenuto-content:

0090.310 3,0 x 0,5 x 100  
 0090.410 4,0 x 0,8 x 100  
 0090.512 5,5 x 1,0 x 125  
 0090.615 6,5 x 1,2 x 150  
 0092.007 PH 0 x 75  
 0092.110 PH 1 x 100  
 0092.210 PH 2 x 100

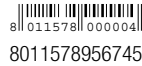

 0095.010 330 x 220 x 40



 646
**96**
**ESPOSITORE 101 GIRAVITI ISOLATI 1000 volt VDE - metallo**  
 DISPLAY STAND 101 INSULATED SCREWDRIVERS 1000 volt VDE - metal

Contenuto-content:

0090.258 2,5 x 0,4 x 80 Nr. 9  
 0090.310 3,0 x 0,5 x 100 Nr. 9  
 0090.410 4,0 x 0,8 x 100 Nr. 8  
 0090.512 5,5 x 1,0 x 125 Nr. 8  
 0090.615 6,5 x 1,2 x 150 Nr. 7  
 0090.817 8,0 x 1,6 x 175 Nr. 6  
 0092.007 PH 0 x 75 Nr. 9  
 0092.110 PH 1 x 100 Nr. 8  
 0092.210 PH 2 x 100 Nr. 7  
 0092.315 PH 3 x 150 Nr. 6  
 0093.007 PZ 0 x 75 Nr. 9  
 0093.110 PZ 1 x 100 Nr. 8  
 0093.210 PZ 2 x 100 Nr. 7

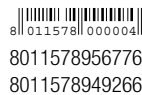

 0096.010 500 x 280 x 450  
 0096.210 vuoto - empty

 14200  
 6800
**730**
**ESPOSITORE GIRAVITI E PINZE ISOLATE 1000 volt VDE**  
 DISPLAY INSULATED SCREWDRIVERS AND PLIERS 1000 volt VDE

Contenuto-content:

0090.258 2,5 x 0,4 x 80 Nr. 9  
 0090.310 3,0 x 0,5 x 100 Nr. 9  
 0090.410 4,0 x 0,8 x 100 Nr. 8  
 0090.512 5,5 x 1,0 x 125 Nr. 8  
 0090.615 6,5 x 1,2 x 150 Nr. 7  
 0090.817 8,0 x 1,6 x 175 Nr. 6  
 0092.007 PH 0 x 75 Nr. 9  
 0092.110 PH 1 x 100 Nr. 8  
 0092.210 PH 2 x 100 Nr. 7  
 0092.315 PH 3 x 150 Nr. 6  
 0093.007 PZ 0 x 75 Nr. 9  
 0093.110 PZ 1 x 100 Nr. 8  
 0093.210 PZ 2 x 100 Nr. 7  
 0710.018 Nr. 6  
 0710.020 Nr. 6  
 0712.016 Nr. 6  
 0712.020 Nr. 6  
 0714.020 Nr. 6  
 0716.016 Nr. 6

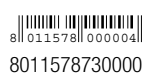

 0730.010 475 x 215 x 600

 29250

**115** GIRAVITE PER VITI INTAGLIO-MECCANICI - acciaio chrom-vanadium finitura brunita - impugnatura in acetato  
 SCREWDRIVER FOR SLOTTED HEAD SCREWS-MECHANIC - chrom-vanadium steel black finish - acetate handle



DIN 5265 ISO 2380

Icona	Modello	Dimensioni	Spessore	Spessore	Spessore	Spessore	Spessore	Spessore	Spessore	Spessore
	0115.206	2,0 x 0,4 x 60	60 x 12	7	12	8011578900014				
	0115.256	2,5 x 0,4 x 60	60 x 12	8	12	8011578900045				
	0115.307	3,0 x 0,5 x 75	69 x 16	18	12	8011578900106				
	0115.310	3,0 x 0,5 x 100	69 x 16	18	12	8011578900137				
	0115.410	4,0 x 0,8 x 100	93 x 21	42	12	8011578900199				
	0115.512	5,5 x 1,0 x 125	93 x 21	52	12	8011578900281				
	0115.612	6,5 x 1,2 x 125	102 x 24	76	12	8011578900373				
	0115.615	6,5 x 1,2 x 150	102 x 24	78	12	8011578900403				
	0115.815	8,0 x 1,2 x 150	114 x 28	140	6	8011578900434				
	0115.920	10,0 x 1,6 x 200	128 x 34	264	6	8011578900496				

**116** GIRAVITE PER VITI CROCE PHILLIPS - acciaio chrom-vanadium finitura brunita - impugnatura in acetato  
 SCREWDRIVER FOR PHILLIPS CROSS HEAD SCREWS - chrom-vanadium steel black finish - acetate handle



DIN 5262 ISO 8764

Icona	Modello	Dimensioni	Spessore	Spessore	Spessore	Spessore	Spessore
	0116.002	PH 00 x 60 x 2,0	60 x 12	8	12	8011578900526	
	0116.006	PH 0 x 60 x 3,0	69 x 16	16	12	8011578900557	
	0116.010	PH 0 x 100 x 3,0	69 x 16	18	12	8011578900588	
	0116.108	PH 1 x 80 x 4,5	93 x 21	42	12	8011578900618	
	0116.112	PH 1 x 125 x 4,5	93 x 21	48	12	8011578900649	
	0116.210	PH 2 x 100 x 6,0	102 x 24	70	12	8011578900670	
	0116.215	PH 2 x 150 x 6,0	102 x 24	80	12	8011578900700	
	0116.315	PH 3 x 150 x 8,0	114 x 28	138	6	8011578900731	

**137A** GIRAVITE PER VITI INTAGLIO - acciaio chrom-vanadium finitura cromata - impugnatura in acetato  
 SCREWDRIVER FOR SLOTTED HEAD SCREWS - chrom-vanadium steel chrome plated finish - acetate handle

EX 118A



DIN 5265 ISO 2380

Icona	Modello	Dimensioni	Spessore	Spessore	Spessore	Spessore
	0137.140	4,0 x 0,8 x 30	52 x 30	32	12	8011578902445
	0137.160	6,5 x 1,2 x 30	52 x 30	40	12	8011578902476



**137B** GIRAVITE PER VITI CROCE PHILLIPS  
 SCREWDRIVER PHILLIPS CROSS HEAD SCREWS

EX 118B



DIN 5262 ISO 8764

Icona	Modello	Dimensioni	Spessore	Spessore	Spessore	Spessore
	0137.210	PH 1 x 30 x 4,5	52 x 30	34	12	8011578902506
	0137.220	PH 2 x 30 x 6,0	52 x 30	40	12	8011578902537



**119C**
**SERIE 5 GIRAVITI - cartone**  
 SET 5 SCREWDRIVERS - box

Contenuto-content:

 0115.307 3 x 75  
 0115.410 4 x 100  
 0115.612 6 x 125  
 0116.108 PH 1 x 80  
 0116.210 PH 2 x 100



 0119.310 310 x 180 x 37

 396



 8011578119157
**119D**
**SERIE 7 GIRAVITI - cartone**  
 SET 7 SCREWDRIVERS - box

Contenuto-content:

 0115.307 3 x 75  
 0115.410 4 x 100  
 0115.510 5 x 125  
 0115.612 6 x 125  
 0116.006 PH 0 x 60  
 0116.108 PH 1 x 80  
 0116.210 PH 2 x 100



 0119.410 330 x 220 x 40

 506

 8011578119171
**121**
**ESPOSITORE 98 GIRAVITI - metallo**  
 DISPLAY STAND 98 SCREWDRIVERS - metal

Contenuto-content:

 0115.206 2 x 60 Nr. 9  
 0115.307 3 x 75 Nr. 9  
 0115.410 4 x 100 Nr. 14  
 0115.512 5 x 125 Nr. 14  
 0115.612 6 x 125 Nr. 12  
 0115.815 8 x 150 Nr. 6  
 0116.006 PH 0 x 60 Nr. 9  
 0116.108 PH 1 x 80 Nr. 7  
 0116.210 PH 2 x 100 Nr. 6  
 0137.160 6 x 30 Nr. 6  
 0137.210 PH 1 x 30 Nr. 6

 0121.010 410 x 230 x 200  
 0121.210 vuoto - empty



 9370  
 4700

 8011578121051  
 8011578121105

**130** GIRAVITE PER VITI INTAGLIO-MECCANICI - acciaio chrom-vanadium finitura cromata - impugnatura in acetato  
 SCREWDRIVER FOR SLOTTED HEAD SCREWS-MECHANIC - chrom-vanadium steel chrome plated finish - acetate handle

DIN 5265 ISO 2380

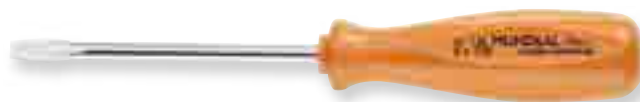
Icona	Modello	Spessore X	Lunghezza	Spessore	Capacità	Icona	Barcode	Numero
	0130.307	3,0 x 0,5 x 75	77 x 21	25	12			8011578901424
	0130.310	3,0 x 0,5 x 100	77 x 21	25	12			8011578901455
	0130.410	4,0 x 0,8 x 100	91 x 25	50	12			8011578901516
	0130.412	4,0 x 0,8 x 125	91 x 25	50	12			8011578901547
	0130.510	5,5 x 1,0 x 100	91 x 25	60	12			8011578901608
	0130.512	5,5 x 1,0 x 125	91 x 25	60	12			8011578901639
	0130.515	5,5 x 1,0 x 150	91 x 25	64	12			8011578901660
	0130.610	6,5 x 1,2 x 100	106 x 30	100	12			8011578901691
	0130.612	6,5 x 1,2 x 125	106 x 30	100	12			8011578901721
	0130.615	6,5 x 1,2 x 150	106 x 30	104	12			8011578901752
	0130.815	8,0 x 1,2 x 150	115 x 34	170	6			8011578901783



**132** GIRAVITE PER VITI INTAGLIO-LAME PARALLELE - acciaio chrom-vanadium finitura cromata - impugnatura in acetato  
 SCREWDRIVER FOR SLOTTED HEAD SCREWS-CABINET - chrom-vanadium steel chrome plated finish - acetate handle

DIN 5265 ISO 2380

Icona	Modello	Spessore X	Lunghezza	Spessore	Capacità	Icona	Barcode	Numero
	0132.310	3 x 0,5 x 100	77 x 21	25	12			8011578901844
	0132.415	4 x 0,8 x 150	91 x 25	53	12			8011578901905
	0132.515	5 x 1,0 x 150	91 x 25	60	12			8011578901967



**135** GIRAVITE PER VITI CROCE PHILLIPS - acciaio chrom-vanadium finitura cromata - impugnatura in acetato  
 SCREWDRIVER FOR PHILLIPS CROSS HEAD SCREWS - chrom-vanadium steel chrome plated finish - acetate handle

DIN 5262 ISO 8764

Icona	Modello	Spessore X	Lunghezza	Spessore	Capacità	Icona	Barcode	Numero
	0135.006	PH 0 x 60 x 3,0	77 x 21	24	12			8011578902056
	0135.010	PH 0 x 100 x 3,0	77 x 21	26	12			8011578902087
	0135.108	PH 1 x 80 x 4,5	91 x 25	52	12			8011578902117
	0135.112	PH 1 x 125 x 4,5	91 x 25	58	12			8011578902148
	0135.210	PH 2 x 100 x 6,0	106 x 30	94	12			8011578902179
	0135.215	PH 2 x 150 x 6,0	106 x 30	104	12			8011578902209
	0135.315	PH 3 x 150 x 8,0	115 x 34	172	6			8011578902230



**136** GIRAVITE PER VITI CROCE POZIDRIV - acciaio chrom-vanadium finitura cromata - impugnatura in acetato  
 SCREWDRIVER FOR POZIDRIV CROSS HEAD SCREWS - chrom-vanadium steel chrome plated finish - acetate handle

DIN 5262 ISO 8764

Icona	Modello	Spessore X	Lunghezza	Spessore	Capacità	Icona	Barcode	Numero
	0136.006	PZ 0 x 60 x 3,0	77 x 21	24	12			8011578902261
	0136.108	PZ 1 x 80 x 4,5	91 x 25	52	12			8011578902292
	0136.112	PZ 1 x 125 x 4,5	91 x 25	56	12			8011578902322
	0136.210	PZ 2 x 100 x 6,0	106 x 30	94	12			8011578902353
	0136.215	PZ 2 x 150 x 6,0	106 x 30	104	12			8011578902384
	0136.315	PZ 3 x 150 x 8,0	115 x 34	172	6			8011578902414



**137A** GIRAVITE PER VITI INTAGLIO - acciaio chrom-vanadium finitura cromata - impugnatura in acetato  
 SCREWDRIVER FOR SLOTTED HEAD SCREWS - chrom-vanadium steel chrome plated finish - acetate handle

EX 118A DIN 5265 ISO 2380

Icona	Modello	Spessore X	Lunghezza	Spessore	Capacità	Icona	Barcode	Numero
	0137.140	4,0 x 0,8 x 30	52 x 30	32	12			8011578902445
	0137.160	6,5 x 1,2 x 30	52 x 30	40	12			8011578902476



## 137B

### GIRAVITE PER VITI CROCE PHILLIPS SCREWDRIVER PHILLIPS CROSS HEAD SCREWS

EX 118B



DIN 5262 ISO 8764

<b>0137.210</b>	<b>PH 1 x 30 x 4,5</b>	52 x 30	34	<b>12</b>	8011578902506		
<b>0137.220</b>	<b>PH 2 x 30 x 6,0</b>	52 x 30	40	<b>12</b>	8011578902537		

## 137C

### GIRAVITE PER VITI CROCE POZIDRIV SCREWDRIVER POZIDRIV CROSS HEAD SCREWS

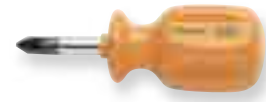

DIN 5262 ISO 8764

<b>0137.310</b>	<b>PZ 1 x 30 x 4,5</b>	52 x 30	34	<b>12</b>	8011578902568		
<b>0137.320</b>	<b>PZ 2 x 30 x 6,0</b>	52 x 30	40	<b>12</b>	8011578902599		

## 138

### GIRAVITE PER VITI INTAGLIO SERIE LUNGA - acciaio chrom-vanadium finitura cromata - impugnatura in acetato SCREWDRIVER FOR SLOTTED HEAD SCREWS LONG TYPE - chrom-vanadium steel chrome plated finish - acetate handle



<b>0138.325</b>	<b>3 x 0,5 x 250</b>	77 x 21	34	<b>6</b>	8011578902681		
<b>0138.430</b>	<b>4 x 0,8 x 300</b>	91 x 25	68	<b>6</b>	8011578902742		
<b>0138.630</b>	<b>6 x 1,2 x 300</b>	106 x 30	132	<b>6</b>	8011578902803		



## 139

### GIRAVITE PER VITI CROCE PHILLIPS SERIE LUNGA - acciaio chrom-vanadium finitura cromata - impugnatura in acetato SCREWDRIVER FOR PHILLIPS CROSS HEAD SCREWS LONG TYPE - chrom-vanadium steel chrome plated finish - acetate handle



<b>0139.025</b>	<b>PH 0 x 250 x 3,0</b>	77 x 21	34	<b>6</b>	8011578902834		
<b>0139.130</b>	<b>PH 1 x 300 x 4,5</b>	91 x 25	76	<b>6</b>	8011578902896		
<b>0139.230</b>	<b>PH 2 x 300 x 6,0</b>	106 x 30	132	<b>6</b>	8011578902957		



## 147C

### SERIE 5 GIRAVITI - cartone SET 5 SCREWDRIVERS - box

Contenuto-content:

0130.307	3 x 75	0135.108	PH 1 x 80
0130.410	4 x 100	0135.210	PH 2 x 100
0130.612	6 x 125		

<b>0147.310</b>	310 x 180 x 37	468	8011578147051			



## 147D

### SERIE 7 GIRAVITI - cartone SET 7 SCREWDRIVERS - box

Contenuto-content:

0130.307	3 x 75	0135.006	PH 0 x 60
0130.410	4 x 100	0135.108	PH 1 x 80
0130.510	5 x 100	0135.210	PH 2 x 100
0130.612	6 x 125		

<b>0147.410</b>	330 x 220 x 40	588	8011578147099			



## 148

### ESPOSITORE 98 GIRAVITI - metallo DISPLAY STAND 98 SCREWDRIVERS - metal

Contenuto-content:









0130.307	3 x 75	Nr. 9	0130.612	6 x 125	Nr. 6
0130.310	3 x 100	Nr. 9	0130.815	8 x 150	Nr. 6
0130.410	4 x 100	Nr. 7	0135.006	PH 0 x 60	Nr. 9
0130.412	4 x 125	Nr. 7	0135.108	PH 1 x 80	Nr. 7
0130.510	5 x 100	Nr. 7	0135.210	PH 2 x 100	Nr. 6
0130.512	5 x 125	Nr. 7	0137.160	6 x 30	Nr. 6
0130.610	6 x 100	Nr. 6	0137.210	PH 1 x 30	Nr. 6

<b>0148.010</b>	410 x 230 x 200	10500	8011578148058			
<b>0148.210</b>	vuoto - empty	4600	8011578148102			











**162** GIRAVITE PER VITI INTAGLIO - elettronica - acciaio chrom-vanadium finitura nichelata punta nera - impugnatura in acetato  
 SCREWDRIVER FOR SLOTTED HEAD SCREWS - electronics - chrom-vanadium steel nickel plated black finished tip - acetate handle

DIN 5265 ISO 2380









							
0162.105	1,5 x 0,3 x 50	88 x 16	15	12	8011578904661		
0162.206	2,0 x 0,4 x 50	88 x 16	15	12	8011578904692		
0162.207	2,5 x 0,4 x 50	88 x 16	15	12	8011578904722		
0162.310	3,0 x 0,5 x 50	88 x 16	15	12	8011578904753		

**163** GIRAVITE PER VITI CROCE PHILLIPS - elettronica - acciaio chrom-vanadium finitura nichelata punta nera - impugnatura in acetato  
 SCREWDRIVER FOR PHILLIPS CROSS HEAD SCREWS - electronics - chrom-vanadium steel nickel plated black finished tip - acetate handle

DIN 5262 ISO 8764

							
0163.005	PH 000 x 50 x 2,5	88 x 16	15	12	8011578904814		
0163.006	PH 00 x 50 x 3,0	88 x 16	15	12	8011578904845		
0163.015	PH 0 x 50 x 3,0	88 x 16	15	12	8011578904876		

**163X** GIRAVITE PER ELETTRONICA - per viti torx  
 SCREWDRIVER FOR ELECTRONIC - torx-head screws

							
0163.906	TX 6 x 50	82 x 16	13	12	8011578933265		
0163.907	TX 7 x 50	82 x 16	13	12	8011578933289		
0163.908	TX 8 x 50	82 x 16	13	12	8011578933302		
0163.909	TX 9 x 50	82 x 16	13	12	8011578933326		
0163.910	TX 10 x 50	82 x 16	14	12	8011578933340		
0163.915	TX 15 x 50	82 x 16	16	12	8011578933364		
0163.920	TX 20 x 50	82 x 16	18	12	8011578933388		

**164** SERIE 7 GIRAVITI INTAGLIO E CROCE  
 SET 7 SCREWDRIVERS SLOT AND CROSS

Contenuto-content:

- 0162.105 1,5 x 50
- 0162.206 2 x 50
- 0162.207 2,5 x 50
- 0162.310 3 x 50
- 0163.005 PH 000 x 50
- 0163.006 PH 00 x 50
- 0163.015 PH 0 x 50



			
0164.010	170 x 130 x 25	214	8011578164003

**164X** SERIE 7 GIRAVITI TORX  
 SET 7 TORX SCREWDRIVERS

Contenuto-content:

- 0163.906 6 x 50
- 0163.907 7 x 50
- 0163.908 8 x 50
- 0163.909 9 x 50
- 0163.910 10 x 50
- 0163.915 15 x 50
- 0163.920 20 x 50



			
0164.910	170 x 130 x 25	206	8011578164034

**177** SERIE 5 GIRAVITI - impugnatura bicomponente - intaglio - croce PH - termoformato  
 SET 5 SCREWDRIVERS - bicomponent handle - slotted - cross PH - thermoformed

Contenuto-content:

- 0170.410 4 x 100
- 0170.615 6 x 150
- 0172.007 PH 0 x 75
- 0172.108 PH 1 x 100
- 0172.210 PH 2 x 100

Espositore banco Pz. 12 - Table display Pz. 12







			
0177.010	315 x 135 x 40	410	8011578963125

new











**184** GIRAVITE PER VITI INTAGLIO - acciaio chrom-vanadium finitura nichelata - impugnatura in acetato  
 SCREWDRIVER FOR SLOTTED HEAD SCREWS - chrom-vanadium steel nickel plated finish - acetate handle

						
0184.307	3,0 x 0,5 x 75	69 x 16	16	12	8011578905293	
0184.407	4,0 x 0,8 x 75	93 x 21	40	12	8011578905323	
0184.510	5,5 x 1,0 x 100	93 x 21	52	12	8011578905354	
0184.612	6,5 x 1,2 x 125	102 x 24	76	12	8011578905385	









**186** GIRAVITE PER VITI CROCE PHILLIPS - acciaio chrom-vanadium finitura nichelata - impugnatura in acetato  
 SCREWDRIVER FOR PHILLIPS CROSS HEAD SCREWS - chrom-vanadium steel nickel plated finish - acetate handle

						
0186.006	PH 0 x 60 x 3,0	69 x 16	16	12	8011578905415	
0186.108	PH 1 x 80 x 4,5	93 x 21	42	12	8011578905446	
0186.210	PH 2 x 100 x 6,0	102 x 24	68	12	8011578905477	





**188** GIRAVITE PER VITI CROCE POZIDRIV - acciaio chrom-vanadium finitura nichelata - impugnatura in acetato  
 SCREWDRIVER FOR POZIDRIV CROSS HEAD SCREWS - chrom-vanadium steel nickel plated finish - acetate handle

						
0188.108	PZ 1 x 80 x 4,5	93 x 21	42	12	8011578905507	
0188.210	PZ 2 x 100 x 6,0	102 x 24	72	12	8011578905538	



**190** SERIE 6 GIRAVITI - termoformato  
 SET 6 SCREWDRIVERS - thermoformed





Contenuto-content:			
0184.307	3 x 75	0184.612	6 x 125
0184.407	4 x 75	0186.108	PH 1 x 80
0184.510	5 x 100	0186.210	PH 2 x 100

Espositore banco Pz. 12 - Table display Pz. 12

				
0190.010	240 x 90 x 27	320	12	8011578190002

**191A** SERIE 5 GIRAVITI - cartone  
 SET 5 SCREWDRIVERS - box







Contenuto-content:			
0184.307	3 x 75	0186.108	PH 1 x 80
0184.407	4 x 75	0186.210	PH 2 x 100
0184.612	6 x 125		

			
0191.010	310 x 180 x 27	392	8011578191108

**192** ESPOSITORE 144 GIRAVITI - cartone  
 DISPLAY STAND 144 SCREWDRIVERS - box





Contenuto-content:					
0184.307	3 x 75	Nr. 24	0184.612	6 x 125	Nr. 24
0184.407	4 x 75	Nr. 24	0186.108	PH 1 x 80	Nr. 24
0184.510	5 x 100	Nr. 24	0186.210	PH 2 x 100	Nr. 24

			
0192.010	470 x 260 x 100	6900	8011578192150

**193** ESPOSITORE 144 GIRAVITI - cartone  
 DISPLAY STAND 144 SCREWDRIVERS - box









Contenuto-content:					
0184.307	3 x 75	Nr. 24	0186.006	PH 0 x 60	Nr. 24
0184.407	4 x 75	Nr. 24	0186.108	PH 1 x 80	Nr. 24
0184.612	6 x 125	Nr. 24	0186.210	PH 2 x 100	Nr. 24

			
0193.010	470 x 260 x 100	6900	8011578193058









**206** GIRAVITE REVERSIBILE INTAGLIO-CROCE  
 REVERSIBLE SCREWDRIVER SLOTTED-CROSS



  X       
 0206.060 PH 2 x 60 x 6,0 90 x 20 48 12 8011578905682







**222** GIRAVITE CERCAFASE  
 CIRCUIT TESTER SCREWDRIVER



 X       
 0222.410 4 x 100 95 x 25 32 12 8011578943141

**223** GIRAVITE CERCAFASE  
 CIRCUIT TESTER SCREWDRIVER









 X       
 0223.306 3 x 60 88 x 21 20 12 8011578943165

**225** GIRAVITE CERCAFASE - chrom-vanadium - lama isolata  
 CIRCUIT TESTER SCREWDRIVER - chrom-vanadium - insulated blade









CE

 X       
 0225.410 4 x 0,8 x 100 90 x 18 34 12 8011578905897

**232** GIRAVITE CERCAFASE - chrom-vanadium - lama isolata  
 CIRCUIT TESTER SCREWDRIVER - chrom-vanadium - insulated blade



CE

 X       
 0232.306 3 x 0,5 x 60 75 x 15 22 12 8011578905927

**236** SERIE 10 INSERTI E PORTAINSERI  
 SET 10 BITS AND HOLDER



Contenuto-content:

0240.010	0250.200	PH 2 x 25
0249.400	4 x 25	0250.300 PH 3 x 25
0249.500	5 x 25	0251.100 PZ 1 x 25
0249.600	6 x 25	0251.200 PZ 2 x 25
0250.100	PH 1 x 25	0251.300 PZ 3 x 25



 **0236.010**   114 **10**  80115781 000004 8011578236052

**236.900** ESPOSITORE IN CARTONE 10 SERIE INSERTI E PORTAINSERI  
 CARTON DESK DISPLAY 10 SET BITS AND HOLDER



Contenuto-content:

0236.010 Nr. 10



 **0236.900**  260 x 260 x 260  2100  80115781 000004 8011578949488

**237** SERIE 25 INSERTI  
 SET 25 BITS

Contenuto-content:

0240.010	0251.300	PZ 3 x 25	0255.300	TX 30 x 25	
0249.400	4 x 25	0255.060	TX 6 x 25	0263.015	1,5 x 25
0249.500	5 x 25	0255.070	TX 7 x 25	0263.020	2 x 25
0249.600	6 x 25	0255.080	TX 8 x 25	0263.030	3 x 25
0250.100	PH 1 x 25	0255.090	TX 9 x 25	0263.040	4 x 25
0250.200	PH 2 x 25	0255.100	TX 10 x 25	0263.050	5 x 25
0250.300	PH 3 x 25	0255.150	TX 15 x 25	0263.060	6 x 25
0251.100	PZ 1 x 25	0255.200	TX 20 x 25		
0251.200	PZ 2 x 25	0255.250	TX 25 x 25		



 **0237.010**   192 **6**  80115781 000004 8011578237059



**238** PORTAUTENSILI 1/4" - magnetico - prendivite  
 HOLDER 1/4" - magnetic - Screw cap











 **0238.010**  1/4"  60  24  **6**  80115781 000004 8011578933401

**240** PORTAINSERI CON ANELLO 1/4" - magnetico  
 HOLDER WITH RING 1/4" - magnetic



DIN 7427

  1/4"  28  **6**  8011578960940  
**0240.010** 1/4" 75  36  **6** 8011578906016  
**0240.020** 1/4" 100  40  **6** 8011578946685











**239** PORTAUTENSILI 1/4" - sgancio rapido - magnetico  
 HOLDER 1/4" - quick release - magnetic



 **0239.010**  1/4"  60  30  **6**  80115781 000004 8011578933425

**241** ADATTATORE 1/4"  
 ADAPTER 1/4"



 **0241.014**  1/4" 50  15  **6**  8011578906047  
**0241.038**  3/8" 50  22  **6** 8011578906078  
**0241.120**  1/2" 50  25  **6** 8011578949501



**243** CHIAVE A BUSSOLA 1/4" - magnetica  
 NUTSETTERS 1/4" - magnetic

7424



Icon	Symbol	Length	Width	Material	Part No.
		45	18	6	8011578933449
		45	18	6	8011578933463
		45	22	6	8011578933487
		45	24	6	8011578933500
		45	26	6	8011578933524
		45	32	6	8011578933548
		45	32	6	8011578933562
		45	32	6	8011578965884

**244** CHIAVE A BUSSOLA 1/4" - lunga - magnetica  
 NUTSETTERS 1/4" - long - magnetic



Icon	Symbol	Length	Width	Material	Part No.
		100	22	6	8011578949525
		100	22	6	8011578949549
		100	23	6	8011578946760
		100	23	6	8011578946807
		100	24	6	8011578946845
		100	29	6	8011578946883
		100	37	6	8011578946944
		100	37	6	8011578947002

**245** INSERTO PHILLIPS 1/4" - lungo  
 BIT PHILLIPS HEAD SCREWS 1/4"



DIN 3128 ISO 1173

Icon	Symbol	Length	Width	Material	Part No.
		75	12	6	8011578906108
		90	14	6	8011578945688
		150	22	6	8011578945701
		75	15	6	8011578906139
		90	20	6	8011578945725
		150	34	6	8011578945749

**246** INSERTO POZIDRIV 1/4" - lungo  
 BIT POZIDRIV HEAD SCR. 1/4"



DIN 3128 ISO 1173

Icon	Symbol	Length	Width	Material	Part No.
		75	12	6	8011578906160
		90	14	6	8011578945763
		150	22	6	8011578945787
		75	15	6	8011578906191
		90	20	6	8011578945800
		150	34	6	8011578945824

**249** INSERTO PER VITI INTAGLIO 1/4"  
 BIT FOR SLOTTED HEAD SCREWS 1/4"



DIN 3127 ISO 2351

Icon	Symbol	Length	Width	Material	Part No.
		25	4	12	8011578906221
		25	4	100	8011578949846
		25	4	12	8011578906252
		25	4	100	8011578949860
		25	4	12	8011578906283
		25	4	100	8011578949884

**250** INSERTO CROCE PHILLIPS 1/4" - acciaio legato speciale  
 BIT PHILLIPS CROSS HEAD SCREWS 1/4" - sp. alloy steel



DIN 3128 ISO 1173

Icon	Symbol	Length	Width	Material	Part No.
		25	5	12	8011578906313
		25	5	100	8011578949907
		25	5	12	8011578906344
		25	5	100	8011578949921
		25	5	12	8011578906375
		25	5	100	8011578949945

**250T** INSERTO PER VITI CROCE PHILLIPS 1/4" - titanium  
 BIT PHILLIPS CROSS HEAD SCREWS 1/4" - titanium



DIN 3128 ISO 1173

Icon	Symbol	Length	Width	Material	Part No.
		25	5	12	8011578934125
		25	5	12	8011578934149
		25	5	12	8011578934163

**251** INSERTO CROCE POZIDRIV 1/4"  
 BIT PZ CROSS HEAD SCREWS 1/4"



DIN 3128 ISO 1173

Icon	Symbol	Length	Width	Material	Part No.
		25	5	12	8011578906405
		25	5	100	8011578949969
		25	5	12	8011578906436
		25	5	100	8011578949983
		25	5	12	8011578906467
		25	5	100	8011578960001

**251T** INSERTO CROCE POZIDRIV 1/4" - titanium  
 BIT PZ CROSS HEAD SCREWS 1/4" - titanium



DIN 3128 ISO 1173

Icon	Symbol	Length	Width	Material	Part No.
		25	4	12	8011578934187
		25	5	12	8011578934200
		25	5	12	8011578934224

## 253 INSERTO PER VITI TORX 1/4" BIT FOR TORX HEAD SCREWS 1/4"



Icona	Modello	Dimensione	Lunghezza	Materiali	Barcode
		T↔L↔			81157811000004
0253.060	TX 6	25	4	12	8011578947040
0253.070	TX 7	25	4	12	8011578947064
0253.080	TX 8	25	4	12	8011578906498
0253.090	TX 9	25	4	12	8011578906528
0253.100	TX 10	25	4	12	8011578906559
0253.150	TX 15	25	5	12	8011578906580
0253.200	TX 20	25	5	12	8011578906610
0253.250	TX 25	25	5	12	8011578906641
0253.270	TX 27	25	5	12	8011578906672
0253.300	TX 30	25	5	12	8011578906702

## 255 INSERTO TORX CON FORO 1/4" BIT TORX HEAD SCR. WITH HOLE 1/4"



Icona	Modello	Dimensione	Lunghezza	Materiali	Barcode
		T↔L↔			81157811000004
0255.060	TX 6	25	4	12	8011578933586
0255.070	TX 7	25	4	12	8011578933609
0255.080	TX 8	25	4	12	8011578932350
0255.090	TX 9	25	4	12	8011578932381
0255.100	TX 10	25	4	12	8011578932411
0255.150	TX 15	25	5	12	8011578932442
0255.200	TX 20	25	5	12	8011578932473
0255.250	TX 25	25	5	12	8011578932503
0255.270	TX 27	25	5	12	8011578932534
0255.300	TX 30	25	5	12	8011578932565
0255.400	TX 40	25	5	12	8011578938666

## 255Z INSERTO TORX CON FORO 1/4" BIT TORX HEAD SCR. WITH HOLE 1/4"



Icona	Modello	Dimensione	Lunghezza	Materiali	Barcode
		T↔L↔			81157811000004
0255.906	TX 6	50	8	12	8011578945848
0255.907	TX 7	50	8	12	8011578945862
0255.908	TX 8	50	8	12	8011578945886
0255.909	TX 9	50	8	12	8011578945909
0255.910	TX 10	50	8	12	8011578945923
0255.915	TX 15	50	8	12	8011578945947
0255.920	TX 20	50	8	12	8011578945961
0255.925	TX 25	50	10	12	8011578945985
0255.927	TX 27	50	10	12	8011578946005
0255.930	TX 30	50	12	12	8011578946029
0255.940	TX 40	50	12	12	8011578946043

## 256 INSERTO QUADRO 1/4" BIT-SQUARE 1/4"



Icona	Modello	Dimensione	Lunghezza	Materiali	Barcode
		T↔L↔			81157811000004
0256.100	SQ 1	25	4	12	8011578933623
0256.200	SQ 2	25	5	12	8011578933647
0256.300	SQ 3	25	5	12	8011578943660

## 258 INSERTO POZIDRIV 1/4" BIT POZIDRIV HEAD SCREWS 1/4"



DIN 3128 ISO 1173

Icona	Modello	Dimensione	Lunghezza	Materiali	Barcode
		T↔L↔			81157811000004
0258.100	PZ 1	50	11	12	8011578906733
0258.100-100	PZ 1	50	11	100	8011578960025
0258.200	PZ 2	50	11	12	8011578906764
0258.200-100	PZ 2	50	11	100	8011578960049
0258.300	PZ 3	50	11	12	8011578906795
0258.300-100	PZ 3	50	11	100	8011578960063
0258.400	PZ 4	50	12	12	8011578943844

## 258T INSERTO POZIDRIV 1/4" - titanium BIT POZIDRIV HEAD SCREWS 1/4" - titanium



DIN 3128 ISO 1173

Icona	Modello	Dimensione	Lunghezza	Materiali	Barcode
		T↔L↔			81157811000004
0258.910	PZ 1	50	11	12	8011578960902
0258.920	PZ 2	50	11	12	8011578960926

## 260 INSERTO CROCE PHILLIPS 1/4" BIT PHILLIPS CROSS HEAD SCR. 1/4"



DIN 3128 ISO 1173

Icona	Modello	Dimensione	Lunghezza	Materiali	Barcode
		T↔L↔			81157811000004
0260.100	PH 1	50	11	12	8011578906825
0260.100-100	PH 1	50	11	100	8011578960100
0260.200	PH 2	50	11	12	8011578906856
0260.200-100	PH 2	50	11	100	8011578960124
0260.300	PH 3	50	11	12	8011578906887
0260.300-100	PH 3	50	11	100	8011578960148
0260.400	PH 4	50	12	12	8011578946067

## 260T INSERTO CROCE PHILLIPS 1/4" - titanium BIT PHILLIPS CROSS HEAD SCR. 1/4" - titanium



DIN 3128 ISO 1173

Icona	Modello	Dimensione	Lunghezza	Materiali	Barcode
		T↔L↔			81157811000004
0260.910	PH 1	50	11	12	8011578960841
0260.920	PH 2	50	11	12	8011578960865

## 262 INSERTO PER VITI INTAGLIO 1/4" BIT FOR SLOTTED HEAD SCR. 1/4"



Icona	Modello	Dimensione	Lunghezza	Materiali	Barcode
		T↔L↔			81157811000004
0262.400	4	50	11	12	8011578906917
0262.400-100	4	50	11	100	8011578960186
0262.500	5	50	11	12	8011578906948
0262.500-100	5	50	11	100	8011578960209
0262.600	6	50	11	12	8011578906979
0262.600-100	6	50	11	100	8011578960223

**263** INSERTO VITI ESAGONO 1/4"  
 BIT HEXAGON HEAD SCREWS 1/4"

DIN 7426 

Model	Length (mm)	Width (mm)	Qty	PKG	Barcode	SKU
0263.015	1,5	25	4	12	8011578933685	
0263.020	2,0	25	4	12	8011578943585	
0263.025	2,5	25	4	12	8011578907006	
0263.030	3,0	25	4	12	8011578907037	
0263.040	4,0	25	5	12	8011578907099	
0263.050	5,0	25	5	12	8011578907129	
0263.060	6,0	25	6	12	8011578907150	

**263Z** INSERTO ESAGONO MASCHIO  
 HEXAGON MALE BIT

DIN 7426 

Model	Length (mm)	Width (mm)	Qty	PKG	Barcode	SKU
0263.930	3	50	8	12	8011578946081	
0263.940	4	50	10	12	8011578946104	
0263.950	5	50	12	12	8011578946128	
0263.960	6	50	12	12	8011578946142	

**1420** ADATTATORE 1/4" portainseriti univ. es. 1/4"  
 ADAPTER COUPLER 1/4" for bit hexagon 1/4"



Model	Qty	PKG	Barcode	SKU
1420.010	14	6	8011578929626	

**1470** ADATTATORE 3/8" portainseriti univ. es. 1/4"  
 ADAPTER COUPLER 3/8" for bit hexagon 1/4"



Model	Qty	PKG	Barcode	SKU
1470.010	24	6	8011578930370	

**1520** ADATTATORE 1/2" portainseriti universale esagono 1/4"  
 ADAPTER COUPLER 1/2" for bit hexagon 1/4"



Model	Qty	PKG	Barcode	SKU
1520.010	52	6	8011578949563	

**264** PORTAINSERITI CON IMPUGNATURA ATTACCO MAGNETICO 1/4" con 6 inserti  
 MAGNETIC BIT HOLDER WITH HANDLE 1/4" with 6 bits

Contenuto-content: 

Model	Length (mm)	Width (mm)	Qty	PKG	Barcode	SKU
0249.400	4 x 25	20250.100	PH 1 x 25	20251.100	PZ 1 x 25	
0249.500	5 x 25	20250.200	PH 2 x 25	20251.200	PZ 2 x 25	
0264.010	1/4"	150	105 x 30	158	2	8011578907181



**264A** PORTAINSERITI CON IMPUGNATURA ATTACCO MAGNETICO 1/4"  
 MAGNETIC BIT HOLDER WITH HANDLE 1/4"



Model	Length (mm)	Width (mm)	Qty	PKG	Barcode	SKU
0264.110	1/4"	150	105 x 30	120	6	8011578907211



**84** PORTAINSERITI MAGNETICO ATTACCO 1/4"  
 MAGNETIC BIT HOLDER 1/4"

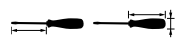

Model	Length (mm)	Width (mm)	Qty	PKG	Barcode	SKU
0084.010	1/4"	100	117 x 34	100	6	8011578952648



**87** PORTAINSERITI MAGNETICO FLESSIBILE ATTACCO 1/4"  
 FLEXIBLE MAGNETIC BIT HOLDER 1/4"









Model	Length (mm)	Width (mm)	Qty	PKG	Barcode	SKU
0087.010	1/4"	190	117 x 34	154	6	8011578952679
0087.310	con 6 bit	117 x 34	190	2	8011578960728	









**270** INSERTO ESAGONO MASCHIO mm. 10  
 HEXAGON MALE BIT mm. 10



					
					
<b>0270.040</b>	<b>4</b>	75	44	<b>6</b>	8011578946166
<b>0270.050</b>	<b>5</b>	75	44	<b>6</b>	8011578946180
<b>0270.060</b>	<b>6</b>	75	46	<b>6</b>	8011578946203
<b>0270.080</b>	<b>8</b>	75	48	<b>6</b>	8011578946227
<b>0270.100</b>	<b>10</b>	75	51	<b>6</b>	8011578946241







**274** INSERTO XZN mm. 10  
 XZN BIT mm. 10



					
					
<b>0274.005</b>	<b>XZN 5</b>	75	44	<b>6</b>	8011578946425
<b>0274.006</b>	<b>XZN 6</b>	75	46	<b>6</b>	8011578946449
<b>0274.008</b>	<b>XZN 8</b>	75	46	<b>6</b>	8011578946463
<b>0274.010</b>	<b>XZN 10</b>	75	48	<b>6</b>	8011578946487
<b>0274.012</b>	<b>XZN 12</b>	75	62	<b>6</b>	8011578946500







**272** INSERTO TORX mm. 10  
 TORX BIT mm. 10



					
					
<b>0272.020</b>	<b>TX 20</b>	75	44	<b>6</b>	8011578946265
<b>0272.025</b>	<b>TX 25</b>	75	44	<b>6</b>	8011578946289
<b>0272.027</b>	<b>TX 27</b>	75	42	<b>6</b>	8011578946302
<b>0272.030</b>	<b>TX 30</b>	75	44	<b>6</b>	8011578946326
<b>0272.040</b>	<b>TX 40</b>	75	46	<b>6</b>	8011578945664
<b>0272.045</b>	<b>TX 45</b>	75	46	<b>6</b>	8011578946364
<b>0272.050</b>	<b>TX 50</b>	75	48	<b>6</b>	8011578946388
<b>0272.055</b>	<b>TX 55</b>	75	50	<b>6</b>	8011578946401





**275** INSERTO RIBE mm. 10  
 RIBE BIT mm. 10



					
					
<b>0275.005</b>	<b>RIBE 5</b>	75	43	<b>6</b>	8011578946524
<b>0275.006</b>	<b>RIBE 6</b>	75	44	<b>6</b>	8011578946548
<b>0275.007</b>	<b>RIBE 7</b>	75	45	<b>6</b>	8011578946562
<b>0275.008</b>	<b>RIBE 8</b>	75	46	<b>6</b>	8011578946586
<b>0275.009</b>	<b>RIBE 9</b>	75	46	<b>6</b>	8011578946609
<b>0275.010</b>	<b>RIBE 10</b>	75	48	<b>6</b>	8011578946623
<b>0275.012</b>	<b>RIBE 12</b>	75	62	<b>6</b>	8011578946647

**276A** ADATTATORE PER INSERTI mm. 10  
 ADAPTER FOR BITS mm. 10



				
<b>0276.004</b>	F 3/8" - M 10 mm.28	28	<b>6</b>	8011578947088
<b>0276.006</b>	F 1/2" - M 10 mm.50	50	<b>6</b>	8011578947101



**276** CASSETTA 40 INSERTI ESAGONO-TORX-XZN 10 mm 3/8" - 1/2"  
 SET 40 BITS HEX-TORX-XZN 10 mm 3/8" - 1/2"

3/8" 1/2"   

Contenuto-content:

0276.004	0272.050	0272.020
0276.006	0272.055	0272.025
0270.040	0274.005	0272.030
0270.050	0274.006	0272.040
0270.060	0274.008	0272.045
0270.070	0274.010	0272.050
0270.080	0274.012	0272.055
0270.100	0270.040	0274.005
0270.120	0270.050	0274.006
0272.020	0270.060	0274.008
0272.025	0270.070	0274.010
0272.030	0270.080	0274.012
0272.040	0270.100	
0272.045	0270.120	



				
<b>0276.010</b>	330 x 130 x 40	1700	<b>1</b>	8011578947125





**278** CHIAVE A BUSSOLA ESAGONALE LAMA FLESSIBILE CON IMPUGNATURA  
 HEXAGONAL SOCKET WITH FLEXIBLE BLADE WITH HANDLE

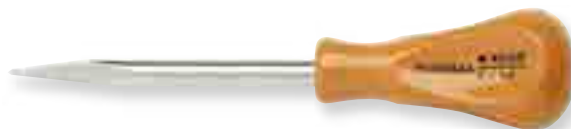

Model	Size	Length	Blade	Weight	Material	Code	Barcode
0278.050	5,0	170	105 x 30	153	6	8011578907365	
0278.055	5,5	170	105 x 30	126	6	8011578907396	
0278.060	6,0	170	105 x 30	154	6	8011578907426	
0278.070	7,0	170	105 x 30	150	6	8011578907457	
0278.080	8,0	170	105 x 30	150	6	8011578907488	
0278.090	9,0	170	105 x 30	153	6	8011578907518	
0278.100	10,0	170	105 x 30	154	6	8011578907549	
0278.110	11,0	170	105 x 30	135	6	8011578907570	
0278.120	12,0	170	105 x 30	135	6	8011578907600	
0278.130	13,0	170	105 x 30	141	6	8011578907631	

**303A** SPUNTONE - punta quadra - impugnatura acetato  
 PUNCH - square tip - acetate handle



Model	Size	Length	Blade	Weight	Material	Code	Barcode
0303.110	8 x 95	75 x 37	89	12		8011578907907	

**303B** SPUNTONE - punta tonda - impugnatura acetato  
 PUNCH - round tip - acetate handle



Model	Size	Length	Blade	Weight	Material	Code	Barcode
0303.210	8 x 95	75 x 37	90	12		8011578907938	

**304A** PUNTERUOLO - punta quadra - impugnatura acetato  
 PUNCH - square tip - acetate handle



Model	Size	Length	Blade	Weight	Material	Code	Barcode
0304.110	6 x 90	102 x 24	65	12		8011578907969	





**304B** PUNTERUOLO - punta tonda - impugnatura acetato  
 PUNCH - round tip - acetate handle





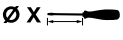

Model	Size	Length	Blade	Weight	Material	Code	Barcode
0304.210	6 x 90	102 x 24	62	12		8011578907990	





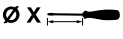

**305A** PUNTERUOLO - punta quadra - impugnatura acetato  
 PUNCH - square tip - acetate handle





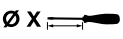

  
 0305.110 4 x 65 93 x 21 36 12 8011578908027





**305B** PUNTERUOLO - punta tonda - impugnatura acetato  
 PUNCH - round tip - acetate handle





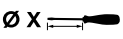

  
 0305.210 4 x 65 93 x 21 37 12 8011578908058







**307** LEVACHIODI PER LEVASEMENZE - impugnatura acetato  
 NAILS PULLER - acetate handle







  
 0307.010 6 x 70 102 x 24 66 12 8011578908089







**310** LEVACHIODI PER CALZOLAI - impugnatura acetato  
 NAILS PULLER FOR SHOEMAKERS - acetate handle







  
 0310.010 8 x 80 98 x 35 116 12 8011578908119

**311** LEVACHIODI PER TAPPEZZIERI - impugnatura acetato  
 NAILS PULLER FOR UPHOLSTERERS - acetate handle







  
 0311.010 95 98 x 35 139 12 8011578908140





**313** LEVAPUNTI - impugnatura acetato  
 PULLER - acetate handle





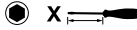

  
 0313.010 80 98 x 35 132 12 8011578908171

**316** CHIAVE A BUSSOLA CON IMPUGNATURA ACETATO - acciaio chrom-vanadium  
 SOCKET WITH ACETATE HANDLE - chrom-vanadium steel







DIN 3125

					
0316.040	4,0 x 80	102 x 24	48	6	8011578908201
0316.050	5,0 x 80	102 x 24	48	6	8011578908232
0316.055	5,5 x 80	102 x 24	48	6	8011578908263
0316.060	6,0 x 80	102 x 24	66	6	8011578908294
0316.070	7,0 x 80	102 x 24	111	6	8011578908324
0316.080	8,0 x 80	102 x 24	111	6	8011578908355
0316.090	9,0 x 80	102 x 24	111	6	8011578908386
0316.100	10,0 x 80	114 x 28	116	6	8011578908416
0316.110	11,0 x 80	114 x 28	122	6	8011578908447
0316.120	12,0 x 80	114 x 28	138	6	8011578908478
0316.130	13,0 x 80	114 x 28	143	6	8011578908508
0316.140	14,0 x 80	114 x 28	133	6	8011578908539

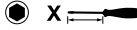

**318** CHIAVE A BUSSOLA CON IMPUGNATURA ACETATO - foro profondo - acciaio chrom-vanadium  
 SOCKET WITH ACETATE HANDLE - deep hole - chrom-vanadium steel







					
0318.050	5,0 x115	114 x 28	112	6	8011578947149
0318.055	5,5 x115	114 x 28	110	6	8011578947163
0318.060	6,0 x115	114 x 28	110	6	8011578943561
0318.070	7,0 x115	114 x 28	104	6	8011578908591
0318.080	8,0 x115	114 x 28	135	6	8011578908621
0318.090	9,0 x115	114 x 28	114	6	8011578908652
0318.100	10,0 x115	114 x 28	161	6	8011578908683
0318.110	11,0 x115	114 x 28	150	6	8011578943684
0318.120	12,0 x115	114 x 28	132	6	8011578947200
0318.130	13,0 x115	114 x 28	208	6	8011578908713
0318.140	14,0 x115	114 x 28	148	6	8011578947224

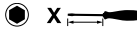

**82** CHIAVE A BUSSOLA ESAGONO FORO PROFONDO  
 DEEP HOLE HEXAGON SOCKET



					
0082.050	5,0 x 37	117 x 34	118	6	8011578952310
0082.055	5,5 x 37	117 x 34	118	6	8011578952341
0082.060	6,0 x 37	117 x 34	118	6	8011578952372
0082.070	7,0 x 72	117 x 34	136	6	8011578952402
0082.080	8,0 x 72	117 x 34	126	6	8011578952433
0082.090	9,0 x 72	117 x 34	128	6	8011578952464
0082.100	10,0 x 72	117 x 34	126	6	8011578952495
0082.110	11,0 x 72	117 x 34	158	6	8011578952525
0082.120	12,0 x 72	117 x 34	146	6	8011578952556
0082.130	13,0 x 72	117 x 34	152	6	8011578952587



**78**
**CHIAVE MASCHIO ESAGONALE SFERICA**  
 SPHERICAL HEXAGONAL MALE WRENCH

HRC 60

Icona	Ø X	Icona	Icona	Icona	Icona	Icona	Icona	Icona
0078.025	2,5 x 75	87,5 x 25,4	28	6	6	8011578952082		
0078.030	3,0 x 75	87,5 x 25,4	28	6	6	8011578952105		
0078.040	4,0 x 100	109 x 31,7	60	6	6	8011578952136		
0078.050	5,0 x 100	109 x 31,7	70	6	6	8011578952167		
0078.060	6,0 x 125	117 x 34,0	94	6	6	8011578952198		

**340**
**CHIAVE MASCHIO ESAGONALE CON IMPUGNATURA ACETATO - acciaio chrom-vanadium finitura brunita**  
 HEXAGONAL MALE WRENCH WITH ACETATE HANDLE - chrom-vanadium steel burnished finish

Icona	Ø X	Icona	Icona	Icona	Icona	Icona	Icona	Icona
0340.015	1,5 x 70	77 x 21	20	6	6	8011578943066		
0340.020	2,0 x 70	77 x 21	22	6	6	8011578908928		
0340.025	2,5 x 80	77 x 21	23	6	6	8011578908959		
0340.030	3,0 x 100	77 x 21	26	6	6	8011578908980		
0340.040	4,0 x 100	91 x 25	47	6	6	8011578909017		
0340.050	5,0 x 120	91 x 25	65	6	6	8011578909048		
0340.060	6,0 x 140	106 x 30	98	6	6	8011578909079		
0340.080	8,0 x 150	115 x 34	182	6	6	8011578909109		

**340A**
**SERIE 5 CHIAVI MASCHIO CON IMPUGNATURA ACETATO - cartone**  
 SET 5 MALE WRENCHES WITH ACETATE HANDLE - box

Contenuto-content:

- 0340.020 2
- 0340.030 3
- 0340.040 4
- 0340.050 5
- 0340.060 6

Icona	Icona	Icona	Icona	Icona	Icona	Icona	Icona	Icona
0340.110	310 x 180 x 37		418	6	6	8011578340193		

**341**
**CHIAVE MASCHIO QUADRATA CON IMPUGNATURA ACETATO - acciaio chrom-vanadium finitura cromata punta nera**  
 SQUARE MALE WRENCH WITH ACETATE HANDLE - chrom-vanadium steel chrome plated black finished tip

Icona	Icona	Icona	Icona	Icona	Icona	Icona	Icona	Icona
0341.100	SQ 1-4 x 100	91 x 25	61	12	6	8011578909161		
0341.200	SQ 2-5 x 125	106 x 30	89	12	6	8011578909192		
0341.300	SQ 3-6 x 150	106 x 30	98	12	6	8011578909222		

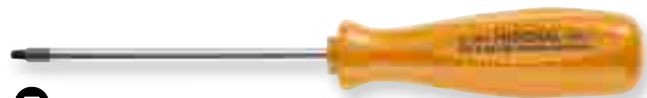
**75**
**GIRAVITE PER VITI TORX CON FORO**  
 SCREWDRIVER FOR TORX WITH HOLE HEAD SCREWS

HRC 60

Icona	Icona	Icona	Icona	Icona	Icona	Icona	Icona	Icona
0075.060	TX 6 x 60	87,5 x 25,4	28	6	6	8011578951740		
0075.070	TX 7 x 60	87,5 x 25,4	28	6	6	8011578951771		
0075.080	TX 8 x 60	87,5 x 25,4	30	6	6	8011578951801		
0075.090	TX 9 x 60	109 x 31,7	56	6	6	8011578951832		
0075.100	TX 10 x 80	109 x 31,7	58	6	6	8011578951863		
0075.150	TX 15 x 80	109 x 31,7	60	6	6	8011578951894		
0075.200	TX 20 x 100	109 x 31,7	62	6	6	8011578951924		
0075.250	TX 25 x 100	109 x 31,7	70	6	6	8011578951955		
0075.270	TX 27 x 100	109 x 31,7	66	6	6	8011578951986		
0075.300	TX 30 x 100	117 x 34,0	88	6	6	8011578952013		
0075.400	TX 40 x 125	127 x 36,9	138	6	6	8011578952044		
0075.450	TX 45 x 125	127 x 36,9	138	6	6	8011578952075		



**343** CHIAVE PER VITI TORX CON IMPUGNATURA ACETATO - acciaio chrom-vanadium finitura cromata punta nera  
WRENCH FOR TORX-HEAD SCREWS WITH ACETATE HANDLE - chrom-vanadium steel chrome plated black finished tip

Model	Size	Length	Width	Weight	Material	Barcode
0343.060	TX 6 x 70	77 x 21	24	6	8011578909550	811578909550
0343.070	TX 7 x 70	77 x 21	24	6	8011578909581	811578909581
0343.080	TX 8 x 80	77 x 21	22	6	8011578909611	811578909611
0343.090	TX 9 x 80	77 x 21	27	6	8011578909642	811578909642
0343.100	TX 10 x 80	77 x 21	28	6	8011578909673	811578909673
0343.150	TX 15 x 100	91 x 25	46	6	8011578909703	811578909703
0343.200	TX 20 x 100	91 x 25	48	6	8011578909734	811578909734
0343.250	TX 25 x 100	91 x 25	56	6	8011578909765	811578909765
0343.270	TX 27 x 120	106 x 30	84	6	8011578909796	811578909796
0343.300	TX 30 x 120	106 x 30	96	6	8011578909826	811578909826
0343.400	TX 40 x 140	115 x 34	150	6	8011578909857	811578909857
0343.450	TX 45 x 140	115 x 34	151	6	8011578909888	811578909888

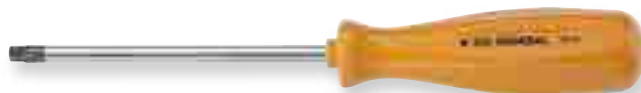

**343D** SERIE 5 CHIAVI TORX CON IMPUGNATURA ACETATO - cartone  
SET 5 TORX WRENCHES WITH ACETATE HANDLE - box

Contenuto-content:

0343.100	TX 10 x 80	0343.250	TX 25 x 100
0343.150	TX 15 x 100	0343.300	TX 30 x 120
0343.200	TX 20 x 100		

Model	Dimensions	Weight	Barcode
0343.490	310 x 180 x 37	423	8011578343279



**343H** CHIAVE PER VITI TORX CON FORO CON IMPUGNATURA ACETATO - acc. chrom-vanadium fin. cromata punta nera  
WRENCH TORX HEAD SCREWS WITH HOLE WITH ACETATE HANDLE - chrom-vanadium steel chrome plated black fin. tip

Model	Size	Length	Width	Weight	Material	Barcode
0343.605	TX 5 x 60	77 x 21	24	6	8011578933708	811578933708
0343.606	TX 6 x 60	77 x 21	26	6	8011578933722	811578933722
0343.607	TX 7 x 60	77 x 21	24	6	8011578933746	811578933746
0343.608	TX 8 x 60	77 x 21	24	6	8011578933760	811578933760
0343.609	TX 9 x 60	77 x 21	23	6	8011578909970	811578909970
0343.610	TX 10 x 80	77 x 21	29	6	8011578910006	811578910006
0343.615	TX 15 x 80	91 x 25	46	6	8011578910037	811578910037
0343.620	TX 20 x 100	91 x 25	48	6	8011578910068	811578910068
0343.625	TX 25 x 100	91 x 25	56	6	8011578910099	811578910099
0343.627	TX 27 x 115	106 x 30	83	6	8011578910129	811578910129
0343.630	TX 30 x 115	106 x 30	96	6	8011578910150	811578910150
0343.640	TX 40 x 130	115 x 34	152	6	8011578910181	811578910181

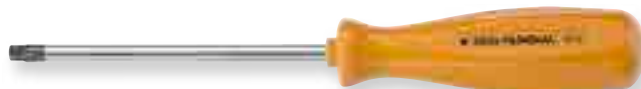

**343HT** SERIE 5 CHIAVI TORX CON FORO CON IMPUGNATURA ACETATO - cartone  
SET 5 WRENCHES FOR TORX HEAD SCREWS WITH HOLE WITH ACETATE HANDLE - box

Contenuto-content:

0343.610	TX 10	0343.625	TX 25
0343.615	TX 15	0343.630	TX 30
0343.620	TX 20		

Model	Dimensions	Weight	Barcode
0343.690	310 x 180 x 37	425	8011578343774



**343TT** ESPOSITORE 57 CHIAVI TORX - con foro  
DISPLAY STAND 57 TORX WRENCHES - with hole

Contenuto-content:

0343.606	TX 6	Nr. 5	0343.620	TX 20	Nr. 5
0343.607	TX 7	Nr. 5	0343.625	TX 25	Nr. 5
0343.608	TX 8	Nr. 5	0343.627	TX 27	Nr. 5
0343.609	TX 9	Nr. 5	0343.630	TX 30	Nr. 4
0343.610	TX 10	Nr. 5	0343.640	TX 40	Nr. 4
0343.615	TX 15	Nr. 5	0343.450	TX 45	Nr. 4

Model	Dimensions	Weight	Barcode
0343.710	410 x 230 x 200	10200	8011578343798



**344** CHIAVE MASCHIO ESAGONALE CON IMPUGNATURA A "T" BICOMPONENTE - acciaio chrom-vanadium finitura cromata  
 HEXAGONAL MALE WRENCH WITH "T" BICOMPONENT HANDLE - chrom-vanadium steel chrome plated finish



Model	Size	Length	Width	Weight	Material	Barcode
0344.020	2,0 x 100	140 x	65	14	6	8011578910242
0344.025	2,5 x 100	140 x	65	14	6	8011578910273
0344.030	3,0 x 100	145 x	65	22	6	8011578910303
0344.040	4,0 x 150	210 x	90	57	6	8011578910365
0344.050	5,0 x 150	210 x	90	72	6	8011578910426
0344.060	6,0 x 150	210 x	90	88	6	8011578910457
0344.080	8,0 x 160	230 x	115	178	6	8011578910518
0344.100	10,0 x 180	260 x	120	268	6	8011578910570

**344A** SERIE 7 CHIAVI ESAGONO A "T"  
 SET 7 HEXAGON WRENCHES "T" HANDLE

Contenuto-content:

0344.020	2	0344.050	5
0344.025	2,5	0344.060	6
0344.030	3	0344.080	8
0344.040	4		

Model	Dimensions	Weight	Barcode
0344.110	370 x 210 x 40	660	8011578960742



**344X** CHIAVE MASCHIO TORX CON IMPUGNATURA A "T" - con foro  
 TORX WRENCH WITH "T" HANDLE - with hole

Model	Size	Length	Width	Weight	Material	Barcode
0344.206	TX 6 x 100	140 x	65	22	6	8011578933784
0344.207	TX 7 x 100	140 x	65	22	6	8011578933807
0344.208	TX 8 x 100	140 x	65	22	6	8011578933821
0344.209	TX 9 x 100	140 x	65	22	6	8011578933845
0344.210	TX 10 x 100	140 x	65	22	6	8011578933869
0344.215	TX 15 x 100	140 x	65	27	6	8011578933883
0344.220	TX 20 x 100	160 x	90	50	6	8011578933906
0344.225	TX 25 x 150	210 x	95	61	6	8011578933920
0344.227	TX 27 x 150	210 x	95	69	6	8011578933944
0344.230	TX 30 x 150	210 x	95	77	6	8011578933968
0344.240	TX 40 x 200	260 x	95	120	6	8011578933982



**344XT** SERIE 7 CHIAVI TORX A "T"  
 SET 7 TORX WRENCHES "T" HANDLE

Contenuto-content:

0344.206	TX 6	0344.220	TX 20
0344.208	TX 8	0344.225	TX 25
0344.210	TX 10	0344.230	TX 30
0344.215	TX 15		

Model	Dimensions	Weight	Barcode
0344.280	370 x 210 x 40	490	8011578344580













## 344F

**CHIAVE TRE ESTREMITÀ ASTA SCORREVOLE MASCHIO ESAGONALI - acc. chrom-vanadium fin. cromata punte nere**  
**HEXAGONAL MALE THREE ENDS WRENCH SLIDING BAR - chrom-vanadium steel chrome plated black finished tips**



scorrevole  
sliding



Icona	Dimensione	Lunghezza	Quantità	Articolo	Barcode
	2,0	65 x 130	22	6	8011578910600
	2,5	65 x 130	22	6	8011578910631
	3,0	65 x 150	22	6	8011578910662
	4,0	90 x 180	64	6	8011578910723
	5,0	90 x 180	66	6	8011578910785
	6,0	105 x 215	134	6	8011578910815
	8,0	125 x 250	224	2	8011578910877
	10,0	145 x 300	382	2	8011578910938
	12,0	165 x 315	575	2	8011578910969
	14,0	170 x 340	822	2	8011578910990

## 344FZ

**SERIE 6 CHIAVI ESAGONO TRE TESTE - cartone**  
**SET 6 HEXAGON THREE HEADS WRENCHES - box**

Contenuto - content:

0344.320	mm 2	0344.350	mm 5
0344.325	mm 2,5	0344.360	mm 6
0344.330	mm 3		
0344.340	mm 4		

Icona	Dimensione	Lunghezza	Quantità	Articolo	Barcode
	370 x 210 x 40		546		8011578344924



## 344FT

**SERIE 10 CHIAVI ESAGONO TRE TESTE**  
**SET 10 T HEXAGON THREE HEADS WRENCHES**

Contenuto - content:













0344.320	mm 2	0344.360	mm 6
0344.325	mm 2,5	0344.380	mm 8
0344.330	mm 3	0344.391	mm 10
0344.340	mm 4	0344.392	mm 12
0344.350	mm 5	0344.394	mm 14

Icona	Dimensione	Lunghezza	Quantità	Articolo	Barcode
	370 x 210 x 40		2334		8011578344948



## 344T

**CHIAVE TRE TESTE TORX ASTA SCORREVOLE**  
**TORX THREE HEADS WRENCH SLIDING BAR**

Icona	Dimensione	Lunghezza	Quantità	Articolo	Barcode
	TX 6	65 x 125	22	6	8011578943226
	TX 7	65 x 125	22	6	8011578943240
	TX 8	65 x 125	22	6	8011578943264
	TX 9	65 x 125	23	6	8011578943288
	TX 10	65 x 125	23	6	8011578943301
	TX 15	65 x 125	23	6	8011578943325
	TX 20	65 x 125	23	6	8011578943349
	TX 25	90 x 180	66	6	8011578943363
	TX 27	90 x 180	66	2	8011578943387
	TX 30	90 x 180	66	2	8011578943400
	TX 40	105 x 210	138	2	8011578943424
	TX 45	105 x 210	138	2	8011578943448



## 344TZ

**SERIE 6 CHIAVI TRE TESTE TORX - cartone**  
**SET 6 TORX THREE HEADS WRENCHES - box**

Contenuto-content:

- 0344.408 TX 8
- 0344.410 TX 10
- 0344.415 TX 15
- 0344.420 TX 20
- 0344.425 TX 25
- 0344.430 TX 30

 **0344.480** 310 x 180 x 37

 435

 80115781100004



## 344TX

**SERIE 12 CHIAVI TRE TESTE TORX**  
**SET 12 TORX THREE HEADS WRENCHES**

Contenuto-content:

- 0344.406 TX 6
- 0344.407 TX 7
- 0344.408 TX 8
- 0344.409 TX 9
- 0344.410 TX 10
- 0344.415 TX 15
- 0344.420 TX 20
- 0344.425 TX 25
- 0344.427 TX 27
- 0344.430 TX 30
- 0344.440 TX 40
- 0344.445 TX 45

 **0344.490**

 620







 80115781100004



## 345

**CHIAVE MASCHIO ESAGONALE - professionale - acciaio chrom-vanadium finitura nichelata**  
**HEXAGONAL MALE WRENCH - professional - chrom-vanadium steel nickel plated finish**

DIN ISO 2936

					
0345.015	1,5	45 x 14	2	12	8011578911027
0345.020	2,0	50 x 16	3	12	8011578911058
0345.025	2,5	56 x 18	4	12	8011578911089
0345.030	3,0	63 x 20	5	12	8011578911119
0345.035	3,5	66 x 22	7	12	8011578911140
0345.040	4,0	70 x 25	10	12	8011578911171
0345.050	5,0	80 x 28	18	12	8011578911232
0345.060	6,0	90 x 32	30	12	8011578911294
0345.070	7,0	95 x 34	42	12	8011578911324
0345.080	8,0	100 x 36	61	12	8011578911355
0345.100	10,0	112 x 40	106	12	8011578911416
0345.120	12,0	125 x 45	172	12	8011578911447
0345.140	14,0	140 x 56	264	6	8011578911508
0345.170	17,0	160 x 63	443	6	8011578911539
0345.190	19,0	180 x 70	600	6	8011578911560
0345.220	22,0	230 x 110	932	2	8011578934026
0345.240	24,0	235 x 110	1193	2	8011578934040



## 346

**SERIE 7 CHIAVI MASCHIO ESAGONALE - clip in plastica**  
**SET 7 HEXAGONAL MALE WRENCHES - plastic clip**

Contenuto-content:

- 0345.015 1,5
- 0345.020 2
- 0345.025 2,5
- 0345.030 3
- 0345.040 4
- 0345.050 5
- 0345.060 6

 **0346.070**

 94

 **6**  80115781100004



**347** SERIE 9 CHIAVI MASCHIO ESAGONALE - clip in plastica  
 SET 9 HEXAGONAL MALE WRENCHES - plastic clip







Contenuto-content:

0345.015	1,5	0345.030	3	0345.060	6
0345.020	2	0345.040	4	0345.080	8
0345.025	2,5	0345.050	5	0345.100	10

			
<b>0347.090</b>	291	<b>6</b>	8011578347000



**350** CHIAVE MASCHIO ESAGONALE LUNGA ESTREMITÀ SFERICA - acciaio chrom-vanadium  
 LONG SPHERICAL END HEXAGONAL MALE WRENCH - chrom-vanadium steel

					
<b>0350.015</b>	<b>1,5</b>	80 x 16	2	<b>6</b>	8011578934064
<b>0350.020</b>	<b>2,0</b>	83 x 16	3	<b>6</b>	8011578911652
<b>0350.025</b>	<b>2,5</b>	93 x 20	5	<b>6</b>	8011578911683
<b>0350.030</b>	<b>3,0</b>	98 x 20	8	<b>6</b>	8011578911713
<b>0350.040</b>	<b>4,0</b>	110 x 30	12	<b>6</b>	8011578911744
<b>0350.050</b>	<b>5,0</b>	123 x 38	25	<b>6</b>	8011578911775
<b>0350.060</b>	<b>6,0</b>	140 x 38	41	<b>6</b>	8011578911805
<b>0350.080</b>	<b>8,0</b>	156 x 36	85	<b>6</b>	8011578911867
<b>0350.100</b>	<b>10,0</b>	170 x 40	142	<b>6</b>	8011578911898



**351** SERIE 9 CHIAVI ESAGONALI LUNGHE ESTREMITÀ SFERICA - clip in plastica  
 SET 9 LONG SPHERICAL END HEXAGONAL WRENCHES - plastic clip

Contenuto-content:

0350.015	1,5	0350.030	3	0350.060	6
0350.020	2	0350.040	4	0350.080	8
0350.025	2,5	0350.050	5	0350.100	10

			
<b>0351.090</b>	380	<b>6</b>	8011578351007



**352** SERIE 9 CHIAVI ESAGONALI LUNGHE ESTREMITÀ SFERICA - clip in plastica - EXTRA LUNGA  
 SET 9 EXTRA LONG SPHERICAL END HEXAGONAL WRENCHES - plastic clip - EXTRA LONG







Contenuto-content:

0352.010	1,5	0352.030	3	0352.060	6
0352.020	2	0352.040	4	0352.080	8
0352.025	2,5	0352.050	5	0352.100	10

			
<b>0352.090</b>	410	<b>6</b>	8011578947422



**355** CHIAVE MASCHIO ESAGONALE ESTREMITÀ TRONCATE - acciaio chrom-vanadium finitura nichelata  
 CUT END HEXAGONAL MALE WRENCH - chrom-vanadium steel nickel plated finish

					
<b>0355.015</b>	<b>1,5</b>	52 x 15	3	<b>12</b>	8011578911942
<b>0355.020</b>	<b>2,0</b>	53 x 19	3	<b>12</b>	8011578911959
<b>0355.025</b>	<b>2,5</b>	53 x 19	4	<b>12</b>	8011578911980
<b>0355.030</b>	<b>3,0</b>	73 x 23	5	<b>12</b>	8011578912017
<b>0355.035</b>	<b>3,5</b>	76 x 29	8	<b>12</b>	8011578912048
<b>0355.040</b>	<b>4,0</b>	80 x 29	11	<b>12</b>	8011578912079
<b>0355.045</b>	<b>4,5</b>	83 x 32	14	<b>12</b>	8011578912109
<b>0355.050</b>	<b>5,0</b>	84 x 32	18	<b>12</b>	8011578912130
<b>0355.055</b>	<b>5,5</b>	90 x 32	24	<b>12</b>	8011578912161
<b>0355.060</b>	<b>6,0</b>	102 x 36	23	<b>12</b>	8011578912192
<b>0355.070</b>	<b>7,0</b>	98 x 40	41	<b>12</b>	8011578912222
<b>0355.080</b>	<b>8,0</b>	106 x 42	60	<b>12</b>	8011578912253
<b>0355.090</b>	<b>9,0</b>	110 x 42	78	<b>12</b>	8011578912284
<b>0355.100</b>	<b>10,0</b>	122 x 50	103	<b>12</b>	8011578912314

DIN 911





## 356 SERIE 6 CHIAVI ESAGONO SET 6 HEXAGON WRENCHES

Contenuto-content: (2 - 2,5 - 3 - 4 - 5 - 6)

 **0356.010**
 **189**
 **6**
 8011578112345







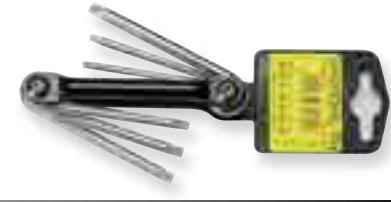

## 357 SERIE 6 CHIAVI TORX SET 6 TORX WRENCHES

Contenuto-content: (TX 10 - 15 - 20 - 25 - 27 - 30)

 **0357.015**
 **92**
 **6**
 8011578357016



## 360 CHIAVE PER VITI TORX - acciaio chrom-vanadium WRENCH FOR TORX HEAD SCREWS - chrom-vanadium steel

					
<b>0360.060</b>	<b>TX 6</b>	42 x 16	<b>2</b>	<b>6</b>	8011578912406
<b>0360.070</b>	<b>TX 7</b>	48 x 16	<b>3</b>	<b>6</b>	8011578912437
<b>0360.080</b>	<b>TX 8</b>	48 x 16	<b>3</b>	<b>6</b>	8011578912468
<b>0360.090</b>	<b>TX 9</b>	48 x 16	<b>3</b>	<b>6</b>	8011578912499
<b>0360.100</b>	<b>TX 10</b>	51 x 17	<b>4</b>	<b>6</b>	8011578912529
<b>0360.150</b>	<b>TX 15</b>	54 x 18	<b>5</b>	<b>6</b>	8011578912550
<b>0360.200</b>	<b>TX 20</b>	62 x 19	<b>7</b>	<b>6</b>	8011578912581
<b>0360.250</b>	<b>TX 25</b>	60 x 20	<b>10</b>	<b>6</b>	8011578912611
<b>0360.270</b>	<b>TX 27</b>	64 x 21	<b>13</b>	<b>6</b>	8011578912642
<b>0360.300</b>	<b>TX 30</b>	70 x 24	<b>20</b>	<b>6</b>	8011578912673
<b>0360.400</b>	<b>TX 40</b>	76 x 26	<b>30</b>	<b>6</b>	8011578912703
<b>0360.450</b>	<b>TX 45</b>	82 x 28	<b>43</b>	<b>6</b>	8011578912734
<b>0360.500</b>	<b>TX 50</b>	105 x 42	<b>64</b>	<b>6</b>	8011578934088



## 362 SERIE 9 CHIAVI TORX - clip in plastica SET 9 TORX WRENCHES - plastic clip

Contenuto-content:

0360.100 10  
 0360.150 15  
 0360.200 20  
 0360.250 25  
 0360.270 27  
 0360.300 30  
 0360.400 40  
 0360.450 45  
 0360.500 50

 **0362.090**
 **284**
 **6**
 8011578362010



## 366 SERIE 9 CHIAVI TORX CON FORO LUNGHE - clip in plastica SET 9 LONG TORX WRENCHES WITH HOLE - plastic clip

Contenuto-content:

0361.100 10  
 0361.150 15  
 0361.200 20  
 0361.250 25  
 0361.270 27  
 0361.300 30  
 0361.400 40  
 0361.450 45  
 0361.500 50

 **0366.090**
 **346**
 **6**
 8011578366018



**370** MAZZUOLA TESTE IN POLIURETANO - manico legno  
 Mallet with polyurethane head - wooden handle

UNI 7784

Icona	Ø	L	Peso	Icona	Barcode
					011578    000004
0370.022	22	250	168	4	8011578912826
0370.028	28	280	263	4	8011578912857
0370.035	35	310	408	4	8011578912888
0370.042	42	320	610	4	8011578912918
0370.050	50	360	954	2	8011578912949
0370.060	60	380	1402	2	8011578912970



**371** RICAMBI PER MAZZUOLA - poliuretano  
 Spare for mallet - polyurethane

Icona	Ø	Peso	Icona	Barcode
				011578    000004
0371.022	22	12	6	8011578913007
0371.028	28	34	6	8011578913038
0371.035	35	60	6	8011578913069
0371.042	42	90	6	8011578913090
0371.050	50	124	6	8011578913120
0371.060	60	200	6	8011578913151

alla coppia - in couple



**372** MAZZUOLA GOMMA NERA - manico legno antisfilamento  
 Black rubber mallet - wooden handle no-unthreading

DIN 5128

Icona	Gr.	Ø	L	Peso	Icona	Barcode
						011578    000004
0372.030	300	50	320	382	4	8011578913182
0372.050	500	60	340	570	4	8011578913212
0372.080	800	70	380	862	2	8011578913243



**373** MAZZUOLA GOMMA BIANCA - manico legno antisfilamento  
 White rubber mallet - wooden handle no-unthreading

DIN 5128

Icona	Gr.	Ø	L	Peso	Icona	Barcode
						011578    000004
0373.030	300	50	320	426	4	8011578913274
0373.050	500	60	345	622	4	8011578938628
0373.080	800	70	350	814	2	8011578938642



**373Z** MAZZUOLA RAME - manico legno  
 Copper mallet - wooden handle

Icona	Gr.	Peso	Icona	Barcode	Stato
				011578    000004	
0373.905	500	580	2	8011578965921	new
0373.908	800	900	2	8011578965945	new
0373.910	1000	1150	2	8011578965969	new
0373.915	1500	1600	2	8011578965983	new



### 374 MAZZUOLA ANTIRIMBALZO NO REBOUND Mallet



Gr.	Ø	←L→	📦	📦	📦	📦
0374.050	500	44	300	504	4	8011578943981
0374.060	600	49	310	650	4	8011578944001
0374.080	800	50	340	866	2	8011578944025
0374.100	1000	60	380	1120	2	8011578944049

### 375 MAZZUOLA ANTIRIMBALZO - manico legno NO REBOUND Mallet - wooden handle



Ø	←L→	📦	📦	📦	📦	
0375.030	30	100 x 350	354	4	8011578963521	new
0375.035	35	120 x 370	534	4	8011578963545	new
0375.040	40	125 x 375	632	4	8011578963569	new
0375.050	50	145 x 380	978	2	8011578963583	new
0375.060	60	150 x 450	1750	2	8011578963606	new

### 376 MAZZUOLA ANTIRIMBALZO - manico acciaio NO REBOUND Mallet - steel handle



Ø	←L→	📦	📦	📦	📦	
0376.035	35	122 x 295	610	4	8011578963620	new
0376.040	40	125 x 305	710	4	8011578963644	new
0376.050	50	145 x 365	1120	2	8011578963668	new
0376.060	60	150 x 375	1732	2	8011578963682	new

### 376 RICAMBI PER MAZZUOLE per art. 375-376 - poliuretano SPARE FOR MALLETS for art. 375-376 - polyurethane





Ø	📦	📦	📦	📦
0376.130	30	30	6	8011578963705
0376.135	35	48	6	8011578963729
0376.140	40	70	6	8011578963743
0376.150	50	132	6	8011578963767
0376.160	60	172	6	8011578963781

alla coppia - in couple



**377** **MARTELLI PER MECCANICI - acciaio al carbonio - finitura verniciata - manico legno**  
**HAMMER FOR MECHANIC - carbon steel - varnished finish - wooden handle**

DIN 1041

Icona	Gr.	H-L	Icona	Icona	Barcode
					011578    000004
0377.010	100	260	170	6	8011578913366
0377.020	200	280	254	6	8011578913397
0377.030	300	300	377	6	8011578913427
0377.040	400	310	504	6	8011578913458
0377.050	500	320	588	6	8011578913489
0377.060	600	330	682	6	8011578913519
0377.080	800	350	996	4	8011578913540
0377.100	1000	350	1118	4	8011578913571
0377.150	1500	380	1600	2	8011578913601
0377.200	2000	400	2100	2	8011578913663



**378** **MANICO PER MARTELLI**  
**HANDLE FOR HAMMER**

Icona	Gr.	H-L	Icona	Barcode
				011578    000004
0378.010	100	260	40	8011578913694
0378.020	200	280	62	8011578913724
0378.030	300	300	73	8011578913755
0378.040	400	310	78	8011578913786
0378.050	500	320	125	8011578913816
0378.060	600	330	123	8011578913847
0378.080	800	350	142	8011578913878
0378.100	1000	360	162	8011578913908
0378.150	1500	375	168	8011578942083
0378.200	2000	400	194	8011578942106





**380** **MARTELLI PER MECCANICI - acciaio carbonio finitura verniciata - manico sintetico antivibrazione**  
**HAMMER FOR MECHANIC - carbon steel varnished finish - synthetic handle no-vibration**





**GOMMOGRIP**  
**MUNDIAL**

**Impugnatura morbida bicomponente.**  
 Soft bicomponent handle.

Icona	Gr.	H-L	Icona	Icona	Barcode
					011578    000004
0380.020	200	290	307	6	8011578913939
0380.030	300	300	466	6	8011578913960
0380.050	500	320	718	6	8011578914028
0380.080	800	320	1008	6	8011578942649
0380.100	1000	320	1186	6	8011578942663





**381** **MARTELLI PER FALEGNAMI - manico legno**  
**HAMMER FOR CARPENTER - wooden handle**



Icona	Gr.	H-L	Icona	Icona	Barcode
					011578    000004
0381.030	300	300	365	6	8011578914059





**381C** MARTELO AMERICANO - manico legno  
 CLAW HAMMER - wooden handle



	Gr.				
0381.340	400	320	616	6	8011578914080





**382** MARTELO PER CARPENTIERI - manico legno  
 HAMMER FOR CARPENTERS - wooden handle



	Gr.				
0382.030	300	440	530	6	8011578914110
0382.040	400	440	585	6	8011578914141





**382B** MANICO  
 HANDLE



	Gr.			
0382.210	300/400	440	175	8011578914233





**382Z** MARTELO CARPENTIERI MANICO FIBRA CON CALAMITA  
 SYNTHETIC HANDLE HAMMER WITH MAGNET



	Gr.				
0382.925	250	500	653	4	8011578934248
0382.930	300	500	683	4	8011578934262
0382.940	400	500	766	4	8011578934286





**383** MAZZETTA PER MURATORE - manico legno  
 HAMMER FOR MASON - wooden handle



	Gr.				
0383.080	800	260	954	2	8011578914264
0383.100	1000	260	1128	2	8011578914271

**383Z** MAZZETTA MURATORE MANICO FIBRA ANTIFILAMENTO  
 MALLET FOR MASON SYNTHETIC SELF LOOKING HANDLE



	Gr.				
0383.908	800	265	1034	2	8011578934309
0383.910	1000	280	1198	2	8011578934323
0383.912	1250	280	1420	2	8011578934347



**384** MARTELLO MURATORE - manico legno  
 HAMMER FOR MASON - wooden handle



Gr. 400  
 0384.040 500 2 8011578970383

new

**385** MARTELLINA MALAPEGGIO - manico legno  
 HAMMER FOR MASON - wooden handle



Gr. 400  
 0385.040 500 2 8011578966027

new

**385B** MARTELLO CALDERAIO - manico legno  
 BALL PEIN HAMMER - wooden handle



Gr. 300  
 0385.903 380 2 8011578966041  
 0385.905 500 2 8011578966065  
 0385.908 800 2 8011578966089  
 0385.910 1000 2 8011578966102

new

new

new





new

**386** MARTELLO PER OROLOGIAIO - finitura cromata - manico legno  
 HAMMER FOR WATCHMAKERS - chrome plated fin. - wooden handle







Gr. 35  
 0386.010 230 52 6 8011578914295





**387** MARTELO PER TAPPEZZIERE CON PENNA LEVACHIODO - finitura cromata - manico legno  
 HAMMER FOR UPHOLSTERER-NAIL PULLER - chrome plated finish - wooden handle

	Gr.				
<b>0387.010</b>	<b>85</b>	310	216	<b>6</b>	8011578914325





**387C** MARTELO PER TAPPEZZIERE CON PENNA LEVACHIODO - CALAMITATO - manico legno  
 HAMMER FOR UPHOLSTERER-NAIL PULLER - WITH MAGNET - wooden handle

	Gr.				
<b>0387.310</b>	<b>85</b>	310	202	<b>6</b>	8011578914356





**388** MARTELO PER TAPPEZZIERE CON PENNA PIANA - finitura cromata - manico legno  
 HAMMER FOR UPHOLSTERER-FLAT - chrome plated finish - wooden handle

	Gr.				
<b>0388.010</b>	<b>150</b>	350	170	<b>6</b>	8011578914387

**388A** MANICO  
 HANDLE

	Gr.			
<b>0388.110</b>	<b>350</b>	350	50	8011578914417

**388C** MARTELO PER TAPPEZZIERI CON PENNA PIANA - CALAMITATO - manico legno  
 HAMMER FOR UPHOLSTERER-FLAT - MAGNETIC - wooden handle

	Gr.				
<b>0388.310</b>	<b>150</b>	350	186	<b>6</b>	8011578914448

**390** ESPOSITORE 18 MARTELLI  
 DISPLAY STAND 18 HAMMERS

Contenuto-content:

0380.020	200	Nr. 2	0382.930	300	Nr. 2
0380.030	300	Nr. 2	0383.908	800	Nr. 2
0380.050	500	Nr. 2	0383.910	1000	Nr. 2
0380.080	800	Nr. 1	0383.912	1250	Nr. 2
0380.100	1000	Nr. 1			
0382.925	250	Nr. 2			

			
<b>0390.010</b>	500 x 500 x 400	19100	8011578947446
<b>0390.210</b>	vuoto - empty	3300	8011578948740



**402** TAGLIABULLONI - acciaio speciale alta resistenza al taglio - finitura verniciata - impugnatura isolata  
 BOLT CUTTERS - special steel high cut resistant - varnished finish - insulated handle



Model	Length	Opening	Head Size	Weight	Material	Barcode
0402.035	350	5	60 x 7	897	1	8011578960582
0402.045	450	6	69 x 8	1560	1	8011578960605
0402.060	600	8	84 x 9,6	2650	1	8011578960629
0402.075	750	10	96 x 11	3900	1	8011578960643
0402.090	900	12	108 x 13	5650	1	8011578960667

**403** LAME RICAMBIO TAGLIABULLONI - acciaio speciale alta resistenza al taglio  
 SPARE HEADS FOR BOLT CUTTERS - special steel-high cut resistant

Model	Length	Opening	Head Size	Weight	Material	Barcode
0403.035	350	5	60 x 7	344	1	8011578914622
0403.045	450	6	69 x 8	530	1	8011578914653
0403.060	600	8	84 x 9,6	910	1	8011578914684
0403.075	750	10	96 x 11	1310	1	8011578914714
0403.090	900	12	108 x 13	1960	1	8011578914745



**404** MINI TAGLIABULLONI - acciaio speciale alta resistenza al taglio - finitura verniciata - impugnatura plasticata  
 BOLT CUTTERS-SMALL - special steel high cut resistant - varnished finish - plastic handle



Model	Length	Opening	Head Size	Weight	Material	Barcode
0404.020	200	4	38 x 4,5	304	6	8011578914776

**404.900** ESPOSITORE IN CARTONE 18 MINI TAGLIABULLONI  
 CARTON DESK DISPLAY 18 MINI BOLT CUTTERS



Contenuto-content:  
 0404.020 Nr. 18

Model	Dimensions	Weight	Barcode
0404.900	260 x 260 x 260	6300	8011578947460

**405** TRONCHESE TAGLIAFUNI PER FUNI ACCIAIO  
 WIRE ROPE CUTTER



Model	Length	Opening	Weight	Material	Barcode
0405.030	600	12	2500	1	8011578960681
0405.035	900	14	5600	1	8011578960704

**407** TRONCHESE TAGLIACAVI PER FUNI ACCIAIO  
 WIRE ROPE CUTTER



Model	Length	Opening	Weight	Material	Barcode
0407.010	190	6	338	6	8011578943868



## 408 TRONCHESE TAGLIENTE FRONTALE - acciaio chrom-vanadium finitura cromata - impugnatura isolata

END CUTTING NIPPERS - chrom-vanadium steel chrome plated finish- insulated handle



DIN 5748







0408.016 160 22 240 6 8011578914837

## 409 TRONCHESE TAGLIO DIAGONALE GRANDE EFFETTO - acciaio chrom-vanadium finitura cromata - impugnatura isolata

HEAVY DUTY DIAGONAL CUTTING NIPPERS - chrom-vanadium steel chrome plated finish - insulated handle



DIN ISO 5749







0409.018 180 20 272 6 8011578914868

## 410 TRONCHESE TAGLIO DIAGONALE A LEVA ALTA - INDUSTRIA - acciaio chrom-vanadium EXTRA finitura lucida

HIGH LEVERAGE CUTTER WITH DIAGONAL CUTTING - INDUSTRIAL- chrom-vanadium EXTRA steel polish finish

**Impugnatura isolata morbida bicomponente**  
Insulated bicomponent soft handle

Capacità taglio ø 4 mm ferro - ø 1,6 acciaio armonico  
Cut capacity ø 4 mm iron - ø 1,6 piano steel  
Tagliante - Cut 58-63° HRC  
Pinza - Plier 43-48° HRC

DIN ISO 5749







0410.016 160 22 222 6 8011578967000 **new**



## 412Z TRONCHESE TAGLIO DIAGONALE - acciaio chrom-vanadium finitura cromata

CUTTER WITH DIAGONAL CUTTING - chrom-vanadium steel chrome plated finish

**COMMOGRIP MUNDIAL** Impugnatura isolata morbida bicomponente in gomma-pvc  
Insulated bicomponent soft handle in rubber-pvc



DIN ISO 5749









0412.916 160 20 230 6 8011578915018

**414** TRONCHESE TAGLIO INCLINATO - acciaio chrom-vanadium finitura lucida - impugnatura plasticata  
 CUTTER WITH OBLIQUE CUTTING - chrom-vanadium polished finish steel - plastic handle

       
 0414.015 150 20 150 6 8011578915049



**415** TRONCHESE TAGLIO INCLINATO PER MATERIALE PLASTICO - FILO RASO  
 DIAGONAL CUTTER FOR PLASTIC- FLUSH CUTTING EDGE

       
 0415.016 160 142 6 8011578942069



**416** TRONCHESE TAGLIO OBLIQUO PER MATERIALE PLASTICO - FILO RASO - acciaio chrom-vanadium finitura lucida  
 CUTTER WITH OBLIQUE CUTTING FOR PLASTIC- FLUSH CUTTING EDGE - chrom-vanadium polished finish steel

       
 0416.010 150 20 132 6 8011578967024

new



**417** TENAGLIE PER CEMENTISTI - acciaio finitura verniciata - impugnatura plasticata  
 TOWER PINCERS - steel varnished finish - plastic handle

DIN ISO 9242

       
 0417.020 200 22 206 6 8011578915070  
 0417.022 220 23 308 6 8011578915100  
 0417.025 250 25 422 6 8011578915131



**417.900** ESPOSITORE IN CARTONE 18 TENAGLIE  
 CARTON DESK DISPLAY 18 PINCERS

Contenuto-content:  
 0417.022 Nr. 12  
 0417.025 Nr. 6

     
 0417.900 260 x 260 x 260 7000 8011578947507



## 418 TENAGLIE PER CEMENTISTI EXTRA - acciaio chrom-vanadium

TOWER PINCERS EXTRA - chrom-vanadium steel



DIN ISO 9242

Icona	Dimensione	Spessore	Capacità	Quantità	Barcode
	180	23	316	6	8011578915162
	220	25	382	6	8011578915193
	280	25	462	6	8011578947521

## 420 TENAGLIE PER CEMENTISTI EXTRA - acciaio chrom-vanadium - impugnatura plasticata

TOWER PINCERS EXTRA - chrom-vanadium steel - plastic handle



DIN ISO 9242

Icona	Dimensione	Spessore	Capacità	Quantità	Barcode
	180	23	340	6	8011578915223
	220	25	394	6	8011578915254
	280	25	472	6	8011578942946

## 420.900 ESPOSITORE IN CARTONE 18 TENAGLIE

CARTON DESK DISPLAY 18 PINCERS



Contenuto-content:

0420.022 Nr. 12

0420.025 Nr. 6

Icona	Dimensione	Capacità	Quantità	Barcode
	260 x 260 x 260	7114	6	8011578947545

## 423 TENAGLIE PICCOLE - acciaio chrom-vanadium finitura fosfatata - impugnatura plasticata

END CUTTING SMALL PINCERS - chrom-vanadium steel phosphated finish - plastic handle



Icona	Dimensione	Spessore	Capacità	Quantità	Barcode
	180	25	248	6	8011578915285

## 425 TENAGLIE PER FALEGNAMI - acciaio - impugnatura plasticata

PINCERS FOR CARPENTERS - steel - plastic handle



DIN ISO 9243

Icona	Dimensione	Spessore	Capacità	Quantità	Barcode
	180	23	282	6	8011578915315
	200	25	398	6	8011578915346

**430** PINZA CALZOLAI CON MARTELLO  
 SHOEMAKERS PLIERS WITH HAMMER

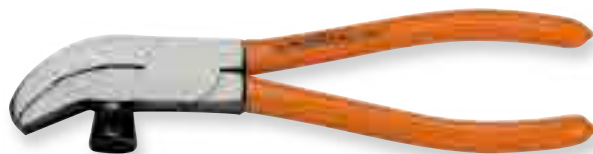

   
 0430.010 200

    
 356 6 8011578934385

**431** PINZA CALZOLAI RETTA  
 SHOEMAKERS PLIERS - STRAIGHT



   
 0431.010 200

    
 396 6 8011578934408

**432** PINZA CALZOLAI CURVA  
 SHOEMAKERS PLIERS - BENT





   
 0432.010 200

    
 403 6 8011578934422

**435** PINZA CHIUSURA GANCI RETI TIPO PICCOLO - finitura verniciata - impugnatura plasticata  
 PLIER FOR CLOSING HOOKS FOR NETS - SMALL - varnished finish - plastic handle

       
**0435.010** 210 foro-hole Ø 6,3 250 **6** 8011578915407





**435.** PINZA CHIUSURA GANCI RETI TIPO PICCOLO + 1 KG. GANCI  
 PLIER FOR CLOSING HOOKS FOR NETS - SMALL + 1 KG. HOOKS

       
**0435.015** 210 foro-hole Ø 6,3 1260 **1** 8011578968007 **new**

**435...** GANCI PER RETI - piccoli - finitura zincata  
 HOOKS FOR NETS - small - zinc finish

mm. 15 x 5



      
**0435.110** ART. 435/A Kg. 1 **1** 8011578435103  
**0435.210** ART. 435/B Kg. 5 **1** 8011578435127  
**0435.310** ART. 435/C Kg. 25 **1** 8011578435158

**435X** GANCI PER RETI - piccoli - acciaio inox  
 HOOKS FOR NETS - small - stainless

mm. 15 x 5







      
**0435.901** Kg. 1 **1** 8011578435189  
**0435.905** Kg. 5 **1** 8011578435219  
**0435.925** Kg. 25 **1** 8011578435240

**436.** PINZA CHIUSURA GANCI RETI TIPO GRANDE - finitura verniciata - impugnatura plasticata  
 PLIERS FOR CLOSING HOOKS FOR NETS - BIG - varnished finish - plastic handle

       
**0436.010** 210 foro-hole Ø 9,3 253 **6** 8011578915612





**436** PINZA CHIUSURA GANCI RETI TIPO GRANDE + 1 KG. GANCI  
 PLIERS FOR CLOSING HOOKS FOR NETS - BIG + 1 KG. HOOKS

       
**0436.015** 210 foro-hole Ø 9,3 1263 **1** 8011578968021 **new**

**436...** GANCI PER RETI - grandi - finitura zincata  
 HOOKS FOR NETS - big - zinc finish

mm. 22 x 7



      
**0436.110** ART. 436/A Kg. 1 **1** 8011578436155  
**0436.210** ART. 436/B Kg. 5 **1** 8011578436209  
**0436.310** ART. 436/C Kg. 25 **1** 8011578436254

**436X** GANCI PER RETI - grandi - acciaio inox  
 HOOKS FOR NETS - big - stainless

mm. 22 x 7



      
**0436.901** Kg. 1 **1** 8011578436308  
**0436.905** Kg. 5 **1** 8011578436353  
**0436.925** Kg. 25 **1** 8011578436407

**437** PINZA CHIUSURA GANCI GABBIONI E PALI - finitura verniciata - impugnatura plasticata  
 PLIER FOR CLOSING HOOKS FOR GABIONS AND POST - varnished finish - plastic handle

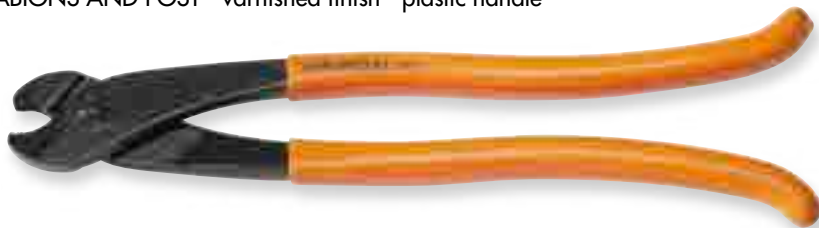

 0437.010 270

  462 2 8011578968045

new

**437A** GANCI PER GABBIONI E PALI - finitura zincata  
 HOOKS FOR GABIONS AND POST - zinc finish



 0437.110

  Kg. 1 1 8011578968069

**438** PINZA CHIUSURA GRAFFE - finitura verniciata - impugnatura plasticata  
 PLIERS FOR CLOSING CLIPS - varnished finish - plastic handle



 0438.010 180

  246 6 8011578915827

**438Z** PINZA AUTOMATICA CHIUSURA GRAFFE  
 AUTOMATIC PLIERS FOR CLOSING CLIPS









 0438.910

  320 1 8011578943509

**438...** GRAFFE PER 438 - finitura zincata  
 CLIPS FOR 438 - zinc finish



mm. 21

 **0438.110** ART. 438/A   Kg. 1 1 8011578438104  
**0438.210** ART. 438/B   Kg. 5 1 8011578438159  
**0438.310** ART. 438/C   Kg. 25 1 8011578438203

**438Z...** GRAFFE IN STECCA INCOLLATA (50 graffe cad.)  
 CLIP IN STICK (50 stick each)

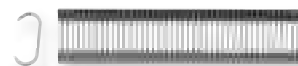

 **0438.930**

  22 **500** 8011578942960

## 439C ESPOSITORE 36 PINZE E TENAGLIE DISPLAY STAND 36 PLIERS AND PINCERS

Contenuto-content:

0490.018 Nr. 6 0420.025 Nr. 6  
 0490.024 Nr. 6 0404.020 Nr. 6  
 0420.022 Nr. 6 0425.020 Nr. 6

			
<b>0439.310</b>	475 x 215 x 180	15600	8011578439033
<b>0439.220</b>	vuoto - empty	4150	8011578916008



## 439.900 ESPOSITORE IN CARTONE 18 PINZE E TRONCHESI CARTON DESK DISPLAY 18 PLIERS AND CUTTER

Contenuto-content:

0440.918 Nr. 12  
 0412.916 Nr. 3  
 0463.916 Nr. 3

			
<b>0439.900</b>	260 x 260 x 260	5000	8011578947569



## 439.911 ESP. IN CARTONE 18 PINZE UNIV. CARTON DESK DISPLAY 18 PLIERS

- LEVA ALTA INDUSTRIA  
 - HIGH LEVERAGE INDUSTRIAL

Contenuto-content:

0441.018 Nr. 12  
 0410.016 Nr. 3  
 0462.016 Nr. 3

			
<b>0439.911</b>	260 x 260 x 260 <b>new</b>	5000	8011578968083



## 439.912 ESP. IN CARTONE 18 PINZE UNIV. CARTON DESK DISPLAY 18 PLIERS

Contenuto-content:

0456.016 Nr. 3  
 0456.018 Nr. 12  
 0456.020 Nr. 3

			
<b>0439.912</b>	260 x 260 x 260	4300	8011578947583





## 439ZF ESPOSITORE 36 PINZE E TRONCHESI - finitura cromata - metallo DISPLAY STAND 36 PLIERS AND CUTTERS - chrome plated finish - metal

**COMMOGRIP** **MUNDIAL** Impugnatura isolata morbida bicomponente in gomma-pvc  
 Insulated bicomponent soft handle in rubber-pvc

Contenuto-content:

0412.916 160 Nr. 6  
 0440.916 160 Nr. 6  
 0440.918 180 Nr. 6  
 0463.916 160 Nr. 6  
 0466.916 160 Nr. 6  
 0467.916 160 Nr. 6

			
<b>0439.915</b>	475 x 215 x 180	11600	8011578439200
<b>0439.220</b>	vuoto - empty	4150	8011578916008



**440Z**

**PINZA UNIVERSALE - acciaio chrom-vanadium finitura cromata**  
**COMBINATION PLIERS - chrom-vanadium steel chrome plated finish**



**Impugnatura isolata morbida bicomponente in gomma-pvc**  
**Insulated bicomponent soft handle in rubber-pvc**



DIN ISO 5746

<b>0440.916</b>	<b>160</b>	5,5 x 9,5	33,5	210	<b>6</b>	8011578916152
<b>0440.918</b>	<b>180</b>	5,8 x 10,0	36,5	264	<b>6</b>	8011578916183
<b>0440.920</b>	<b>200</b>	7,0 x 10,5	39,5	318	<b>6</b>	8011578916213

**441**

**PINZA UNIVERSALE A LEVA ALTA - INDUSTRIA - acciaio chrom-vanadium EXTRA finitura lucida**  
**HIGH LEVERAGE COMBINATION PLIERS - INDUSTRIAL - chrom-vanadium EXTRA steel polish finish**

**Impugnatura isolata morbida bicomponente**  
**Insulated bicomponent soft handle**

distanza ridotta - riduce lo sforzo del 45%  
 reduced distance - less effort of 45%



Tagliente - Cut 58-63° HRC  
 Pinza - Plier 43-48° HRC

DIN ISO 5746

<b>0441.018</b>	<b>180</b>	5,8 x 10,0	41,0	285	<b>6</b>	8011578967048

new

**456**

**PINZA UNIVERSALE - acciaio chrom-vanadium finitura cromata - impugnatura plasticata**  
**COMBINATION PLIERS - chrom-vanadium steel chrome plated finish - plastic handle**



DIN ISO 574

<b>0456.016</b>	<b>160</b>	5,5 x 9,5	33,5	162	<b>6</b>	8011578916336
<b>0456.018</b>	<b>180</b>	5,8 x 10,0	36,5	218	<b>6</b>	8011578916367
<b>0456.020</b>	<b>200</b>	7,0 x 10,5	39,5	274	<b>6</b>	8011578916398

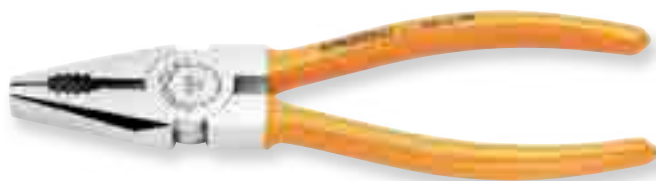

**462**

**PINZA BECCHI MEZZOTONDI CON TAGLIENTE A LEVA ALTA - INDUSTRIA - acciaio chrom-vanadium EXTRA finitura lucida**  
**HIGH LEVERAGE HALF NOSE PLIERS WITH CUTTER - INDUSTRIAL - chrom-vanadium EXTRA steel polish finish**

**Impugnatura isolata morbida bicomponente**  
**Insulated bicomponent soft handle**

distanza ridotta - riduce lo sforzo del 45%  
 reduced distance - less effort of 45%



Tagliente - Cut 58-63° HRC  
 Pinza - Plier 43-48° HRC

<b>0462.016</b>	<b>160</b>	3 x 2,5	53	174	<b>6</b>	8011578968106







new



**463Z** PINZA BECCHI MEZZOTONDI CON TAGLIENTE - cromata  
 HALF NOSE PLIERS WITH CUTTER - chrome



●







						
0463.916	170	3 x 2,5	61	154	6	8011578916725
0463.920	200	3 x 2,5	77	213	6	8011578916756

**466Z** PINZA BECCHI MEZZOTONDI PIEGATI CON TAGLIENTE E GIRATUBO - acciaio chrom-vanadium finitura cromata  
 BENT LONG HALF NOSE PLIERS WITH CUTTER AND PIPE GRIP - chrom-vanadium steel chrome plated finish



●

DIN ISO 5745







						
0466.916	170	3 x 2,5	61	162	6	8011578916909
0466.920	200	3 x 2,5	77	208	6	8011578916930

**467Z** PINZA BECCHI PIATTI RETTI - acciaio chrom-vanadium finitura cromata  
 FLAT STRAIGHT NOSE PLIERS - chrom-vanadium steel chrome plated finish



■

DIN ISO 5745







						
0467.916	160	3 x 5	49	172	6	8011578917050

**469Z** PINZA BECCHI TONDI RETTI - acciaio chrom-vanadium finitura cromata  
 ROUND STRAIGHT NOSE PLIERS - chrom-vanadium steel chrome plated finish



●







DIN ISO 5745

						
0469.916	160	2,5	49	142	6	8011578917142



**470** PINZA SPELAFILI - acciaio chrom-vanadium finitura cromata - impugnatura isolata  
 WIRE STRIPPING PLIERS - chrom-vanadium steel chrome plated finish - insulated handle



        
 0470.016 160 0,6 x 10 40 180 6 8011578917173

**472** PINZA COMBINATA PER GOMMISTI - acciaio chrom-vanadium finitura cromata - impugnatura plasticata  
 WHEEL BALANCE WEIGHT PLIERS - chrom vanadium steel chrome plated finish - plastic handle



      
 0472.010 240 366 6 8011578917203

**474** PINZA AUTOBLOCCANTE GANASCE CONCAVE - acciaio chrom-vanadium finitura nichelata  
 LOCK-GRIP PLIERS CONCAVE JAWS - chrom-vanadium steel nickel plated finish



      
 0474.014 140 182 2 8011578963385  
 0474.018 180 370 2 8011578917234  
 0474.025 250 610 2 8011578917265

**476** PINZA AUTOBLOCCANTE PER SALDATORI - acciaio chrom-vanadium finitura nichelata  
 LOCK-GRIP PLIERS FOR WELDER - chrom-vanadium steel nickel plated finish



      
 0476.010 270 804 2 8011578917326

**478**

**PINZA AUTOBLOCCANTE A MORSETTO - acciaio chrom-vanadium finitura nichelata**  
 CLAMP LOCK-GRIP PLIERS - chrom-vanadium steel nickel plated finish



  
 0478.010

 280

  802 2  8011578917357

**478Z**

**PINZA AUTOBLOCCANTE A MORSETTO CON BASCULANTI - acciaio chrom-vanadium finitura nichelata**  
 CLAMP LOCK-GRIP PLIER WITH SWIVEL PAD - chrom-vanadium steel nickel plated finish

basculante  
 swivel pad



  
 0478.910

 280

  985 2  8011578963446

**new**

**479**

**PINZA AUTOBLOCCANTE - ganasce lunghe**  
 LOCK-GRIP PLIERS - long jaws



  
 0479.016  
 0479.020

 160  
 220

  174 2 8011578934446  
 180 2 8011578934460



**490** PINZA REGOLABILE CERNIERA CHIUSA - acciaio chrom-vanadium finitura verniciata - impugnatura plasticata  
 WATERPUMP JOINT BOX PLIERS - chrom-vanadium steel varnished finish - plastic handle



DIN ISO 8976

Model	Length (mm)	Weight (kg)	Material	Barcode
0490.018	180	175	6	8011578938680
0490.024	240	300	6	8011578917388
0490.030	300	434	6	8011578917418

**490.900** ESPOSITORE IN CARTONE 18 PINZE  
 CARTON DESK DISPLAY 18 PLIERS



Contenuto-content:

- 0490.018 Nr. 3
- 0490.024 Nr. 12
- 0490.030 Nr. 3

Model	Dimensions (mm)	Weight (kg)	Barcode
0490.900	260 x 260 x 260	6200	8011578947606

**491** PINZA REGOLABILE CERNIERA CHIUSA A PULSANTE - acciaio chrom-vanadium finitura verniciata  
 WATERPUMP BOX JOINT PLIER WITH PUSH BUTTON - chrom-vanadium steel varnished finish

impugnatura plasticata  
 plastic handle

pulsante  
 push button



DIN ISO 8976

Model	Length (mm)	Weight (kg)	Material	Barcode	Status
0491.024	240	330	6	8011578963408	new
0491.030	300	560	6	8011578965907	new

**491.900** ESPOSITORE IN CARTONE 18 PINZE A PULSANTE  
 CARTON DESK DISPLAY 18 PLIERS WITH PUSH BUTTON



Contenuto-content:  
 0491.024 Nr. 18

Model	Dimensions (mm)	Weight (kg)	Barcode
0491.900	260 x 260 x 260	6000	8011578963422

## 492 PINZA REGOLABILE - Regolazione Automatica

### WATERPUMP PLIERS - Automatic

si adatta automaticamente alle dimensioni da serrare con una sola mano  
 automatic adjustment to the dimensions to close with one hand



regolazione automatica  
 automatic

Icona	Dimensione	Spessore	Quantità	Barcode	Numero
	180	168	6	8115781000004	8011578943783
	240	355	6	8115781000004	8011578943806
	300	560	6	8115781000004	8011578943820

## 492.900 ESPOSITORE 18 PINZE AUTOMANICHE

### DISPLAY 18 AUTOMATIC PLIERS

Contenuto-content:

0492.018 Nr. 3

0492.024 Nr. 12

0492.030 Nr. 3



Icona	Dimensione	Spessore	Quantità	Barcode	Numero
	260 x 260 x 260	7200		8115781000004	8011578947620

## 495 PINZA REGOLABILE A CREMAGLIERA - acciaio chrom-vanadium finitura cromata - impugnatura plasticata

### DOUBLE GROOVE JOINT PLIERS - chrom-vanadium steel chrome plated finish - plastic handle



DIN ISO 8976

Icona	Dimensione	Spessore	Quantità	Barcode	Numero
	240	380	6	8115781000004	8011578917449

## 500 GIRATUBO TIPO LEGGERO

### PIPE WRENCH

Icona	Ø	Dimensione	Spessore	Quantità	Barcode	Numero
	1"	175	326	2	8115781000004	8011578934606
	1-1/2"	225	560	2	8115781000004	8011578934620
	2"	275	780	2	8115781000004	8011578934644
	2-1/2"	300	1020	2	8115781000004	8011578934668
	3"	350	1060	2	8115781000004	8011578960964



new

## 501 PINZA PER DADI RUBINETTI - finitura lucida - impugnatura plasticata





### NUT PLIERS - polished finish - plastic handle



Icona	Dimensione	Spessore	Quantità	Barcode	Numero
	250	474	6	8115781000004	8011578917470





**502** GIRATUBO SVEDESE 45° - acciaio chrom-vanadium finitura verniciata  
 PIPE WRENCH-SWEDISH 45° - chrom-vanadium steel varnished finish

DIN 5234 B

	Ø	—L—			
0502.025	1/2"	250	378	2	8011578917500
0502.032	1"	320	774	2	8011578917531
0502.040	1-1/2"	400	1334	2	8011578917562
0502.054	2"	530	2400	1	8011578917593
0502.065	3"	650	4100	1	8011578934484







**502S** GIRATUBO SVEDESE 45° - ganasce S  
 PIPE WRENCH-SWEDISH 45° - S jaws

	Ø	—L—			
0502.725	1/2"	250	396	2	8011578934507
0502.732	1"	320	802	2	8011578934521
0502.740	1-1/2"	400	1500	2	8011578934545
0502.754	2"	530	2500	1	8011578934569
0502.765	3"	650	4200	1	8011578934583







**503** GIRATUBO SVEDESE 90° - acciaio chrom-vanadium finitura verniciata  
 PIPE WRENCH-SWEDISH 90° - chrom-vanadium steel varnished finish

DIN 5234A

	Ø	—L—			
0503.030	1"	320	722	2	8011578917623
0503.041	1-1/2"	425	1254	2	8011578917654
0503.052	2"	560	2400	1	8011578917685
0503.062	3"	620	3200	1	8011578947644



**504** GIRATUBO AMERICANO - acciaio chrom-vanadium finitura verniciata  
 PIPE WRENCH-AMERICAN - chrom-vanadium steel varnished finish

	Ø	—L—			
0504.020	1"	8"- 200	364	2	8011578917715
0504.025	1-1/2"	10"- 250	752	2	8011578917746
0504.030	2"	12"- 300	1006	2	8011578917777
0504.035	2"	14"- 350	1556	2	8011578917807
0504.045	2-1/2"	18"- 450	2400	1	8011578917838
0504.060	3"	24"- 600	3700	1	8011578917869
0504.090	4"	36"- 900	7850	1	8011578960445



new

**504A** GIRATUBO AMERICANO - alluminio  
 PIPE WRENCH-AMERICAN - aluminium

Icon	Ø	l-L	Weight	Box	Barcode
	2-1/2"	18" - 450	1400	1	8011578934682
	3"	24" - 600	2400	1	8011578934705
	4"	36" - 900	4000	1	8011578934729

**504S** GIRATUBO STILSON - acciaio  
 PIPE WRENCH STILSON - steel

Icon	Ø	l-L	Weight	Box	Barcode	Status
	1-1/2"	10" - 250	485	2	8011578967109	new
	2"	14" - 350	974	2	8011578967123	new
	2-1/2"	18" - 450	1507	1	8011578967147	new
	3"	24" - 600	2564	1	8011578967161	new
	4"	36" - 900	4674	1	8011578967185	new

**504ZF** GIRATUBO A CATENA REVERSIBILE  
 PIPE WRENCH-CHAIN REVERSIBLE

Icon	Ø	l-L	Weight	Box	Barcode
	4"	300	783	1	8011578944209

**504ZT** GIRATUBO A CATENA REVERSIBILE  
 PIPE WRENCH-CHAIN REVERSIBLE

Icon	Ø	l-L	Weight	Box	Barcode	Status
	6"	900	9400	1	8011578967208	new





**504ZZ** GIRATUBO A NASTRO  
 BELT WRENCH

Icon	Ø	Weight	Box	Barcode	Status
	90	414	1	8011578968120	new



**505** PINZA PER ANELLI ELASTICI ESTERNI BECCHI DIRITTI - acciaio chrom-vanadium - impugnatura plasticata  
 EXTERNAL LOCK RING PLIERS-STRAIGHT - chrom-vanadium steel - plastic handle





DIN 5254A

Icona	Immagine	Ø	Ø	Icona	Icona	Barcode
		8 ÷ 25	1,3			011578  000004
<b>0505.014</b>	<b>140</b>			102	<b>6</b>	8011578917890
<b>0505.018</b>	<b>180</b>	19 ÷ 60	1,8	180	<b>6</b>	8011578917920
<b>0505.022</b>	<b>220</b>	40 ÷ 100	2,3	258	<b>6</b>	8011578917951
<b>0505.032</b>	<b>320</b>	85 ÷ 200	3,2	490	<b>2</b>	8011578943462



**506** PINZA PER ANELLI ELASTICI ESTERNI BECCHI PIEGATI - acciaio chrom-vanadium - impugnatura plasticata  
 EXTERNAL LOCK RING PLIERS-BENT - chrom-vanadium steel - plastic handle





DIN 5254B

Icona	Immagine	Ø	Ø	Icona	Icona	Barcode
		8 ÷ 25	1,3			011578  000004
<b>0506.013</b>	<b>130</b>			102	<b>6</b>	8011578917982
<b>0506.017</b>	<b>170</b>	19 ÷ 60	1,8	180	<b>6</b>	8011578918019
<b>0506.021</b>	<b>210</b>	40 ÷ 100	2,3	264	<b>6</b>	8011578918040
<b>0506.031</b>	<b>310</b>	85 ÷ 200	3,2	502	<b>2</b>	8011578947668



**510** PINZA PER ANELLI ELASTICI INTERNI BECCHI DIRITTI - acciaio chrom-vanadium - impugnatura plasticata  
 INTERNAL LOCK RING PLIERS-STRAIGHT - chrom-vanadium steel - plastic handle





DIN 5256C

Icona	Immagine	Ø	Ø	Icona	Icona	Barcode
		8 ÷ 25	1,3			011578  000004
<b>0510.014</b>	<b>140</b>			100	<b>6</b>	8011578918071
<b>0510.018</b>	<b>180</b>	19 ÷ 60	1,8	166	<b>6</b>	8011578918101
<b>0510.022</b>	<b>220</b>	40 ÷ 100	2,3	262	<b>6</b>	8011578918132
<b>0510.032</b>	<b>320</b>	85 ÷ 200	3,2	433	<b>2</b>	8011578943486



**511** PINZA PER ANELLI ELASTICI INTERNI BECCHI PIEGATI - acciaio chrom-vanadium - impugnatura plasticata  
 INTERNAL LOCK RING PLIERS-BENT - chrom-vanadium steel - plastic handle

DIN 5256D

Icona	Immagine	Ø	Ø	Icona	Icona	Barcode
		8 ÷ 25	1,3			011578  000004
<b>0511.013</b>	<b>130</b>			106	<b>6</b>	8011578918163
<b>0511.017</b>	<b>170</b>	19 ÷ 60	1,8	156	<b>6</b>	8011578918194
<b>0511.021</b>	<b>210</b>	40 ÷ 100	2,3	268	<b>6</b>	8011578918224
<b>0511.031</b>	<b>310</b>	85 ÷ 200	3,2	414	<b>2</b>	8011578947682



**512A** ESP. 36 PINZE PER ANELLI ELASTICI - metallo  
 DISPLAY STAND 36 LOCK RING PLIERS - metal



Contenuto-content:

0505.014	140	Nr. 6	0506.017	170	Nr. 6	0510.018	180	Nr. 6
0505.018	180	Nr. 6	0510.014	140	Nr. 6	0511.017	170	Nr. 6

Icona	Immagine	Icona	Barcode
			011578  000004
<b>0512.110</b>	475 x 215 x 180	9500	8011578512002
<b>0439.220</b>	vuoto - empty	4150	8011578916008

**512.900** ESP. IN CARTONE 18 PINZE ANELLI  
 CARTON DESK DIS. 18 PLIERS CIRCLIP



Contenuto-content:

0505.018	Nr. 6
0506.017	Nr. 3
0510.018	Nr. 6
0511.017	Nr. 3

Icona	Immagine	Icona	Barcode
			011578  000004
<b>0512.900</b>	260 x 260 x 260	3800	8011578947705



## 520 PINZA PER ELETTRONICA BECCHI PIATTI - acciaio chrom-vanadium finitura lucida

ELECTRONIC PLIERS-FLAT NOSE - chrom-vanadium polished finish steel



Impugnatura isolata morbida bicomponente in gomma-pvc  
 Insulated bicomponent soft handle in rubber-pvc



=

	←-L-→			
0520.010	120	66	6	8011578918552

## 522 PINZA PER ELETTRONICA BECCHI TONDI

ELECTRONIC PLIERS-ROUND NOSE

●

	←-L-→			
0522.010	120	70	6	8011578918583



## 524 PINZA PER ELETTRONICA BECCHI MEZZ. PIEGATI

ELECTRONIC PLIERS-BENT HALF ROUND NOSE

◐

	←-L-→			
0524.010	120	66	6	8011578918613



## 525 PINZA PER ELETTRONICA BECCHI MEZZ. LUNGI

ELECTRONIC PLIERS-LONG HALF ROUND NOSE

◐

	←-L-→			
0525.010	150	78	6	8011578918644



## 526 TRONCHESE TAGLIO DIAGONALE PER ELETTRONICA

ELECTRONIC DIAGONAL CUTTER

	←-L-→			
0526.010	115	72	6	8011578918675



**527** TRONCHESE TAGLIO FRONTALE PER ELETTRONICA  
 ELECTRONIC FRONT CUTTER

      
**0527.010** 115 70 **6** 8011578918705



**528** PINZA UNIV. PER ELETTR. BECCHI MEZZ. CON TAGL.  
 EL. COMB. PLIERS-HALF ROUND NOSE WITH CUT.

       
**0528.010** 120 78 **6** 8011578918736



**529.900** ESPOSITORE IN CARTONE 18 PINZE ELETTRONICA  
 CARTON DESK DISPLAY 18 PLIERS ELECTRONIC



Contenuto-content:

0520.010 Nr. 2 0526.010 Nr. 6  
 0522.010 Nr. 2 0527.010 Nr. 2  
 0524.010 Nr. 2 0528.010 Nr. 2  
 0525.010 Nr. 2

      
**0529.900** 260 x 260 x 260 1980 8011578947729





**533** TRONCHESE PER ELETTRONICA TESTA ARROTONDATA - PROFESSIONALE - acciaio chrom-vanadium finitura lucida  
 ELECTRONIC DIAGONAL CUTTER ROUND TIP - PROFESSIONAL - chrom-vanadium polished finish steel

      
**0533.010** 125 80 **6** 8011578967062 **new**



**534** TRONCHESE ELETTRONICA TESTE APPUNTITE - PROFESSIONALE - acciaio chrom-vanadium finitura lucida  
 ELECTRONIC DIAGONAL CUTTER STRAIGHT TIP - PROFESSIONAL - chrom-vanadium polished finish steel

      
**0534.010** 125 68 **6** 8011578967086 **new**



**532A** PINZETTA PLASTICATA - punte arrotondate rette  
 TWEEZERS WITH PLAST. HANDLE - str. round tips



      
 0532.110 160 30 6 8011578918828

**540B** PINZETTA - punte arrotondate curve - fin. nic.  
 TWEEZERS - bent round tips - nic. pl. fin.



      
 0540.210 150 28 6 8011578919009

**532B** PINZETTA PLASTICATA - punte arrotondate curve  
 TWEEZERS WITH PLAST. HANDLE - bent round tips



      
 0532.210 155 32 6 8011578918859

**541B** PINZETTA AUTOBLOCCANTE - punte curve  
 TWEEZERS SELF-LOCKING - bent tips



      
 0541.210 165 30 6 8011578919061

**540A** PINZETTA - punte arrotondate rette - fin. nic.  
 TWEEZERS - str. round tips - nick. plat. fin.



      
 0540.110 150 24 6 8011578918972

**558** PUNTA A TRACCIARE  
 SCRIBER



      
 0558.010 150 40 12 8011578919245

**552** PINZA FUSTELLATRICE  
 PUNCH PLIER



      
 0552.010 220 290 2 8011578965723

new

**553** PINZA FUSTELLATRICE DOPPIA LEVA  
 DOUBLE LEVER PUNCH PLIER





      
 0553.010 240 380 2 8011578965747

new





**559** **CESOIA TIPO ITALIA - acciaio finitura lucida - impugnatura plasticata**  
**ITALIAN PATTERN TIN SNIP - polished finish steel - plastic handle**

Icona	L	Peso	Quantità	Barcode
	↔ L ↔			811578 000004
0559.022	220	368	2	8011578919276
0559.024	240	480	2	8011578919306
0559.026	260	500	2	8011578919337
0559.030	300	796	2	8011578919368



**560** **CESOIA TIPO AMERICA - acciaio finitura lucida - impugnatura plasticata**  
**AMERICAN PATTERN TIN SNIP - polished finish steel - plastic handle**

Icona	L	Peso	Quantità	Barcode
	↔ L ↔			811578 000004
0560.020	200	286	2	8011578919399
0560.025	250	456	2	8011578919429
0560.030	300	728	2	8011578919450



**561** **CESOIA DOPPIA LEVA TAGLIO DESTRO - PROFESSIONALE**  
**LEVER TIN SNIP - RIGHT CUT - PROFESSIONAL**

taglio lamiera - metal sheet cut mm. 1,8  
 taglio lamiera inox - stainless steel sheet cut mm. 1,2

Icona	L	Peso	Quantità	Barcode
	↔ L ↔			811578 000004
0561.010	250	480	2	8011578944063



**562** **CESOIA DOPPIA LEVA TAGLIO SINISTRO - PROFESSIONALE**  
**LEVER TIN SNIP - LEFT CUT - PROFESSIONAL**

taglio lamiera - metal sheet cut mm. 1,8  
 taglio lamiera inox - stainless steel sheet cut mm. 1,2

Icona	L	Peso	Quantità	Barcode
	↔ L ↔			811578 000004
0562.010	250	475	2	8011578944087



**563** **CESOIA DOPPIA LEVA TAGLIO DRITTO - PROFESSIONALE**  
**LEVER TIN SNIP - STRAIGHT CUT - PROFESSIONAL**

taglio lamiera - metal sheet cut mm. 1,8  
 taglio lamiera inox - stainless steel sheet cut mm. 1,2

Icona	L	Peso	Quantità	Barcode
	↔ L ↔			811578 000004
0563.010	250	470	2	8011578944100



## 564 CESCOIA DOPPIA LEVA TAGLIO DESTRO - acciaio chrom-vanadium - impugnatura isolata

### LEVER TIN SNIP - RIGHT CUT - chrom-vanadium steel - insulated handle

taglio lamiera - metal sheet cut mm. 1,5  
 taglio lamiera inox - stainless steel sheet cut mm. 1,0



 **0564.010**  250   **2**  80115781000004 8011578919481

## 565 CESCOIA DOPPIA LEVA TAGLIO SINISTRO - acciaio chrom-vanadium - impugnatura isolata

### LEVER TIN SNIP - LEFT CUT - chrom-vanadium steel - insulated handle

taglio lamiera - metal sheet cut mm. 1,5  
 taglio lamiera inox - stainless steel sheet cut mm. 1,0



 **0565.010**  250   **2**  80115781000004 8011578919511

## 566 CESCOIA DOPPIA LEVA TAGLIO DIRITTO - acciaio chrom-vanadium - impugnatura isolata

### LEVER TIN SNIP - STRAIGHT CUT - chrom-vanadium steel - insulated handle

taglio lamiera - metal sheet cut mm. 1,5  
 taglio lamiera inox - stainless steel sheet cut mm. 1,0



 **0566.010**  250   **2**  80115781000004 8011578919542

## 567 CESCOIA DOPPIA LEVA - taglio passante - destro - professionale

### LEVER TIN SNIP CUT - through cuts - right - professional

taglio lamiera - metal sheet cut mm. 1,8  
 taglio lamiera inox - stainless steel sheet cut mm. 1,2



 **0567.010**  250   **2**  80115781000004 8011578934743

## 568 CESCOIA DOPPIA LEVA - taglio passante - sinistro - professionale

### LEVER TIN SNIP CUT - through cuts - left - professional

taglio lamiera - metal sheet cut mm. 1,8  
 taglio lamiera inox - stainless steel sheet cut mm. 1,2



 **0568.010**  250   **2**  80115781000004 8011578934767



**569** CESCOIA RODITORE PROFESSIONALE  
 NIBBLER - PROFESSIONAL

taglio lamiera - metal sheet cut mm. 1,2  
 taglio lamiera inox - stainless steel sheet cut mm. 1,0



				
<b>0569.010</b>	250	486	<b>2</b>	8011578934781

**570** COLTELLO PER ELETTRICISTI  
 KNIFE FOR ELECTRICIANS



				
<b>0570.010</b>	80	78	<b>12</b>	8011578919573





**572** RIVETTATRICE PROFESSIONALE  
 RIVETER - PROFESSIONAL



				
<b>0572.010</b>	260	555	<b>2</b>	8011578947743





**574.100** LIMA PIATTA PARALLELA - taglio mezzo dolce  
 FILE - FLAT - cut second



					<b>new</b>
<b>0574.090</b>	200	200	<b>2</b>	8011578963804	
<b>0574.100</b>	250	330	<b>2</b>	8011578940027	







**574.200** LIMA MEZZO TONDA - taglio mezzo dolce  
 FILE - HALF ROUND - cut second



					<b>new</b>
<b>0574.190</b>	200	210	<b>2</b>	8011578963828	
<b>0574.200</b>	250	343	<b>2</b>	8011578940041	

**574.300** LIMA TONDA - taglio mezzo dolce  
 FILE - ROUND - cut second



						<b>new</b>
<b>0574.290</b>	200	mm 8	126	<b>2</b>	8011578963842	
<b>0574.300</b>	250	mm 9	226	<b>2</b>	8011578940065	

**574.400** LIMA TRIANGOLARE - taglio mezzo dolce  
 FILE - TRIANGULAR - cut second



	→ L ←				
0574.390	200	198	2	8011578963866	<b>new</b>
0574.400	250	306	2	8011578940881	



**574.500** LIMA QUADRA - taglio mezzo dolce  
 FILE - SQUARE - cut second



	→ L ←				
0574.490	200	140	2	8011578963880	<b>new</b>
0574.500	250	238	2	8011578940904	



**574.800** RASPA PER LEGNO MEZZO TONDA - taglio mezzo dolce  
 RASP FOR WOOD - HALF ROUND - cut second



	→ L ←				
0574.790	200	196	2	8011578963903	<b>new</b>
0574.800	250	356	2	8011578940928	

**574.990** SERIE 4 LIME  
 SET 4 FILES





Contenuto-content: 0574.090 200 0574.290 200 0574.190 200 0574.390 200

				
0574.990	800	1	8011578963927	<b>new</b>



**576** SCALPELLO PER LEGNO - acciaio chrom-vanadium finitura lucida - impugnatura legno  
 WOOD CHISEL - chrom-vanadium steel polished finish - wooden handle



	mm	→ L ←				
0576.060	6	150	110	6	8011578919603	
0576.080	8	150	110	6	8011578919634	
0576.100	10	150	135	6	8011578919665	
0576.120	12	150	140	6	8011578919696	
0576.140	14	150	144	6	8011578919726	
0576.160	16	150	152	6	8011578919757	
0576.180	18	155	158	6	8011578919788	
0576.200	20	155	180	6	8011578919818	
0576.220	22	155	174	6	8011578919849	
0576.250	25	155	186	6	8011578919870	
0576.300	30	155	236	6	8011578919900	

**577** SERIE 4 SCALPELLI - manico legno  
 SET 4 CHISELS - wooden handle

Contenuto-content: 0576.080 8 0576.140 14  
 0576.100 10 0576.180 18

	→ L ←			
0577.010	320 x 220 x 40	730	8011578577001	



**580** SCALPELLO PER LEGNO - acciaio chrom-vanadium finitura lucida - impugnatura acetato  
 WOOD CHISEL - chrom-vanadium steel polished finish - acetate handle



battente acciaio  
steel

mm	L	W	W	W	W
0580.060	6	150	168	6	8011578919962
0580.080	8	150	180	6	8011578919993
0580.100	10	150	182	6	8011578960568
0580.120	12	150	190	6	8011578920050
0580.140	14	150	200	6	8011578920081
0580.160	16	150	202	6	8011578920111
0580.180	18	155	220	6	8011578920142
0580.200	20	155	220	6	8011578920173
0580.220	22	155	230	6	8011578920203
0580.250	25	155	236	6	8011578920234
0580.300	30	155	260	6	8011578920265

**581** SERIE 4 SCALPELLI - manico plastica  
 SET 4 CHISELS - plastic handle



Contenuto-content:

- 0580.080 8
- 0580.100 10
- 0580.140 14
- 0580.180 18

mm	L	W	W	W
0581.010	320 x 220 x 40	935		8011578581008

**581A** ESPOSITORE 47 SCALPELLI MANICO PLASTICA  
 DISPLAY STAND 47 CHISELS WITH PLASTIC HANDLE



Contenuto-content:

- |             |       |             |       |
|-------------|-------|-------------|-------|
| 0580.060 6  | Nr. 5 | 0580.160 16 | Nr. 5 |
| 0580.080 8  | Nr. 5 | 0580.180 18 | Nr. 5 |
| 0580.100 10 | Nr. 5 | 0580.200 20 | Nr. 4 |
| 0580.120 12 | Nr. 5 | 0580.220 22 | Nr. 4 |
| 0580.140 14 | Nr. 5 | 0580.250 25 | Nr. 4 |

mm	L	W	W	W
0581.110	410 x 230 x 200	12900		8011578581107

**582** SGORBIA PER LEGNO - acciaio chrom-vanadium finitura lucida - impugnatura legno  
 GOUGE WOOD CHISEL - BENT - chrom-vanadium steel polished finish - wooden handle



mm	L	W	W	W	
0582.060	6	130	94	6	8011578920326
0582.080	8	130	92	6	8011578920357
0582.100	10	130	96	6	8011578920388
0582.120	12	130	122	6	8011578920418
0582.140	14	130	144	6	8011578920449
0582.160	16	140	154	6	8011578920470
0582.180	18	140	172	6	8011578920500
0582.200	20	140	182	6	8011578920531



## 583 SERIE 4 SGORBIE PER LEGNO SET 4 GOUGES WOOD CHISEL

Contenuto-content:

0582.060 6  
0582.100 10  
0582.120 12  
0582.160 16



0583.010 310 x 180 x 37



705

811157811000041  
8011578583002

## 587 ESPOSITORE 47 SCALPELLI E SGORBIE LEGNO - metallo DISPLAY STAND 47 WOOD CHISELS AND GOUGES - metal

Contenuto-content:

0576.060 6 Nr. 5 0576.250 25 Nr. 4  
0576.100 10 Nr. 5 0582.080 8 Nr. 5  
0576.140 14 Nr. 5 0582.100 10 Nr. 5  
0576.160 16 Nr. 5 0582.160 16 Nr. 5  
0576.200 20 Nr. 4 0582.200 20 Nr. 4

0587.010 410 x 230 x 200  
0587.210 vuoto - empty12300  
4400811157811000041  
8011578587109  
8011578587154

## 588 MANICO PER SCALPELLI LEGNO - legno WOOD CHISELS HANDLE - wood

0588.013 130  
0588.014 14032 12  
68 12811157811000041  
8011578920685  
8011578920715

## 589 MANICO PER SCALPELLI LEGNO - acetato WOOD CHISELS HANDLE - acetate

0589.013 130  
0589.014 14072 6  
92 6811157811000041  
8011578920746  
8011578920777

## 590 ESPOSITORE 72 MANICI PER LIME - metallo DISPLAY STAND 72 HANDLES FOR FILES - metal

Contenuto-content:

0591.010 100 Nr. 12  
0591.011 110 Nr. 12  
0591.012 120 Nr. 12  
0592.010 100 Nr. 12  
0592.011 110 Nr. 12  
0592.012 120 Nr. 12

0590.010 220 x 220 x 220  
0590.210 vuoto - empty5800  
1834811157811000041  
8011578590109  
8011578590079

## 591 MANICO LIMA FORO TONDO - acetato con ghiera FILE HANDLE - ROUND HOLE - acet. with metal ring

0591.010 100 4  
0591.011 110 7  
0591.012 120 932 12  
46 12  
61 12811157811000041  
8011578920869  
8011578920890  
8011578920920

## 592 MANICO LIMA FORO PIATTO - acetato con ghiera FILE HANDLE - SLOTTED HOLE - acet. with metal ring

0592.010 100 4 x 6  
0592.011 110 5 x 8  
0592.012 120 6 x 1032 12  
46 12  
31 12811157811000041  
8011578920951  
8011578920982  
8011578921019

**593Z** ARCHETTO PROFESSIONALE IMPUGNATURA ERGONOMICA IN ALLUMINIO E ACCIAIO - Lama HSS 12"  
 PROFESSIONAL STEEL AND ALUMINIUM HACKSAW ERGONOMIC HANDLE - HSS blade 12"

**GOMMOGRIP**  
**MUNDIAL** Impugnatura morbida bicomponente.  
 Soft bicomponent handle.



 0593.910     12"     700     6     8011578943622    **new**

**594** ARCHETTO PROFESSIONALE IMPUGNATURA IN LEGNO - Lama HSS 12"  
 PROFESSIONAL HACKSAW WOOD HANDLE - HSS blade 12"



 0594.010     12"     650     6     8011578921071

**595** ARCHETTO IMPUGNATURA IN LEGNO - Lama HSS 12"  
 HACKSAW WOOD HANDLE - HSS blade 12"



 0595.010     12"     374     6     8011578921101



**596** ARCHETTO IMPUGNATURA ERGONOMICA - Lama HSS 12"  
 HACKSAW ERGONOMIC HANDLE - HSS blade 12"



 0596.010     12"     410     6     8011578921132

**598** ARCHETTO PUK - finitura nichelata  
 PUK HACKSAW - nickel plated finish



 **0598.010**  6"  
 **92**  **12**  801157811000041

**598Z** SEGHETTO MINI IMPUGNATURA IN PLASTICA - puk  
 MINI HACKSAW PLASTIC HANDLE - puk





 **0598.910**  6"  
 **118**  **6**  8011578943646

**599A** LAMA PUK PER FERRO  
 PUK BLADE FOR IRON



prezzo per una lama  
 price for one blade

 **0599.110**  6"  
 **2**  **12**  8011578921224

**599B** LAMA PUK PER LEGNO  
 PUK BLADE FOR WOOD



prezzo per una lama  
 price for one blade

 **0599.210**  6"  
 **2**  **12**  8011578921255

**599D** LAMA HSS BIMETAL 12" TPI 24  
 HSS BIMETAL BLADE 12" TPI 24







prezzo per una lama  
 price for one blade

 **0599.410**  12"  
 **18**  **10**  8011578921286



**600** SCALPELLO PER MECCANICI FORGIATO - acciaio chrom-vanadium finitura cromata  
 CHISEL FOR MECHANIC - FORGED - chrom-vanadium steel chrome plated finish

DIN 6453

Icona	mm	mm	kg	Cont.	Barcode	Art. No.
	150 - 20	178	6	8011578921316	811578 000004	0600.015
	200 - 24	324	6	8011578921378	811578 000004	0600.020
	250 - 28	492	6	8011578921408	811578 000004	0600.025
	300 - 34	685	6	8011578963484	811578 000004	0600.030



new

**601** SCALPELLO PER MECCANICI CON PARAMANO - acciaio chrom-vanadium finitura cromata  
 CHISEL FOR MECHANIC WITH HAND PROTECTION - chrom-vanadium steel chrome plated finish

DIN 6453

Icona	mm	mm	kg	Cont.	Barcode	Art. No.
	250 - 28	582	2	8011578960988	811578 000004	0601.025
	300 - 34	770	2	8011578965686	811578 000004	0601.030





new

new

**601A** PARAMANO per art. 600  
 HAND PROTECTION - for art. 600

DIN 6453





Icona	mm	mm	kg	Cont.	Barcode	Art. No.
	118	per - for 250	82	2	8011578961008	0601.925
	120	per - for 300	84	2	8011578965709	0601.930

new

new



**609** SCALPELLO PER ELETTRICISTI - acciaio chrom-vanadium finitura cromata  
 CHISEL FOR ELECTRICIANS - chrom-vanadium steel chrome plated finish

Icona	mm	mm	kg	Cont.	Barcode	Art. No.
	8	200	80	12	8011578921460	0609.120
	10	200	128	12	8011578921491	0609.220
	10	250	158	12	8011578921521	0609.225
	10	300	192	12	8011578921552	0609.230



**610** PUNTA PER ELETTRICISTI - acciaio chrom-vanadium finitura cromata  
 CHISEL TIP FOR ELECTRICIANS - chrom-vanadium steel chrome plated finish

Icona	mm	mm	kg	Cont.	Barcode	Art. No.
	10	250	154	12	8011578921736	0610.225



## 612 SCALPELLO PER MECCANICI - acciaio chrom-vanadium finitura cromata

CHISEL FOR MECHANIC - chrom-vanadium steel chrome-plated finish

DIN 6453

Icona	●	←-L-→	👤	📦	Barcode
0612.013	9	125	50	12	8011578921859
0612.016	12	150	142	12	8011578921880



## 614 UNGHIETTA PER MECCANICI - acciaio chrom-vanadium finitura cromata

CHISEL CROSS FOR MECHANIC - chrom-vanadium steel chrome plated finish

DIN 6451

Icona	●	←-L-→	👤	📦	Barcode
0614.013	9	125	44	12	8011578921910
0614.016	12	150	128	12	8011578921941



## 615 PUNZONE PER MECCANICI - acciaio chrom-vanadium finitura cromata

DRIFT PUNCH FOR MECHANIC - chrom-vanadium steel chrome plated finish

DIN 5458

Icona	∅	●	←-L-→	👤	📦	Barcode
0615.100	1	9	125	58	12	8011578921972
0615.200	2	9	125	66	12	8011578922009
0615.300	3	9	125	68	12	8011578922030
0615.400	4	12	150	116	12	8011578922061
0615.500	5	12	150	106	12	8011578922092
0615.600	6	12	150	126	12	8011578922122



## 616 PUNZONE PER CENTRI PER MECCANICI - acciaio chrom-vanadium finitura cromata

CENTRE PUNCH FOR MECHANIC - chrom-vanadium steel chrome plated finish

DIN 7250

Icona	●	←-L-→	👤	📦	Barcode
0616.012	10	125	58	12	8011578922153
0616.015	13	150	114	12	8011578922184



## 616Z PUNZONE PER CENTRI AUTOMATICO - acciaio chrom-vanadium finitura cromata

AUTOMATIC CENTRE PUNCH - chrom-vanadium steel chrome plated finish

Icona	●	←-L-→	👤	📦	Barcode	
0616.910	4	125	60	6	8011578961022	<b>new</b>



## 617 CACCIASPINE PER MECCANICI - acciaio chrom-vanadium finitura cromata

PIN PUNCH FOR MECHANIC - chrom-vanadium steel chrome plated finish

DIN 6450

Icona	∅	●	←-L-→	👤	📦	Barcode
0617.020	2	30	110	40	12	8011578922214
0617.030	3	40	130	42	12	8011578922245
0617.040	4	50	145	76	12	8011578922276
0617.050	5	60	165	72	12	8011578922306
0617.060	6	65	180	138	12	8011578922337
0617.080	8	70	200	164	12	8011578922368



**617A** SERIE 6 CACCIASPINE - busta  
 SET 6 PIN PUNCHES - envelope

Contenuto-content:

0617.020	2	0617.050	5
0617.030	3	0617.060	6
0617.040	4	0617.080	8

      
**0617.110** 590 568 **6** 8011578617189



**620** SERIE 6 SCALPELLI E PUNZONI - busta  
 SET 6 CHISELS AND DRIFT PUNCHES - envelope

Contenuto-content:

0612.013	125	0615.200	2
0612.016	150	0615.400	4
0614.013	125	0616.012	125

      
**0620.010** 490 530 **6** 8011578620004



**622** SERIE 6 PUNZONI - busta  
 SET 6 DRIFT PUNCHES - envelope

Contenuto-content:

0615.100	1	0615.400	4
0615.200	2	0615.500	5
0615.300	3	0615.600	6

      
**0622.010** 476 600 **6** 8011578622008



**623** ESPOSITORE 63 PUNZONI-CACCIASPINE-SCALPELLI - metallo  
 DISPLAY STAND 63 DRIFT-PIN PUNCHES-CHISELS - metal

Contenuto-content:

0600.015	Nr. 3	0614.016	Nr. 3	0615.600	Nr. 3	0617.050	Nr. 3
0600.020	Nr. 3	0615.100	Nr. 3	0616.012	Nr. 3	0617.060	Nr. 3
0600.025	Nr. 3	0615.200	Nr. 3	0616.015	Nr. 3	0617.080	Nr. 3
0612.013	Nr. 3	0615.300	Nr. 3	0617.020	Nr. 3		
0612.016	Nr. 3	0615.400	Nr. 3	0617.030	Nr. 3		
0614.013	Nr. 3	0615.500	Nr. 3	0617.040	Nr. 3		

      
**0623.010** 440 x 210 x 60 14000 8011578623104  
**0623.210** vuoto - empty 1000 8011578960407



## 625 SCALPELLO PER MURATORE - acciaio finitura verniciata

CHISEL FOR MASON - steel varnished finish



DIN 7254

Icona	Ø	←-L→	Icona	Icona	Barcode
	16	250			80115781000004
0625.025	16	400	6	6	8011578922511
0625.030	16	300	6	6	8011578922542
0625.035	16	350	6	6	8011578922573
0625.040	16	400	6	6	8011578922603

## 626 PUNTA PER MURATORE - acciaio finitura verniciata

CHISEL TIP FOR MASON - steel varnished finish



DIN 7256

Icona	Ø	←-L→	Icona	Icona	Barcode
	16	250			80115781000004
0626.025	16	386	6	6	8011578922634
0626.030	16	300	6	6	8011578922665
0626.035	16	350	6	6	8011578922696
0626.040	16	400	6	6	8011578922726

## 628 SCALPELLO PER MURATORE RIAFFILABILE - acciaio finitura verniciata

CHISEL FOR MASON - RE-SHARPABLE - steel varnished finish



Icona	Ø	←-L→	Icona	Icona	Barcode
	16	300			80115781000004
0628.030	16	412	6	6	8011578922788
0628.035	16	350	6	6	8011578922818

## 629 PUNTA PER MURATORE RIAFFILABILE - acciaio finitura verniciata

CHISEL TIP FOR MASON - RE-SHARPABLE - steel varnished finish



Icona	Ø	←-L→	Icona	Icona	Barcode
	16	300			80115781000004
0629.030	16	400	6	6	8011578922849
0629.035	16	350	6	6	8011578922870

## 629A IMPUGNATURA PARAMANO per art. 625 - 626 - 628 - 629

HAND PROTECTION HANDLE for art. 625 - 626 - 628 - 629



Icona	Ø	Icona	Icona	Barcode
	16			80115781000004
0629.110	16	110	6	8011578922900

**630** SCALPELLO PER MURATORE RIAFFILABILE CON PARAMANO  
 CHISEL FOR MASON WITH HAND PROTECTION



Icona	Ø	l-L	Icona	Icona	Barcode
	16	300		566	2 8011578922931
	16	350		650	2 8011578922962

**631** PUNTA PER MURATORE RIAFFILABILE CON PARAMANO - acciaio finitura cromata  
 CHISEL TIP FOR MASON WITH HAND PROTECTION - RE-SHARPABLE - steel chrome finish



Icona	Ø	l-L	Icona	Icona	Barcode
	16	300		504	2 8011578922993
	16	350		586	2 8011578923020

**633** SCALPELLO PER MURATORE TIPO LARGO - acciaio finitura verniciata  
 CHISEL FOR MASON - WIDE - steel varnished finish



Icona	Icona	l-L	Icona	Icona	Barcode
		240		480	6 8011578923051
		240		506	6 8011578923082

**635** ESPOSITORE 48 SCALPELLI E PUNTE MURATORE - metallo  
 DISPLAY STAND 48 CHISEL AND CHISEL TIP FOR MASON - metal



Contenuto-content:

- 0625.030 Nr. 6
- 0625.035 Nr. 6
- 0626.030 Nr. 6
- 0626.035 Nr. 6
- 0628.030 Nr. 6
- 0628.035 Nr. 6
- 0629.030 Nr. 6
- 0629.035 Nr. 6

Icona	l-L	Icona	Barcode
	270 x 250 x 270		24500 8011578635008
	vuoto - empty		1000 8011578960421



**638** PIOMBO CILINDRICO - finitura verniciata  
 CYLINDRIC LEAD - varnished finish

🖨	Gr.	📦	📊
0638.010	100	12	8011578923112
0638.020	200	12	8011578923143
0638.030	300	6	8011578923174
0638.040	400	6	8011578923204
0638.050	500	6	8011578923235
0638.080	800	2	8011578923266

**638A** PIASTRA PER PIOMBI CILINDRICI  
 PLATE FOR CYLINDRIC LEAD

🖨	per/for	Gr.	📦	📊
0638.110	100		6	8011578923297
0638.120	200		6	8011578923327
0638.130	300		6	8011578923358
0638.140	400		6	8011578923389
0638.150	500		6	8011578923419
0638.180	800		6	8011578923440

**638Z** PIOMBO + FILO + PIASTRA - finitura verniciata  
 LEAD + ROPE + PLATE - varnished finish

🖨	Gr.	📦	📊	
0638.910	100	6	8011578968144	<b>new</b>
0638.920	200	6	8011578968168	<b>new</b>
0638.930	300	6	8011578968182	<b>new</b>
0638.940	400	6	8011578968205	<b>new</b>

**640** PIOMBO A PERA - finitura verniciata  
 LEAD - varnished finish

🖨	Gr.	📦	📊
0640.020	200	6	8011578923471
0640.030	300	6	8011578923501
0640.040	400	6	8011578923532
0640.050	500	6	8011578923563

**640A** PIASTRA PER PIOMBI A PERA  
 PLATE FOR LEAD

🖨	per/for	Gr.	📦	📊
0640.120	200		6	8011578923594
0640.130	300		6	8011578923624
0640.140	400		6	8011578923655
0640.150	500		6	8011578923662

**671** APRICASSE - finitura verniciata  
 LEVER - varnished finish

🖨	—L—	📦	📊
0671.010	400	628	6 8011578923686



**672** LEVACHIODO A COLLO DI CIGNO - finitura verniciata  
 WRECKING BARS - varnished finish

🖨	—L—	📦	📊
0672.010	600	1410	6 8011578923716



**680** FORBICI PROFESSIONALI MULTIUSO - lame acciaio inox con microdentatura - impugnatura isolata  
 SCISSORS - PROFESSIONAL MULTI-USE - stainless steel anti-slipping blades - insulated handle



 **0680.010**  145  **80**  **12**  8011578923747

**680.900** ESPOSITORE IN CARTONE 24 FORBICI  
 CARTON DESK DISPLAY 24 SCISSORS

Contenuto-content:  
 0680.010 Nr. 24



 **0680.900**  260 x 260 x 260  2620  8011578947767

**683** FORBICI PER ELETTRICISTI - bicomponente inox  
 SCISSORS FOR ELECTRICIANS - bicomponent inox



 **0683.010**  145  **98**  **12**  8011578934002

**683.900** ESPOSITORE IN CARTONE 24 FORBICI  
 CARTON DESK DISPLAY 24 SCISSORS

Contenuto-content:  
 0683.010 Nr. 24



 **0683.900**  260 x 260 x 260  2600  8011578947804

**686A** FORBICI ELETTRICISTI RETTE  
 SCISSORS FOR ELECTRICIANS - STRAIGHT



 **0686.110**  145  **90**  **12**  8011578923921

**686B** FORBICI ELETTRICISTI CURVE  
 SCISSORS FOR ELECTRICIANS - BENT



 **0686.210**  145  **90**  **12**  8011578923952

**689**

**FORBICI ELETTRICISTI - inox**  
**SCISSORS FOR ELECTRICIANS - stainless**



      
**0689.010** 140 67 **12** 8011578943882

**689.900**

**ESPOSITORE 24 FORBICI**  
**DISPLAY 24 SCISSORS**



Contenuto-content:  
 0689.010 Nr. 24

      
**0689.900** 260x260x260 2300 8011578947828

**700**

**TRONCHESE TAGLIACAVI IN RAME**  
**CUTTER PLIERS FOR COPPER**









      
**0700.010** 200 303 **6** 8011578943929

**702**

**TAGLIACAVI IN RAME - acciaio speciale alta resistenza al taglio - finitura verniciata - impugnatura isolata**  
**CUTTER PLIERS FOR COPPER CABLE - special steel high cut resistant - varnished finish - insulated handle**



       
**0702.010** 450 27 150 x 2 982 **1** 8011578963460

**new**

**705**







**MOLLA**  
**SPRING**



      
**0705.045** 45 5 **12** 8011578924676  
**0705.060** 60 7 **12** 8011578924706  
**0705.065** 65 7 **12** 8011578924737  
**0705.070** 70 8 **12** 8011578924768  
**0705.075** 75 8 **12** 8011578924799

**710** PINZA UNIVERSALE ISOLATA 1000 volt VDE - acciaio chrom-vanadium finitura cromata  
 COMBINATION PLIERS - INSULATED 1000 volt VDE - chrom-vanadium steel chrome plated finish







						
0710.018	180	5,8 x 10	36,5	300	6	8011578933005
0710.020	200	7 x 10,5	39,5	360	6	8011578933029

**GOMMOGRIP MUNDIAL** Impugnatura morbida bicomponente.  
 Soft bicomponent handle.

**712** PINZA BECCHI MEZZOTONDI ISOLATA 1000 volt VDE - acciaio chrom-vanadium finitura cromata  
 HALF NOSE PLIERS - INSULATED 1000 volt VDE - chrom-vanadium steel chrome plated finish



						
0712.016	160	3 x 2,5	61	176	6	8011578933043
0712.020	200	3 x 2,5	77	202	6	8011578933067



**714** PINZA BECCHI CURVI MEZZOTONDI ISOLATA 1000 volt VDE - acciaio chrom-vanadium finitura cromata  
 BENT HALF NOSE PLIERS - INSULATED 1000 volt VDE - chrom-vanadium steel chrome plated finish



						
0714.016	160	3 x 2,5	61	176	6	8011578933081
0714.020	200	3 x 2,5	77	202	6	8011578933104



**716** TRONCHESE TAGLIO DIAGONALE ISOLATA 1000 volt VDE - acciaio chrom-vanadium finitura cromata  
 CUTTER DIAGONAL CUTTING - INSULATED 1000 volt VDE - chrom-vanadium steel chrome plated finish

					
0716.016	160	20	212	6	8011578933128



**722** PINZA SPELAFILI ISOLATA 1000 volt VDE - acciaio chrom-vanadium finitura cromata  
 WIRE STRIPPING PLIERS - INSULATED 1000 volt VDE - chrom-vanadium steel chrome plated finish

				
0722.010	160	178	6	8011578933142



## 728 ESPOSITORE 36 PINZE E TRONCHESI ISOLATE 1000 volt VDE DISPALY 36 PLIERS AND CUTTERS - INSULATED 1000 volt VDE

Contenuto

0710.018 Nr. 6  
 0710.020 Nr. 6  
 0712.016 Nr. 6  
 0712.020 Nr. 6  
 0714.020 Nr. 6  
 0716.016 Nr. 6

**0728.010** 475 x 215 x 180

12600



8011578728007



## 730 ESPOSITORE GIRAVITI E PINZE ISOLATE 1000 volt VDE DISPLAY INSULATED SCREWDRIVERS AND PLIERS 1000 volt VDE

 DVE 60900

Contenuto-content:

0090.258 2,5x0,4x80 Nr. 9  
 0090.310 3,0x0,5x100 Nr. 9  
 0090.410 4,0x0,8x100 Nr. 8  
 0090.512 5,5x1,0x125 Nr. 8  
 0090.615 6,5x1,2x150 Nr. 7  
 0090.817 8,0x1,6x175 Nr. 6  
 0092.007 PH0x75 Nr. 9  
 0092.110 PH1x100 Nr. 8  
 0092.210 PH2x100 Nr. 7  
 0092.315 PH3x150 Nr. 6  
 0093.007 PZ0x75 Nr. 9  
 0093.110 PZ1x100 Nr. 8  
 0093.210 PZ2x100 Nr. 7  
 0710.018 Nr. 6  
 0710.020 Nr. 6  
 0712.016 Nr. 6  
 0712.020 Nr. 6  
 0714.020 Nr. 6  
 0716.016 Nr. 6

**0730.010** 475 x 215 x 600

29250



8011578730000



## 730.900 ESPOSITORE CARTONE 18 PINZE E TRONCHESI ISOLATE 1000 volt VDE CARTON DESK DISPLAY 18 PLIERS AND CUTTER - INSULATED 1000 volt VDE

Contenuto-content:

0710.018 Nr. 12  
 0716.016 Nr. 3  
 0712.016 Nr. 3

**0730.900** 260 x 260 x 260

4900









8011578947842



**739** SPELAFILI AUTOMATICO FRONTALE  
 FRONT AUTOMATIC WIRE STRIPPING PLIER



       
**0739.010** 0,25 ÷ 6,0 mm<sup>2</sup> 175 210 **2** 8011578963941 **new**



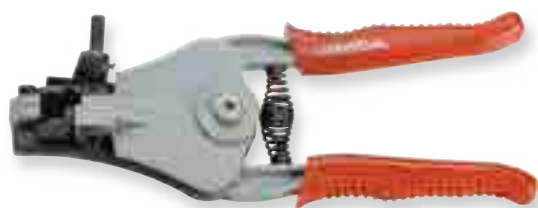



**740** SPELAFILI AUTOMATICO  
 AUTOMATIC WIRE STRIPPING PLIER



      
**0740.010** 200 210 **2** 8011578943608







**741** TAGLIACAVI A CREMAGLIERA AUTOMATICO per cavi in rame-alluminio  
 RATCHETING CABLES CUTTER for copper-aluminium cable



       
**0741.020** mm 36 / 300 mm<sup>2</sup> 260 670 **1** 8011578961046 **new**  
**0741.040** mm 60 / 500 mm<sup>2</sup> 320 858 **1** 8011578961060 **new**

**741Z** TAGLIACAVI A CREMAGLIERA AUTOMATICO per cavi in rame-alluminio  
 RATCHETING CABLES CUTTER for copper-aluminium cable



       
**0741.920** mm 32 / 240 mm<sup>2</sup> 250 670 **1** 8011578970420 **new**  
**0741.940** mm 52 / 400 mm<sup>2</sup> 270 858 **1** 8011578970444 **new**

**750** PINZA CAPICORDA ISOLATI  
 CRIMPING PLIER FOR INSULATED TERMINAL



0,5-1,5 1,5-2,5 4,0-6,0 mm<sup>2</sup> - AVG 20-10

      
**0750.010** 220 578 2 8011578963965 **new**

**751** PINZA CAPICORDA NON ISOLATI  
 CRIMPING PLIER FOR NON-INSULATED TERMINAL



0,5-1,0 1,5-2,5 4,0-10,0 mm<sup>2</sup> - AWG 20-7

      
**0751.010** 220 578 2 8011578963989 **new**

**752** PINZA CAPICORDA APERTI NON ISOLATI  
 CRIMPING PLIER FOR NON-INSULATED TAB AND RECEPTACLES



0,5-1,0 1,5-2,5 4,0-6,0 mm<sup>2</sup> - AWG 20-10

      
**0752.010** 220 578 2 8011578964009 **new**

**756** PINZA CAPICORDA DATI-TELEFONIA  
 MODULAR PLUG CRIMPS PLIER-TELECOM



RJ10 (4) 7,65 mm  
 RJ11/12 (6) 9,65 mm  
 RJ45 (8) 11,68 mm

      
**0756.010** 225 510 2 8011578964023 **new**



**769** TAGLIATUBI MINI  
 MINI TUBE CUTTER

	∅			
0769.015	15	259	2	8011578942724
0769.022	22	274	2	8011578942748



**770** TAGLIATUBI MINI RAME E LEGHE LEGGERE mm 22 - 7/8"  
 MINI TUBING CUTTER mm 22 - 7/8"

	∅			
0770.022	22 - 7/8"	99	2	8011578934804



**772** TAGLIATUBI RAME E LEGHE LEGGERE mm 32 - 1 1/4"  
 TUBING CUTTER mm 32 - 1 1/4"

	∅			
0772.032	32 - 1 1/4"	278	2	8011578934828



**773** TAGLIATUBI TELESCOPICO 4 RULLI mm 42  
 TELESCOPIC TUBING CUTTER WITH 4 ROLLERS mm 42

- 4 RULLI  
 - 4 ROLLERS

	∅			
0773.010	42	640	2	8011578967222



new

**774** TAGLIATUBI TELESCOPICO RAME E LEGHE LEGGERE mm 32 - 1 1/4"  
 TELESCOPIC TUBING CUTTER mm 32 - 1 1/4"

	∅			
0774.032	32 - 1 1/4"	272	2	8011578934842



**775** LAMA per 770 - 772 - 774  
 SPARE BLADE for 770 - 772 - 774

	L-L			
0775.110	18x3 rame - copper	3	2	8011578934866
0775.210	18x3 inox - stainless steel	3	2	8011578934880





**776** TAGLIATUBI TELESCOPICO RAPIDO RAME E LEGHE LEGGERE mm 63 - 2 1/2"  
 ACTION TELESCOPIC TUBING CUTTER mm 63 - 2 1/2"



				
0776.063	63 - 2 1/2"	540	2	8011578934903

**776...** LAMA per 776  
 SPARE BLADE for 776

				
0776.110	18x3 rame - copper	3	2	8011578934927
0776.210	18x3 inox - stainless steel	3	2	8011578934941
0776.310	18x3 plastica - plastic	6	2	8011578934965



**777** TAGLIATUBI TELESCOPICO RAPIDO PLASTICA mm 127 - 5"  
 ACTION TELESCOPIC TUBING CUTTER mm 127 - 5"



				
0777.127	127 - 5"	2000	1	8011578934989

**777...** LAMA per 777  
 SPARE BLADE for 777

				
0777.210	42x11 plastica - plastic	25	2	8011578935009







**782** TAGLIATUBI PER ACCIAIO 2"  
 STEEL PIPE CUTTER 2"



				
0782.002	2"	2500	2	8011578935023

**782...** LAMA per 782  
 SPARE BLADE for 782

				
0782.110	31x19 acciaio - steel	25	2	8011578935047
0782.210	31x19 inox - stainless steel	23	2	8011578935061



**786** TAGLIATUBI A CRICCHETTO PER PLASTICA mm 42  
 PVC QUICK RELEASE PIPE CUTTER mm 42

      
 0786.042 42 767 2 8011578940126



**790** TAGLIATUBI CRICCHETTO PER PLASTICA mm 42 - 1 5/8"  
 PVC PIPE CUTTER mm 42 - 1 5/8"

      
 0790.042 42 - 1 5/8" 318 2 8011578935085



**792** TAGLIATUBI PLASTICA AUTOMATICO mm 42 - 1 5/8"  
 AUTO PVC PIPE CUTTER mm 42 - 1 5/8"

      
 0792.042 42 - 1 5/8" 536 2 8011578935108



**792A** LAMA per 792.042  
 SPARE BLADE for 792.042

     
 792.142 74 2 8011578943028



**794** TAGLIATUBI PLASTICA mm 63 - 2 1/2"  
 PVC PIPE CUTTER mm 63 - 2 1/2"

      
 0794.063 63 - 2 1/2" 1074 1 8011578935122



**794A** LAMA per 794.063  
 BLADES for 794.063

     
 0794.163 170 2 8011578943042



**795** SBAVATUBI  
 REAMER

 0795.010

  210 2  80115781000004 8011578942601

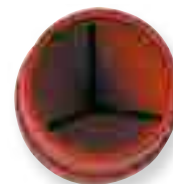

**796.100** CHIAVE SOTTOLAVABO REVERSIBILE  
 REVERSIBLE BASIN WRENCH

 0796.100

←-L-→  
 350

  503 2  80115781000004 8011578942700



**796.300** CHIAVE SOTTOLAVABO RUBINETTO  
 BASIN WRENCH

 0796.300

←-L-→  
 310

  474 2  80115781000004 8011578935146



**797** CHIAVE SOTTOLAVABO RUBINETTO TELESCOPICO  
 TELESCOPIC BASIN WRENCH

 0797.300

←-L-→  
 290

  761 2  80115781000004 8011578935160



**798** PINZA PER SIFONI  
 SYPHONE PLIERS

 0798.240

←-L-→  
 230

  255 2  80115781000004 8011578935184



**799** PIEGATUBI mm. 6-8-10  
 TUBE BENDER mm. 6-8-10

 0799.010

←-L-→  
 275

  427 1  80115781000004 8011578942625



**803** SERIE 7 MATRICI E CRICCHETTO CURVATUBI PER RAME E MULTISTRATO  
 SET 7 BEND FORM AND RATCHET FOR COPPER ISOLATED TUBE

per tubi - for tube  
 10-12-14-16-18-20-22

  6-22 mm   2000 **1**  8011578 000004 **new**



**807** UTENSILE PER COLLETTI TUBI RAME-OTTONE-ALLUMINIO  
 TOOL FOR FLARING TUBE COPPER-BRASS-ALUMINIUM

per tubi - for tube  
 3/16 - 5/8

  5-16 mm   740 **2**  8011578 000004 **new**



**815** CHIAVE PER PILETTE  
 PLUMBERS BASIN LEVEL

  42-56 mm   315 **2**  8011578 000004 **new**



**830** CHIAVE 4 APERTURE A CROCE  
 CROSS KEY WRENCH

  54  **2**  8011578 000004 **new**



## 832 RASCHIETTO TELESCOPICO

### TELESCOPIC DEBURRING TOOL



 0832.010
  30
  2
  801157811000041
 **new**

## 833 LAMA HSS per art. 832

### HSS BLADE for art. 832

prezzo per una lama  
price for one blade



 0833.010
  3
  10
  801157811000041
 **new**

## 840 CRICCHETTO 1/2" FEMMINA

### RATCHET 1/2" FEMALE



 0840.010
  270
  526
  2
  8011578964047
 **new**

## 841 CRICCHETTO + CHIAVE GRADINI

### RATCHET + WRENCH STEP



mm 9,6 - 11,6 - 12,6 - 16,4 - 21,0

 0841.010
  654
  1
  8011578964061
 **new**

## 842 CHIAVE GRADINI RADIATORE 1/2"

### WRENCH STEP 1/2"



mm 9,6 - 11,6 - 12,6 - 16,4 - 21,0

 0842.010
  90
  128
  2
  8011578964085
 **new**

## 843 RACCORDO 1/2"

### ADAPTER FROM 1/2"



 0843.010
  35
  42
  2
  8011578964108
 **new**

## 847 KIT RIPARAZIONE RUBINETTI

### SET TOP RESEATER



mm 10 - 12 - 13 - 14 - 15 - 16





 0847.010
  180
  1
  8011578964122
 **new**

**1020**

**CHIAVE A FORCHETTA - acciaio chrom-vanadium finitura cromata teste lucide**  
**DOUBLE ENDED OPEN WRENCH - chrom-vanadium steel chrome plated finish polish heads**



DIN 3110 ISO 10102

			Sp.			
<b>1020.067</b>	<b>6-7</b>	122 15 17	3,6	20	<b>12</b>	8011578924850
<b>1020.089</b>	<b>8-9</b>	140 20 22	4,0	33	<b>12</b>	8011578924881
<b>1020.101</b>	<b>10-11</b>	157 24 26	4,4	48	<b>12</b>	8011578924911
<b>1020.123</b>	<b>12-13</b>	172 28 30	5,0	65	<b>12</b>	8011578924942
<b>1020.145</b>	<b>14-15</b>	190 32 34	5,4	85	<b>12</b>	8011578924973
<b>1020.167</b>	<b>16-17</b>	205 36 38	5,8	120	<b>12</b>	8011578925000
<b>1020.189</b>	<b>18-19</b>	222 39 41	6,3	162	<b>6</b>	8011578925031
<b>1020.202</b>	<b>20-22</b>	236 43 47	7,0	214	<b>6</b>	8011578925062
<b>1020.213</b>	<b>21-23</b>	250 45 49	7,6	231	<b>6</b>	8011578925093
<b>1020.246</b>	<b>24-26</b>	260 52 56	8,0	308	<b>6</b>	8011578925123
<b>1020.247</b>	<b>24-27</b>	260 52 58	8,0	316	<b>6</b>	8011578925154
<b>1020.258</b>	<b>25-28</b>	280 52 58	8,0	340	<b>6</b>	8011578925185
<b>1020.302</b>	<b>30-32</b>	310 59 64	8,5	429	<b>6</b>	8011578925215
<b>1020.326</b>	<b>32-36</b>	310 64 72	8,5	500	<b>2</b>	8011578960483
<b>1020.361</b>	<b>36-41</b>	355 64 79	8,5	790	<b>2</b>	8011578942687
<b>1020.416</b>	<b>41-46</b>	420 79 88	13,5	1192	<b>2</b>	8011578943523
<b>1020.465</b>	<b>46-50</b>	475 88 95	15	1600	<b>2</b>	8011578943547

**1021**

**SERIE CHIAVI A FORCHETTA - scatola cartone**  
**SET DOUBLE ENDED OPEN WRENCHES - box**

Contenuto - content:

- 1020.067 6-7
- 1020.089 8-9
- 1020.101 10-11
- 1020.123 12-13
- 1020.145 14-15
- 1020.167 16-17

sette - set  
**6**

	Pz.		
<b>1021.060</b>	<b>6</b>	404	8011578021030



Contenuto - content:

- 1020.067 6-7
- 1020.089 8-9
- 1020.101 10-11
- 1020.123 12-13
- 1020.145 14-15
- 1020.167 16-17
- 1020.189 18-19
- 1020.202 20-22

sette - set  
**8**

	Pz.		
<b>1021.080</b>	<b>8</b>	770	8011578021078



**1021**
**SERIE CHIAVI A FORCHETTA - scatola cartone**  
 SET DOUBLE ENDED OPEN WRENCHES - box

Contenuto - content:

 1020.067 6-7  
 1020.089 8-9  
 1020.101 10-11  
 1020.123 12-13  
 1020.145 14-15  
 1020.167 16-17  
 1020.189 18-19  
 1020.202 20-22  
 1020.213 21-23  
 1020.247 24-27  
 1020.258 25-28  
 1020.302 30-32

 serie - set  
**12**
  
**1021.120**

 Pz.  
**12**
  
 2200

  
 8011578021092
**1022**
**SERIE CHIAVI A FORCHETTA - busta tela avvolgibile**  
 SET DOUBLE ENDED OPEN WRENCHES - envelope canvas roller blind

Contenuto - content:

 1020.067 6-7            1020.145 14-15  
 1020.089 8-9            1020.167 16-17  
 1020.101 10-11        1020.189 18-19  
 1020.123 12-13        1020.202 20-22

 serie - set  
**8**
  
**1022.080**

 Pz.  
**8**
  
 830

  
 8011578022082

Contenuto - content:

 1020.067 6-7            1020.189 18-19  
 1020.089 8-9            1020.202 20-22  
 1020.101 10-11        1020.213 21-23  
 1020.123 12-13        1020.247 24-27  
 1020.145 14-15        1020.258 25-28  
 1020.167 16-17        1020.302 30-32

 serie - set  
**12**
  
**1022.120**

 Pz.  
**12**
  
 2300

  
 8011578022129

**1022.208**  
**1022.212**
**8**  
**12**

 8011578968229  
 8011578968243

 Busta vuota per 8 chiavi a forchetta - Empty envelope for 8 wrenches  
 Busta vuota per 12 chiavi a forchetta - Empty envelope for 12 wrenches
**1023**
**SERIE 8 CHIAVI A FORCHETTA - cartone**  
 SET 8 DOUBLE ENDED OPEN WRENCHES - box

Contenuto - content:

 1020.067 6-7  
 1020.089 8-9  
 1020.101 10-11  
 1020.123 12-13  
 1020.145 14-15  
 1020.167 16-17  
 1020.189 18-19  
 1020.202 20-22

 serie - set  
**8**
  
**1023.080**

 Pz.  
**8**
  
 928

  
 8011578023058

**1025**

**CHIAVE POLIGONALE - acciaio chrom-vanadium finitura cromata teste lucide**  
**OFFSET DOUBLE RING WRENCH - chrom-vanadium steel chrome plated finish polish heads**

DIN 838 ISO 10104



Model	Sp. (mm)	Sp. (in)	Sp. (mm)	Sp. (in)	Sp. (mm)	Sp. (in)	Sp. (mm)	Sp. (in)	Sp. (mm)	Sp. (in)
1025.067	6-7	173	10,5	12,5	5-6	52	12	8011578925451		
1025.089	8-9	185	13,0	15,0	5,5-6,5	58	12	8011578925482		
1025.101	10-11	200	16,0	17,5	7,5-9	86	12	8011578925512		
1025.123	12-13	215	19,0	21,0	8,5-9,5	112	12	8011578925543		
1025.145	14-15	230	23,0	24,0	9,5-10	126	12	8011578925574		
1025.167	16-17	245	25,0	26,0	10-12	184	12	8011578925604		
1025.189	18-19	265	23,0	24,0	12-12,5	224	6	8011578925635		
1025.202	20-22	292	31,0	34,0	13-13,5	316	6	8011578925666		
1025.213	21-23	320	31,5	35,5	13-13,5	330	6	8011578925697		
1025.246	24-26	330	36,5	39,0	13,5-14	422	6	8011578925727		
1025.247	24-27	330	36,5	40,5	13,5-14,5	416	6	8011578925758		
1025.258	25-28	340	39,0	43,0	14-16	510	6	8011578925789		
1025.302	30-32	370	45,0	47,0	15-17	602	6	8011578925819		
1025.364	36-41	465	54,0	60,0	18-18	1289	6	8011578969707		

new

**1026**

**SERIE CHIAVI POLIGONALI - scatola cartone**  
**SET OFFSET-DOUBLE RING WRENCHES - box**

Contenuto - content:

- 1025.067 6-7
- 1025.089 8-9
- 1025.101 10-11
- 1025.123 12-13
- 1025.145 14-15
- 1025.167 16-17

sette - set  
**6**

Model	Pz.	Pz.	Pz.
1026.060	6	666	8011578026028



Contenuto - content:

- 1025.067 6-7
- 1025.089 8-9
- 1025.101 10-11
- 1025.123 12-13
- 1025.145 14-15
- 1025.167 16-17
- 1025.189 18-19
- 1025.202 20-22

sette - set  
**8**

Model	Pz.	Pz.	Pz.
1026.080	8	1182	8011578026035



Contenuto - content:

- 1025.067 6-7
- 1025.089 8-9
- 1025.101 10-11
- 1025.123 12-13
- 1025.145 14-15
- 1025.167 16-17
- 1025.189 18-19
- 1025.202 20-22
- 1025.213 21-23
- 1025.247 24-27
- 1025.258 25-28
- 1025.302 30-32

sette - set  
**12**

Model	Pz.	Pz.	Pz.
1026.120	12	3100	8011578026073







**1031**

**SERIE CHIAVI COMBinate - scatola cartone**  
**SET COMBINATION WRENCHES - box**

Contenuto - content:

1030.060 6-6	1030.120 12-12	1030.180 18-18
1030.070 7-7	1030.130 13-13	1030.190 19-19
1030.080 8-8	1030.140 14-14	1030.200 20-20
1030.090 9-9	1030.150 15-15	1030.210 21-21
1030.100 10-10	1030.160 16-16	1030.220 22-22
1030.110 11-11	1030.170 17-17	

serie-set  
**17**

	Pz.		
<b>1031.170</b>	<b>17</b>	1738	8011578031053



Contenuto - content:

1030.060 6-6	1030.130 13-13	1030.200 20-20
1030.070 7-7	1030.140 14-14	1030.210 21-21
1030.080 8-8	1030.150 15-15	1030.220 22-22
1030.090 9-9	1030.160 16-16	1030.240 24-24
1030.100 10-10	1030.170 17-17	1030.270 27-27
1030.110 11-11	1030.180 18-18	1030.300 30-30
1030.120 12-12	1030.190 19-19	1030.320 32-32

serie-set  
**21**

	Pz.		
<b>1031.210</b>	<b>21</b>	3600	8011578031213



Contenuto - content:

1030.060 6-6	1030.150 15-15	1030.240 24-24
1030.070 7-7	1030.160 16-16	1030.250 25-25
1030.080 8-8	1030.170 17-17	1030.260 26-26
1030.090 9-9	1030.180 18-18	1030.270 27-27
1030.100 10-10	1030.190 19-19	1030.280 28-28
1030.110 11-11	1030.200 20-20	1030.300 30-30
1030.120 12-12	1030.210 21-21	1030.320 32-32
1030.130 13-13	1030.220 22-22	
1030.140 14-14	1030.230 23-23	

serie-set  
**25**

	Pz.		
<b>1031.250</b>	<b>25</b>	5000	8011578031237



**1032**

**SERIE CHIAVI COMBinate - busta tela avvolgibile**  
**SET COMBINATION WRENCHES - envelope canvas roller blind**

Contenuto - content:

1030.080 8-8	1030.170 17-17
1030.090 9-9	1030.190 19-19
1030.100 10-10	
1030.110 11-11	
1030.130 13-13	
1030.140 14-14	

serie-set  
**8**

	Pz.		
<b>1032.080</b>	<b>8</b>	703	8011578032081



Contenuto - content:

1030.060 6-6	1030.170 17-17
1030.070 7-7	1030.190 19-19
1030.080 8-8	1030.220 22-22
1030.090 9-9	
1030.100 10-10	
1030.110 11-11	
1030.120 12-12	
1030.130 13-13	
1030.140 14-14	

serie-set  
**12**

	Pz.		
<b>1032.120</b>	<b>12</b>	1085	8011578032128



<b>1032.208</b>	<b>8</b>	8011578968281
<b>1032.212</b>	<b>12</b>	8011578968304

Busta vuota per 8 chiavi combinate - Empty envelope for 8 wrenches  
 Busta vuota per 12 chiavi combinate - Empty envelope for 12 wrenches

**1033** SERIE CHIAVI COMBINATE - scatola cartone  
 SET COMBINATION WRENCHES - box

Contenuto - content:

1030.080 8-8	1030.130 13-13
1030.090 9-9	1030.140 14-14
1030.100 10-10	1030.170 17-17
1030.110 11-11	1030.190 19-19

serie-set  
**8**

	Pz.		
<b>1033.080</b>	<b>8</b>	816	8011578033095



Contenuto - content:







1030.060 6-6	1030.120 12-12
1030.070 7-7	1030.130 13-13
1030.080 8-8	1030.140 14-14
1030.090 9-9	1030.170 17-17
1030.100 10-10	1030.190 19-19
1030.110 11-11	1030.220 22-22

serie-set  
**12**

	Pz.		
<b>1033.120</b>	<b>12</b>	1200	8011578033057



**1035** CHIAVE COMBINATA in POLLICI - acciaio chrom-vanadium finitura cromata  
 COMBINATION WRENCH in INCH - chrom-vanadium steel chrome plated finish

					
<b>1035.005</b>	1/4"	102	18	<b>2</b>	8011578964146
<b>1035.008</b>	5/16"	125	26	<b>2</b>	8011578964160
<b>1035.010</b>	3/8"	133	30	<b>2</b>	8011578964184
<b>1035.020</b>	7/16"	150	50	<b>2</b>	8011578964207
<b>1035.030</b>	1/2"	170	76	<b>2</b>	8011578964221
<b>1035.040</b>	9/16"	180	80	<b>2</b>	8011578964245
<b>1035.050</b>	5/8"	205	114	<b>2</b>	8011578964269
<b>1035.070</b>	11/16"	205	130	<b>2</b>	8011578964283
<b>1035.080</b>	3/4"	230	164	<b>2</b>	8011578964306
<b>1035.100</b>	13/16"	245	200	<b>2</b>	8011578964320
<b>1035.110</b>	7/8"	255	234	<b>2</b>	8011578964344
<b>1035.120</b>	15/16"	280	302	<b>2</b>	8011578964368
<b>1035.130</b>	1"	285	246	<b>2</b>	8011578964382
<b>1035.140</b>	1.1/16"	305	404	<b>2</b>	8011578964405
<b>1035.150</b>	1.1/8"	315	394	<b>2</b>	8011578964429
<b>1035.170</b>	1.1/4"	360	598	<b>2</b>	8011578964443



POLLICI  
INCH

new  
new  
new  
new  
new  
new  
new  
new  
new  
new  
new  
new  
new  
new  
new

**1035** SERIE CHIAVI COMBINATE in POLLICI - scatola cartone  
 SET COMBINATION WRENCHES in INCH - box

Contenuto - content:

1035.005	1035.008	1035.010	1035.020	1035.030
1035.040	1035.050	1035.070	1035.080	

serie-set  
**9**

	Pz.		<b>new</b>
<b>1035.909</b>	<b>9</b>	8011578970369	



Contenuto - content:

1035.005	1035.008	1035.010	1035.020	1035.030	1035.040	1035.050
1035.070	1035.080	1035.100	1035.110	1035.120	1035.130	

serie-set  
**13**

	Pz.		<b>new</b>
<b>1035.913</b>	<b>13</b>	8011578964481	



**1035** SERIE CHIAVI COMBinate in POLLICI - scatola cartone  
 SET COMBINATION WRENCHES in INCH - box

serie - set  
**16**

Contenuto - content:

1035.005 1035.008 1035.010 1035.020 1035.030 1035.040 1035.050 1035.070  
 1035.080 1035.100 1035.110 1035.120 1035.130 1035.140 1035.150 1035.170



Pz.



**1035.916**

**16**

8011578964504

**new**

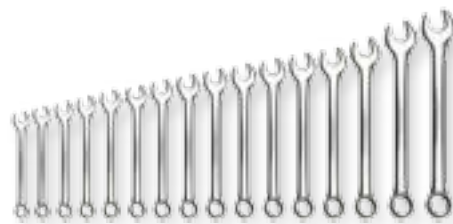

**1038** CHIAVE COMBINATA LUNGHISSIMA - acciaio chrom-vanadium finitura cromata teste lucide  
 COMBINATION WRENCH EXTRA LONG - chrom-vanadium steel chrome plated finish polish heads



DIN 3113 ISO 7738



Sp.†



Model	Size	Length	Width	Sp.†	Qty	Barcode	Status
1038.080	8-8	170	13,7	18	4-6	2 8011578968328	<b>new</b>
1038.100	10-10	190	16	20	4,2-7	2 8011578968342	<b>new</b>
1038.110	11-11	200	18	24	5-9	2 8011578968366	<b>new</b>
1038.120	12-12	215	19	27	5-9	2 8011578968380	<b>new</b>
1038.130	13-13	225	20	28	5-9	2 8011578968403	<b>new</b>
1038.140	14-14	240	22	30	5-9	2 8011578968427	<b>new</b>
1038.150	15-15	250	23	31	5,5-10	2 8011578968441	<b>new</b>
1038.170	17-17	290	26	35	6,5-10,5	2 8011578968465	<b>new</b>
1038.190	19-19	320	29	39	7-11	2 8011578968489	<b>new</b>

**1039** SERIE CHIAVI COMBinate LUNGHISSIME - scatola cartone  
 SET COMBINATION WRENCHES EXTRA LONG - box

serie - set  
**5**

Contenuto - content:

1038.080 8-8 1038.130 13-13 1038.190 19-19  
 1038.100 10-10 1038.170 17-17



Pz.



**1039.050**

**5**

8011578968502

**new**



serie - set  
**9**

Contenuto - content:

1038.080 8-8 1038.120 12-12 1038.150 15-15  
 1038.100 10-10 1038.130 13-13 1038.170 17-17  
 1038.110 11-11 1038.140 14-14 1038.190 19-19



Pz.



**1039.090**

**9**

8011578968526

**new**



**1039** SERIE CHIAVI COMBinate LUNGHISSIME  
 SET COMBINATION WRENCHES EXTRA LONG

serie - set  
**5**

Contenuto - content:

1038.080 8-8 1038.130 13-13 1038.190 19-19  
 1038.100 10-10 1038.170 17-17



Pz.



**1039.905**

**5**

8011578968540

**new**



# 1040

## CHIAVE COMBINATA DOPPIA CURVA 75° (controgomito) - acciaio chrom-vanadium finitura cromata COMBINATION WRENCH OFFSET 75° - chrom-vanadium steel chrome plated finish

DIN 3113 ISO 7738



Icona	Sp.†	Sp.†	Sp.†	Sp.†	Sp.†	Sp.†	Sp.†	Sp.†	Sp.†	Sp.†	Sp.†	Sp.†	Sp.†	Sp.†	Sp.†
1040.080	8-8	124	13,7	18	4-6	28	6	8011578968649	new						
1040.100	10-10	148	16	20	4,2-7	40	6	8011578968663	new						
1040.110	11-11	157	18	24	5-9	50	6	8011578968687	new						
1040.120	12-12	172	19	27	5-9	60	6	8011578968700	new						
1040.130	13-13	181	20	28	5-9	80	6	8011578968724	new						
1040.140	14-14	194	22	30	5-9	86	6	8011578968748	new						
1040.150	15-15	210	23	31	5,5-10	110	6	8011578968762	new						
1040.170	17-17	232	26	35	6,5-10,5	153	6	8011578968786	new						
1040.190	19-19	258	29	39	7-11	202	6	8011578968809	new						
1040.220	22-22	286	33	40	8-13	276	6	8011578968823	new						
1040.240	24-24	316	36	48	9-13	351	6	8011578968847	new						
1040.270	27-27	352	40	54	10-14	460	6	8011578968861	new						
1040.300	30-30	389	45	61	11-16	600	6	8011578968885	new						
1040.320	32-32	412	45	61	11-16	690	6	8011578968908	new						



- per operare in profondità  
- for operating in recess

Tipo pesante - Heavy duty:

1040.460	46-46	500	2400	1	8011578968564	new
1040.500	50-50	540	2800	1	8011578968588	new
1040.550	55-55	610	3200	1	8011578968601	new
1040.600	60-60	660	4000	1	8011578968625	new
1040.700	70-70	810	6460	1	8011578970468	new

# 1041

## SERIE CHIAVI COMBINATE DOPPIA CURVA 75° - scatola cartone SET COMBINATION WRENCHES OFFSET 75° - box

Contenuto - content:

1040.080 1040.110 1040.140 1040.170  
1040.100 1040.130 1040.150 1040.190

serie - set  
8

Icona	Pz.	Sp.†	Sp.†	Sp.†	Sp.†	Sp.†	Sp.†	Sp.†	Sp.†
1041.080	8	750	8011578968922	new					

Contenuto - content:

1040.080 1040.110 1040.130 1040.150 1040.190 1040.240  
1040.100 1040.120 1040.140 1040.170 1040.220 1040.270

serie - set  
12

Icona	Pz.	Sp.†	Sp.†	Sp.†	Sp.†	Sp.†	Sp.†	Sp.†	Sp.†
1041.120	12	1900	8011578968946	new					

Contenuto - content:

1040.080 1040.110 1040.130 1040.150 1040.190 1040.240 1040.300  
1040.100 1040.120 1040.140 1040.170 1040.220 1040.270 1040.320

serie - set  
14

Icona	Pz.	Sp.†	Sp.†	Sp.†	Sp.†	Sp.†	Sp.†	Sp.†	Sp.†
1041.140	14	3190	8011578968960	new					



# 1041

## SERIE CHIAVI COMBINATE DOPPIA CURVA 75° SET COMBINATION WRENCHES OFFSET 75°

Contenuto - content:

1040.080 8-8 1040.130 13-13 1040.190 19-19  
1040.100 10-10 1040.170 17-17

serie - set  
5

Icona	Pz.	Sp.†	Sp.†	Sp.†	Sp.†	Sp.†	Sp.†	Sp.†
1041.905	5	525	8011578968984	new				

Contenuto - content:

1040.080 8-8 1040.110 11-11 1040.140 14-14 1040.170 17-17  
1040.100 10-10 1040.130 13-13 1040.150 15-15 1040.190 19-19

serie - set  
8

Icona	Pz.	Sp.†	Sp.†	Sp.†	Sp.†	Sp.†	Sp.†	Sp.†
1041.980	8	760	8011578969004	new				

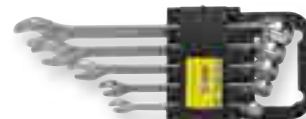

**1043**

**SERIE 8 CHIAVI COMBinate DOPPIA CURVA 75° - scatola cartone**  
 SET 8 COMBINATION WRENCHES OFFSET 75° - box

serie-set  
**8**

Contenuto - content:

1040.080 8-8 1040.110 11-11 1040.140 14-14 1040.170 17-17  
 1040.100 10-10 1040.130 13-13 1040.150 15-15 1040.190 19-19







	Pz.	
<b>1043.080</b>	<b>8</b>	8011578969028

**new**



**1048**

**CHIAVE DOPPIA TORX**  
 DOUBLE RING TORX WRENCH

					
<b>1048.068</b>	<b>E6-E8</b>	112	22	<b>2</b>	8011578964528
<b>1048.102</b>	<b>E10-E12</b>	145	38	<b>2</b>	8011578964542
<b>1048.148</b>	<b>E14-E18</b>	180	80	<b>2</b>	8011578964566
<b>1048.204</b>	<b>E20-E24</b>	220	158	<b>2</b>	8011578964580

**new**

**new**

**new**

**new**



**1048**

**SERIE 4 CHIAVI DOPPIA TORX - scatola**  
 SET 4 DOUBLE RING TORX WRENCHES - box

serie-set  
**4**

Contenuto - content:

1048.068 1048.148  
 1048.102 1048.204

	Pz.		
<b>1048.904</b>	<b>4</b>	300	8011578964603

**new**



**1050**

**PANNELLO ESPOSITORE 158 CHIAVI FORCHETTA - poligonali - combinate - metallo**  
 DISPLAY 158 DOUBLE ENDED WRENCHES - offset - combination - metal

Contenuto - content:

1020.067	6-7	Nr. 6	1025.302	30-32	Nr. 2
1020.089	8-9	Nr. 6	1030.060	6-6	Nr. 6
1020.101	10-11	Nr. 6	1030.070	7-7	Nr. 6
1020.123	12-13	Nr. 6	1030.080	8-8	Nr. 6
1020.145	14-15	Nr. 2	1030.090	9-9	Nr. 6
1020.167	16-17	Nr. 2	1030.100	10-10	Nr. 6
1020.189	18-19	Nr. 2	1030.110	11-11	Nr. 6
1020.202	20-22	Nr. 2	1030.120	12-12	Nr. 6
1020.213	21-23	Nr. 2	1030.130	13-13	Nr. 6
1020.247	24-27	Nr. 2	1030.140	14-14	Nr. 6
1020.258	25-28	Nr. 2	1030.150	15-15	Nr. 2
1020.302	30-32	Nr. 2	1030.160	16-16	Nr. 2
1025.067	6-7	Nr. 6	1030.170	17-17	Nr. 2
1025.089	8-9	Nr. 6	1030.180	18-18	Nr. 2
1025.101	10-11	Nr. 6	1030.190	19-19	Nr. 2
1025.123	12-13	Nr. 6	1030.200	20-20	Nr. 2
1025.145	14-15	Nr. 2	1030.210	21-21	Nr. 2
1025.167	16-17	Nr. 2	1030.220	22-22	Nr. 2
1025.189	18-19	Nr. 2	1030.240	24-24	Nr. 2
1025.202	20-22	Nr. 2	1030.270	27-27	Nr. 2
1025.213	21-23	Nr. 2	1030.300	30-30	Nr. 2
1025.247	24-27	Nr. 2	1030.320	32-32	Nr. 2
1025.258	25-28	Nr. 2			

			
<b>1050.010</b>	990 x 520	21200	8011578050108
<b>1050.210</b>	vuoto - empty	5800	8011578050207



**1051** CHIAVE PER RACCORDI TUBI  
 FLARE NUT OPEN RING WRENCH



Icona	●	L	Icona	●	Barcode
1051.080	8-10	140	41	6	8011578935207
1051.091	9-11	150	58	6	8011578935221
1051.101	10-11	150	53	6	8011578935245
1051.113	11-13	168	89	6	8011578935269
1051.124	12-14	170	103	6	8011578935283
1051.179	17-19	215	157	6	8011578935306
1051.192	19-22	220	232	6	8011578935320
1051.224	22-24	235	251	6	8011578935344
1051.247	24-27	255	324	6	8011578935368
1051.302	30-32	275	413	6	8011578935382

**1051C** SERIE 10 CHIAVI RACCORDI - scatola  
 SET 10 FLARE NUT WRENCHES - box

serie - set  
**10**

Contenuto - content:

- 1051.080 8-10
- 1051.091 9-11
- 1051.101 10-11
- 1051.113 11-13
- 1051.124 12-14
- 1051.179 17-19
- 1051.192 19-22
- 1051.224 22-24
- 1051.247 24-27
- 1051.302 30-32



Icona	Pz.	Icona	Barcode
1051.310	10	1798	8011578051303

**1052** CHIAVE PER PONTEGGI  
 OFFSET DOUBLE RING WRENCH BUILDING



Icona	●	L	Icona	●	Barcode
1052.212	21-22	335	486	6	8011578935689

**1053** CHIAVE PER PONTEGGI A CRICCHETTO REVERSIBILE  
 RACHET WRENCH REVERSIBLE FOR BUILDING



Icona	●	L	Icona	●	Barcode
1053.212	21-22	310	414	2	8011578961084

new



**1055** CHIAVE COMBINATA A CRICCHETTO SNODATA  
 COMBINATION FLEX RATCHET WRENCH



72 denti - ripresa 5°  
 72 teeth - 5° action

Icona	●	L	Icona	●	Barcode
	<b>1055.080</b>	<b>8-8</b>	145	50	<b>6</b> 8011578935405
	<b>1055.090</b>	<b>9-9</b>	155	68	<b>6</b> 8011578935429
	<b>1055.100</b>	<b>10-10</b>	155	66	<b>6</b> 8011578935443
	<b>1055.110</b>	<b>11-11</b>	165	85	<b>6</b> 8011578935467
	<b>1055.120</b>	<b>12-12</b>	180	117	<b>6</b> 8011578935481
	<b>1055.130</b>	<b>13-13</b>	180	114	<b>6</b> 8011578935504
	<b>1055.140</b>	<b>14-14</b>	190	136	<b>6</b> 8011578935528
	<b>1055.150</b>	<b>15-15</b>	205	155	<b>6</b> 8011578935542
	<b>1055.160</b>	<b>16-16</b>	205	162	<b>6</b> 8011578935566
	<b>1055.170</b>	<b>17-17</b>	222	227	<b>6</b> 8011578935580
	<b>1055.180</b>	<b>18-18</b>	222	213	<b>6</b> 8011578935603
	<b>1055.190</b>	<b>19-19</b>	240	250	<b>6</b> 8011578935627

**1056** SERIE CHIAVI COMBINATE A CRICCHETTO SNODATE - scatola  
 SET COMBINATION FLEX RATCHET WRENCHES - box

Contenuto - content:

- 1055.080 8-8
- 1055.100 10-10
- 1055.130 13-13
- 1055.170 17-17
- 1055.190 19-19

serie - set  
**5**

Pz.  
**1056.050** **5**

**747** 8011578056308



Contenuto - content:

- 1055.080 8-8
- 1055.100 10-10
- 1055.110 11-11
- 1055.120 12-12
- 1055.130 13-13
- 1055.140 14-14
- 1055.170 17-17
- 1055.190 19-19

serie - set  
**8**

Pz.  
**1056.080** **8**

**1080** 8011578056322



Contenuto - content:

- 1055.080 8-8
- 1055.090 9-9
- 1055.100 10-10
- 1055.110 11-11
- 1055.120 12-12
- 1055.130 13-13
- 1055.140 14-14
- 1055.150 15-15
- 1055.160 16-16
- 1055.170 17-17
- 1055.180 18-18
- 1055.190 19-19

serie - set  
**12**

Pz.  
**1056.120** **12**

**1674** 8011578056339

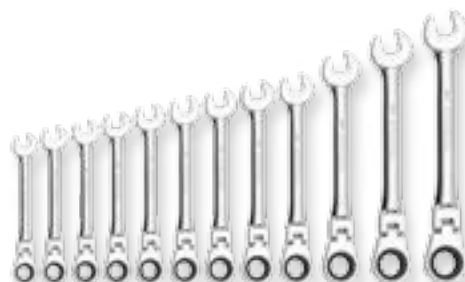



## 1056 SERIE CHIAVI COMBinate A CRICCHETTO SNODATE

### SET COMBINATION FLEX RATCHET WRENCHES

Contenuto - content:

1055.080 8-8  
 1055.100 10-10  
 1055.130 13-13  
 1055.170 17-17  
 1055.190 19-19

serie - set  
**5**

	Pz.		
<b>1056.905</b>	<b>5</b>	808	8011578056346

serie - set  
**11**

Contenuto - content:

1055.080 8-8	1055.150 15-15
1055.100 10-10	1055.160 16-16
1055.110 11-11	1055.170 17-17
1055.120 12-12	1055.180 18-18
1055.130 13-13	1055.190 19-19
1055.140 14-14	

	Pz.		
<b>1056.911</b>	<b>11</b>	1758	8011578056353

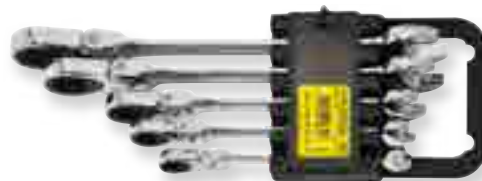

## 1057 SERIE CHIAVI COMBinate A CRICCHETTO SNODATE - busta tela avvolgibile

### SET COMBINATION FLEX RATCHET WRENCHES - envelope canvas roller blind

Contenuto - content:

1055.080 8-8	1055.130 13-13
1055.100 10-10	1055.140 14-14
1055.110 11-11	1055.170 17-17
1055.120 12-12	1055.190 19-19

serie - set  
**8**

	Pz.		
<b>1057.080</b>	<b>8</b>	1123	8011578057350



Contenuto - content:

1055.080 8-8	1055.140 14-14
1055.090 9-9	1055.150 15-15
1055.100 10-10	1055.160 16-16
1055.110 11-11	1055.170 17-17
1055.120 12-12	1055.180 18-18
1055.130 13-13	1055.190 19-19

serie - set  
**12**

	Pz.		
<b>1057.120</b>	<b>12</b>	1802	8011578057039



## 1058 ESPOSITORE 24 CHIAVI COMBinate A CRICCHETTO SNODATE

### DISPLAY 24 COMBINATION FLEX RATCHET WRENCHES

Contenuto - content:

1055.080 8-8	Nr. 2	1055.170 17-17	Nr. 2
1055.090 9-9	Nr. 2	1055.180 18-18	Nr. 2
1055.100 10-10	Nr. 2	1055.190 19-19	Nr. 2
1055.110 11-11	Nr. 2		
1055.120 12-12	Nr. 2		
1055.130 13-13	Nr. 2		
1055.140 14-14	Nr. 2		
1055.150 15-15	Nr. 2		
1055.160 16-16	Nr. 2		

	L x l x P		
<b>1058.010</b>	300 x 370 x 100	5700	8011578058401



**1060** CHIAVE COMBINATA A CRICCHETTO REVERSIBILE  
 COMBINATION REVERSIBLE RATCHET WRENCH



72 denti - ripresa 5° - testa inclinata 15°  
 72 teeth - 5° action - 15° offset head

Icona	Dimensione	Lunghezza	Peso	Icona	Barcode	Numero
	<b>8-8</b>	140	42		011578    000004	6 8011578935702
	<b>9-9</b>	150	46			6 8011578935726
	<b>10-10</b>	160	66			6 8011578935740
	<b>11-11</b>	160	66			6 8011578935764
	<b>12-12</b>	170	84			6 8011578935788
	<b>13-13</b>	177	106			6 8011578935801
	<b>14-14</b>	185	126			6 8011578935825
	<b>15-15</b>	197	130			6 8011578935849
	<b>16-16</b>	210	150			6 8011578935863
	<b>17-17</b>	220	193			6 8011578935887
	<b>18-18</b>	230	216			6 8011578935900
	<b>19-19</b>	240	242			6 8011578935924
	<b>22-22</b>	280	378			6 8011578965785 <b>new</b>
	<b>24-24</b>	310	500			6 8011578965808 <b>new</b>

**1061** SERIE CHIAVI COMBINATE A CRICCHETTO REVERSIBILE - scatola cartone  
 SET COMBINATION REVERSIBLE RATCHET WRENCHES - box

Contenuto - content:

- 1060.080 8-8
- 1060.100 10-10
- 1060.110 11-11
- 1060.120 12-12
- 1060.130 13-13
- 1060.140 14-14
- 1060.170 17-17
- 1060.190 19-19



Icona	Pz.	Peso	Barcode	Numero
	<b>8</b>	962	011578    000004	8011578061081



Contenuto - content:

- 1060.080 8-8
- 1060.090 9-9
- 1060.100 10-10
- 1060.110 11-11
- 1060.120 12-12
- 1060.130 13-13
- 1060.140 14-14
- 1060.150 15-15
- 1060.160 16-16
- 1060.170 17-17
- 1060.180 18-18
- 1060.190 19-19



Icona	Pz.	Peso	Barcode	Numero
	<b>12</b>	1498	011578    000004	8011578061128



## 1061 SERIE CHIAVI COMBinate A CRICCHETTO REVERSIBILE SET COMBINATION REVERSIBLE RATCHET WRENCHES

Contenuto - content:

1060.080 8-8  
1060.100 10-10  
1060.130 13-13  
1060.170 17-17  
1060.190 19-19

serie - set  
**5**

 Pz.  
**1061.905 5**

 692  
8011578 000004  
8011578969042



Contenuto - content:

1060.080 8-8  
1060.100 10-10  
1060.110 11-11  
1060.120 12-12  
1060.130 13-13  
1060.140 14-14  
1060.150 15-15  
1060.160 16-16  
1060.170 17-17  
1060.180 18-18  
1060.190 19-19

serie - set  
**11**

 Pz.  
**1061.911 11**

 1548  
8011578 000004  
8011578969066



## 1062 SERIE CHIAVI COMBinate A CRICCHETTO REVERSIBILE - busta tela avvolgibile SET COMBINATION REVERSIBLE RATCHET WRENCHES - envelope canvas roller blind

Contenuto - content:

1060.080 8-8  
1060.100 10-10  
1060.110 11-11  
1060.120 12-12  
1060.130 13-13  
1060.140 14-14  
1060.170 17-17  
1060.190 19-19

serie - set  
**8**

 Pz.  
**1062.080 8**

 983  
8011578 000004  
8011578062088



Contenuto - content:

1060.080 8-8  
1060.090 9-9  
1060.100 10-10  
1060.110 11-11  
1060.120 12-12  
1060.130 13-13  
1060.140 14-14  
1060.150 15-15  
1060.160 16-16  
1060.170 17-17  
1060.180 18-18  
1060.190 19-19

serie - set  
**12**

 Pz.  
**1062.120 12**

 1585  
8011578 000004  
8011578062125



**1063**

**SERIE CHIAVI COMBinate A CRICCHETTO REVERSIBILE - scatola cartone**  
**SET COMBINATION REVERSIBLE RATCHET WRENCHES - box**

Contenuto - content:

- 1060.080 8-8
- 1060.100 10-10
- 1060.110 11-11
- 1060.120 12-12
- 1060.130 13-13
- 1060.140 14-14
- 1060.170 17-17
- 1060.190 19-19

serie-set  
**8**



Pz.

**1063.080**

**8**



1028



8011578063085



Contenuto - content:

- 1060.080 8-8
- 1060.090 9-9
- 1060.100 10-10
- 1060.110 11-11
- 1060.120 12-12
- 1060.130 13-13
- 1060.140 14-14
- 1060.150 15-15
- 1060.160 16-16
- 1060.170 17-17
- 1060.180 18-18
- 1060.190 19-19

serie-set  
**12**



Pz.

**1063.120**

**12**



1674



8011578063122



**1064**

**ESPOSITORE 24 CHIAVI COMBinate A CRICCHETTO REVERSIBILE**  
**DISPLAY 24 COMBINATION REVERSIBLE RATCHET WRENCHES**

Contenuto - content:

- 1060.080 8-8 Nr. 2
- 1060.090 9-9 Nr. 2
- 1060.100 10-10 Nr. 2
- 1060.110 11-11 Nr. 2
- 1060.120 12-12 Nr. 2
- 1060.130 13-13 Nr. 2
- 1060.140 14-14 Nr. 2
- 1060.150 15-15 Nr. 2
- 1060.160 16-16 Nr. 2
- 1060.170 17-17 Nr. 2
- 1060.180 18-18 Nr. 2
- 1060.190 19-19 Nr. 2



L x l x h

**1064.010**

300 x 370 x 100







5200



8011578969721



**1065** CHIAVE COMBINATA A CRICCHETTO SEMPLICE - CORTA  
 COMBINATION RATCHET WRENCH - STUBBY

Icona	Spessore	Lunghezza	Spessore	Quantità	Barcode	Modello	Stato
					81157811000004		
1065.080	8	90	32	2	8011578967383		new
1065.100	10	95	42	2	8011578967406		new
1065.130	13	107	82	2	8011578967420		new
1065.170	17	126	152	2	8011578967444		new
1065.190	19	136	170	2	8011578967468		new



**1065** SERIE 5 CHIAVI COMBINATE A CRICCHETTO SEMPLICE - CORTA  
 SET 5 COMBINATION RATCHET WRENCHES - STUBBY





Contenuto - content:  
 1065.080 8-8  
 1065.100 10-10  
 1065.130 13-13  
 1065.170 17-17  
 1065.190 19-19

Icona	Pz.	Spessore	Barcode	Modello	Stato
			81157811000004		
1065.905	5	552	8011578969080		new



**1067** CHIAVE COMBINATA A CRICCHETTO SEMPLICE  
 COMBINATION RATCHET WRENCH

72 denti - ripresa 5°  
 72 teeth - 5° action

Icona	Spessore	Lunghezza	Spessore	Quantità	Barcode	Modello	Stato
					81157811000004		
1067.080	8-8	135	40	6	8011578963187		new
1067.100	10-10	153	64	6	8011578963200		new
1067.130	13-13	178	100	6	8011578963224		new
1067.170	17-17	222	196	6	8011578963248		new
1067.190	19-19	240	246	6	8011578963262		new



**1068** SERIE 5 CHIAVI COMBINATE A CRICCHETTO SEMPLICE - scatola  
 SET 5 COMBINATION RATCHET WRENCHES - box

Contenuto - content:  
 1067.080 8-8  
 1067.100 10-10  
 1067.130 13-13  
 1067.170 17-17  
 1067.190 19-19



Icona	Pz.	Spessore	Barcode	Modello	Stato
			81157811000004		
1068.050	5	692	8011578067014		new



**1068** SERIE 5 CHIAVI COMBINATE A CRICCHETTO SEMPLICE  
 SET 5 COMBINATION RATCHET WRENCHES



Contenuto - content:  
 1067.080 8-8                      1067.170 17-17  
 1067.100 10-10                  1067.190 19-19  
 1067.130 13-13



Icona	Pz.	Spessore	Barcode	Modello	Stato
			81157811000004		
1068.905	5	716	8011578067007		new



## 1069 ADATTATORE PER CHIAVI A CRICCHETTO ADAPTER FOR RATCHET WRENCHES

	per chiave for wrench				011578     000004
 <b>1069.104</b>	1/4"	mm. 10	8	6	8011578944247
<b>1069.138</b>	3/8"	mm. 13	18	6	8011578944261
<b>1069.192</b>	1/2"	mm. 19	48	6	8011578944285
	per chiave for wrench				011578     000004
 <b>1069.914</b>	inserti-bit 1/4"	mm. 10	8	6	8011578944308
	per chiave for wrench				011578     000004
 <b>1069.990</b>	set 4 adattatori		88	1	8011578944322



## 1070 CHIAVE REGOLABILE - acciaio chrom-vanadium finitura cromata - impugnatura plasticata ADJUSTABLE WRENCH - chrom-vanadium steel chrome plated finish - plastic handle



DIN 3117 ISO 6787

	↔-L-↔	†			011578     000004
 <b>1070.015</b>	150	19	152	2	8011578927073
<b>1070.020</b>	200	24	274	2	8011578927103
<b>1070.025</b>	250	30	450	2	8011578927134
<b>1070.030</b>	300	34	756	2	8011578927165
<b>1070.037</b>	375	44	1360	1	8011578943189
<b>1070.045</b>	450	55	1980	1	8011578943202

## 1074 CHIAVI POLIGONALI CURVE PESANTI - acciaio chrom-vanadium finitura cromata HEAVY-DUTY OFFSET RING WRENCHES - chrom-vanadium steel chrome plated finish

	◆	↔-L-↔			011578     000004	
 <b>1074.024</b>	24	182	462	1	8011578961107	new
<b>1074.027</b>	27	192	518	1	8011578961121	new
<b>1074.030</b>	30	202	590	1	8011578961145	new
<b>1074.032</b>	32	237	832	1	8011578961169	new
<b>1074.036</b>	36	247	910	1	8011578961183	new
<b>1074.041</b>	41	267	1062	1	8011578961206	new
<b>1074.046</b>	46	282	1434	1	8011578961220	new
<b>1074.050</b>	50	292	1450	1	8011578961244	new
<b>1074.055</b>	55	302	1650	1	8011578961268	new
<b>1074.060</b>	60	347	2700	1	8011578961282	new
<b>1074.065</b>	65	357	3100	1	8011578961305	new
<b>1074.070</b>	70	365	3400	1	8011578961329	new









## 1074Z IMPUGNATURA TUBO per chiavi poligonali curve pesanti (per chiave 1074) PIPE for heavy-duty offset ring wrench (for wrench 1074)

	∅	↔-L-↔			011578     000004
 <b>1074.946</b>	19	460 x mm 24/27/30	760	1	8011578961367
<b>1074.961</b>	22	610 x mm 32/36/41	1128	1	8011578961381
<b>1074.976</b>	25	760 x mm 46/50/55	1550	1	8011578961404
<b>1074.986</b>	30	860 x mm 60/65/70	2500	1	8011578961428









## 1075 CHIAVE A PERCUSSIONE A FORCHETTA OPEN STRICKEN WRENCH



					
1075.024	24	160	280	1	8011578941161
1075.027	27	180	350	1	8011578941444
1075.030	30	190	542	1	8011578941468
1075.032	32	196	770	1	8011578941482
1075.036	36	210	900	1	8011578941505
1075.041	41	225	1065	1	8011578941529
1075.046	46	251	1114	1	8011578941543
1075.050	50	275	1650	1	8011578941567
1075.055	55	304	2200	1	8011578941581
1075.060	60	320	2600	1	8011578941604
1075.065	65	340	2700	1	8011578941628
1075.070	70	365	4000	1	8011578941642
1075.075	75	278	5000	1	8011578960322
1075.080	80	400	5700	1	8011578941666
1075.085	85	400	6000	1	8011578960346
1075.090	90	445	8500	1	8011578941680
1075.095	95	445	9800	1	8011578941703
1075.100	100	485	12200	1	8011578941727

## 1076 CHIAVE A PERCUSSIONE POLIGONALE RING STRICKEN WRENCH









					
1076.024	24	167	296	1	8011578941741
1076.027	27	179	303	1	8011578941765
1076.030	30	191	383	1	8011578941789
1076.032	32	197	474	1	8011578941802
1076.036	36	206	522	1	8011578941826
1076.041	41	231	758	1	8011578941840
1076.046	46	241	853	1	8011578941864
1076.050	50	255	1134	1	8011578941888
1076.055	55	271	1560	1	8011578941901
1076.060	60	279	1500	1	8011578941925
1076.065	65	295	2100	1	8011578941949
1076.070	70	323	3100	1	8011578941963
1076.075	75	330	3100	1	8011578960360
1076.080	80	361	3200	1	8011578941987
1076.085	85	361	4000	1	8011578960384
1076.090	90	390	6000	1	8011578942007
1076.095	95	390	6700	1	8011578942021
1076.100	100	400	7400	1	8011578942045



**1077**

**CHIAVE GAS  
 WRENCH GAS**









					
1077.025	25	135	106	12	8011578961442

new

**1078**

**CHIAVE DUE BOCHE DIN 895 - finitura zincata  
 WRENCH DOUBLE OPEN DIN 895 - zinc finish**



					
1078.067	6x7	96	16	12	8011578961466
1078.078	7x8	107	18	12	8011578961480
1078.083	8x9	110	24	12	8011578963040
1078.085	8x10	115	28	12	8011578961503
1078.101	10x11	118	32	12	8011578961527
1078.103	10x13	122	36	12	8011578961541
1078.123	12x13	142	42	12	8011578961565
1078.137	13x17	155	78	12	8011578961589
1078.175	17x19	170	104	12	8011578961602
1078.177	17x22	198	144	12	8011578961626
1078.192	19x22	198	154	12	8011578961640
1078.194	19x24	207	168	12	8011578961664
1078.202	20x22	198	170	12	8011578961688
1078.224	22x24	218	170	6	8011578961701
1078.242	24x27	240	236	6	8011578961725
1078.243	24x30	265	400	6	8011578964627
1078.273	27x30	270	420	6	8011578964641
1078.302	30x32	275	436	6	8011578961749
1078.363	36x41	340	755	6	8011578969745

new

new

new

new

new

new

new

new

new

new

new

new

new

new

new

new

new

new







new

new

**1079**

**CHIAVE UNA BOCCA DIN 894 - finitura zincata  
 WRENCH SINGLE OPEN DIN 894 - zinc finish**



					
1079.006	6	75	11	12	8011578961763
1079.007	7	75	12	12	8011578961787
1079.008	8	95	12	12	8011578961800
1079.009	9	105	22	12	8011578961824
1079.010	10	105	18	12	8011578961848
1079.012	12	125	20	12	8011578965761
1079.013	13	125	38	12	8011578961862
1079.015	15	140	40	12	8011578969769
1079.017	17	160	70	12	8011578961886
1079.019	19	170	78	12	8011578961909
1079.022	22	195	106	12	8011578961923
1079.024	24	215	132	6	8011578961947
1079.027	27	240	218	6	8011578961961
1079.030	30	260	254	6	8011578961985
1079.032	32	275	288	6	8011578962005
1079.034	34	275	300	6	8011578963507
1079.036	36	300	410	6	8011578962029
1079.038	38	305	437	6	8011578965860
1079.041	41	340	534	6	8011578962043
1079.042	42	345	581	6	8011578969783
1079.046	46	375	782	6	8011578962067
1079.050	50	405	1200	6	8011578962081
1079.055	55	450	1352	6	8011578962104
1079.060	60	475	1756	6	8011578962128
1079.065	65	515	1600	6	8011578962142
1079.070	70	560	2000	2	8011578963064
1079.075	75 nere-black	600	2990	6	8011578969806
1079.080	80 nere-black	670	4140	6	8011578969820
1079.090	90 nere-black	680	3640	6	8011578969868
1079.095	95 nere-black	847	6300	6	8011578969882
1079.100	100 nere-black	847	6450	6	8011578969905
1079.105	105 nere-black	1000	6350	6	8011578969929

new

new

new

new

new

new

new

new

new

new

new

new

new

new

new

new

new

new

new

new

new

new

new

new

new

new

new

new

new

new

new

new

new

new



## 1080 CHIAVE A TUBO DOPPIA - FERRO tipo leggero - finitura zincata

TUBULAR WRENCH - IRON light type - zinc finish

Icona	●	←-L→	foro-hole	👤	👉	Barcode
1080.067	6-7	95	5	35	6	8011578927196
1080.089	8-9	95	5	38	6	8011578927226
1080.101	10-11	105	5	45	6	8011578927257
1080.123	12-13	110	6,5	52	6	8011578927288
1080.145	14-15	115	8	72	6	8011578927318
1080.167	16-17	115	8	80	6	8011578927349
1080.189	18-19	130	8	96	6	8011578927370
1080.202	20-22	135	8	153	6	8011578927400
1080.246	24-26	145	10	190	6	8011578927431
1080.258	25-28	160	10	215	6	8011578927462
1080.302	30-32	165	12	267	6	8011578927493
1080.555	55-55	200	12	577	2	8011578927523



## 1081 SERIE CHIAVI A TUBO - FERRO tipo leggero - scatola

SET TUBULAR WRENCHES - IRON light type - box

Contenuto - content:

1080.067	6-7	1080.123	12-13
1080.089	8-9	1080.145	14-15
1080.101	10-11	1080.167	16-17

serie - set  
**6**

Icona	Pz.	👤	Barcode
1081.060	6	348	8011578081003

Contenuto - content:

1080.067	6-7	1080.145	14-15
1080.089	8-9	1080.167	16-17
1080.101	10-11	1080.189	18-19
1080.123	12-13	1080.202	20-22

serie - set  
**8**

Icona	Pz.	👤	Barcode
1081.080	8	608	8011578081027

Contenuto - content:

1080.067	6-7	1080.189	18-19
1080.089	8-9	1080.202	20-22
1080.101	10-11	1080.246	24-26
1080.123	12-13	1080.258	25-28
1080.145	14-15	1080.302	30-32
1080.167	16-17		

serie - set  
**11**

Icona	Pz.	👤	Barcode
1081.110	11	1270	8011578081041



## 1090 CHIAVE A PIPA DOPPIA - FERRO tipo leggero - finitura zincata

OFFSET TUBULAR WRENCHES - IRON light type - zinc finish

Icona	●	←-L→	👤	👉	Barcode	
1090.060	6-6	85	30	28	6	8011578927554
1090.070	7-7	85	30	32	6	8011578927585
1090.080	8-8	90	30	68	6	8011578927615
1090.090	9-9	90	35	70	6	8011578927646
1090.100	10-10	95	35	58	6	8011578927677
1090.110	11-11	100	40	92	6	8011578927707
1090.120	12-12	100	40	102	6	8011578927738
1090.130	13-13	110	50	100	6	8011578927769
1090.140	14-14	110	50	110	6	8011578927790
1090.150	15-15	110	50	130	6	8011578927820
1090.160	16-16	120	50	128	6	8011578927851
1090.170	17-17	120	55	138	6	8011578927882
1090.190	19-19	130	60	132	6	8011578927943
1090.200	20-20	135	70	205	6	8011578927974
1090.220	22-22	145	70	194	6	8011578928032



**1092**

**CHIAVE A TUBO DOPPIA PROFESSIONALE - acciaio chrom vanadium**  
**DOUBLE TUBULAR WRENCHES - PROFESSIONAL - chrom vanadium steel**



Icona	●	↳-L-↳	foro-hole	👤	📦	Barcode	Descrizione
	<b>1092.067</b>	<b>6-7</b>	110	7	38	6	8011578935948
	<b>1092.089</b>	<b>8-9</b>	110	7	42	6	8011578935962
	<b>1092.101</b>	<b>10-11</b>	122	7	72	6	8011578935986
	<b>1092.123</b>	<b>12-13</b>	140	9	93	6	8011578936006
	<b>1092.145</b>	<b>14-15</b>	140	9	95	6	8011578936020
	<b>1092.167</b>	<b>16-17</b>	152	10,5	124	6	8011578936044
	<b>1092.189</b>	<b>18-19</b>	162	13	172	6	8011578936068
	<b>1092.202</b>	<b>20-22</b>	172	13	253	6	8011578936082
	<b>1092.213</b>	<b>21-23</b>	172	15	222	2	8011578936105
	<b>1092.246</b>	<b>24-26</b>	195	15	407	2	8011578936129
	<b>1092.258</b>	<b>25-28</b>	192	16	394	2	8011578936143
	<b>1092.279</b>	<b>27-29</b>	200	16	414	2	8011578936167
	<b>1092.302</b>	<b>30-32</b>	205	17	450	2	8011578936181

**1093**

**SERIE CHIAVI TUBO DOPPIE - scatola cartone**  
**SET DOUBLE TUBULAR WRENCHES - box**

Contenuto - content:

- 1092.067 6-7
- 1092.089 8-9
- 1092.101 10-11
- 1092.123 12-13
- 1092.145 14-15
- 1092.167 16-17
- 1092.189 18-19
- 1092.202 20-22

serie-set  
**8**



Pz.

**1093.080**

**8**



917



8011578093105



Contenuto - content:

- 1092.067 6-7      1092.246 24-26
- 1092.089 8-9      1092.258 25-28
- 1092.101 10-11    1092.302 30-32
- 1092.123 12-13
- 1092.145 14-15
- 1092.167 16-17
- 1092.189 18-19
- 1092.202 20-22
- 1092.213 21-23

serie-set  
**12**



Pz.

**1093.120**

**12**



2500



8011578093150



**1093A**

**SERIE CHIAVI TUBO DOPPIE - busta tela avvolgibile**  
**SET DOUBLE TUBULAR WRENCHES - envelope canvas roller blind**

Contenuto - content:

- 1092.067 6-7      1092.145 14-15
- 1092.089 8-9      1092.167 16-17
- 1092.101 10-11    1092.189 18-19
- 1092.123 12-13    1092.202 20-22

serie-set  
**8**



Pz.

**1093.180**

**8**



942



8011578093006



## 1096 CHIAVE A TUBO DOPPIA PESANTE CR-VA DOUBLE ENDED HEAVY TUBULAR WRENCH



Icona	●	↔	foro-hole	📏	📦	Barcode
1096.067	6-7	105	3,5	41	6	8011578936204
1096.089	8-9	110	4,0	54	6	8011578936228
1096.101	10-11	120	5,5	75	6	8011578936242
1096.123	12-13	135	5,5	102	6	8011578936266
1096.145	14-15	145	5,5	150	6	8011578936280
1096.167	16-17	155	8,0	184	6	8011578936303
1096.189	18-19	165	9,0	266	6	8011578936327
1096.202	20-22	175	10,0	322	6	8011578936341

## 1097 SERIE CHIAVI TUBO PESANTI - scatola cartone SET ENDED HEAVY TUBULAR WRENCHES - box

Contenuto - content:

1096.067 6-7  
1096.089 8-9  
1096.101 10-11  
1096.123 12-13  
1096.145 14-15  
1096.167 16-17  
1096.189 18-19  
1096.202 20-22

 serie-set  
8

Icona	Pz.	📏	Barcode
1097.080	8	1214	8011578097202

## 1097A SERIE CHIAVI TUBO PESANTI - busta tela avvolgibile SET ENDED HEAVY TUBULAR WRENCHES - envelope canvas roller blind

Contenuto - content:

1096.067 6-7  
1096.089 8-9  
1096.101 10-11  
1096.123 12-13  
1096.145 14-15  
1096.167 16-17  
1096.189 18-19  
1096.202 20-22

 serie-set  
8

Icona	Pz.	📏	Barcode
1097.180	8	1264	8011578097059

## 1097Z SPINA DI MANOVRA PER CHIAVI A TUBO DRIVE BAR









Icona	∅	📏	📦	Barcode
1097.910	5 x 8 x 10	102	6	8011578938987
1097.912	12	120	6	8011578969103
1097.914	14	130	6	8011578969127
1097.919	19	150	6	8011578969943

**1098**

**CHIAVE A PIPA PASSANTE DOPPIA - ESAGONO - POLIGONALE**  
**ANGLE OPEN SOCKETS WRENCH - HEXAGON - BIHEXAGON**



					
<b>1098.060</b>	<b>6-6</b>	108 33	77	<b>6</b>	8011578936464
<b>1098.070</b>	<b>7-7</b>	110 36	73	<b>6</b>	8011578936488
<b>1098.080</b>	<b>8-8</b>	113 34	89	<b>6</b>	8011578936501
<b>1098.090</b>	<b>9-9</b>	122 35	86	<b>6</b>	8011578936525
<b>1098.100</b>	<b>10-10</b>	131 40	114	<b>6</b>	8011578936549
<b>1098.110</b>	<b>11-11</b>	138 40	125	<b>6</b>	8011578936563
<b>1098.120</b>	<b>12-12</b>	145 42	164	<b>6</b>	8011578936587
<b>1098.130</b>	<b>13-13</b>	162 44	192	<b>6</b>	8011578936600
<b>1098.140</b>	<b>14-14</b>	170 46	204	<b>6</b>	8011578936624
<b>1098.150</b>	<b>15-15</b>	180 48	217	<b>6</b>	8011578936648
<b>1098.160</b>	<b>16-16</b>	185 52	244	<b>6</b>	8011578936662
<b>1098.170</b>	<b>17-17</b>	190 52	306	<b>6</b>	8011578936686
<b>1098.180</b>	<b>18-18</b>	200 59	356	<b>6</b>	8011578936709
<b>1098.190</b>	<b>19-19</b>	210 59	442	<b>6</b>	8011578936723
<b>1098.200</b>	<b>20-20</b>	220 65	482	<b>2</b>	8011578936747
<b>1098.210</b>	<b>21-21</b>	222 68	575	<b>2</b>	8011578936761
<b>1098.220</b>	<b>22-22</b>	230 68	548	<b>2</b>	8011578936785
<b>1098.230</b>	<b>23-23</b>	245 75	678	<b>2</b>	8011578936808
<b>1098.240</b>	<b>24-24</b>	250 80	782	<b>2</b>	8011578936822
<b>1098.270</b>	<b>27-27</b>	285 90	975	<b>2</b>	8011578936846
<b>1098.300</b>	<b>30-30</b>	320 100	1352	<b>2</b>	8011578936860
<b>1098.320</b>	<b>32-32</b>	355 105	1526	<b>2</b>	8011578936884

**1099**

**SERIE CHIAVI PIPA DOPPIE - scatola cartone**  
**SET ANGLE OPEN SOCKETS WRENCHES - box**

Contenuto - content:

1098.080 8-8	1098.130 13-13
1098.090 9-9	1098.140 14-14
1098.100 10-10	1098.170 17-17
1098.110 11-11	1098.190 19-19

serie - set  
**8**

	Pz.		
<b>1099.080</b>	<b>8</b>	1636	8011578099305



Contenuto - content:

1098.060 6-6	1098.100 10-10	1098.140 14-14
1098.070 7-7	1098.110 11-11	1098.170 17-17
1098.080 8-8	1098.120 12-12	1098.190 19-19
1098.090 9-9	1098.130 13-13	1098.220 22-22

serie - set  
**12**

	Pz.		
<b>1099.120</b>	<b>12</b>	2600	8011578099350



Contenuto - content:

1098.060 6-6	1098.120 12-12	1098.180 18-18
1098.070 7-7	1098.130 13-13	1098.190 19-19
1098.080 8-8	1098.140 14-14	1098.200 20-20
1098.090 9-9	1098.150 15-15	1098.210 21-21
1098.100 10-10	1098.160 16-16	1098.220 22-22
1098.110 11-11	1098.170 17-17	

serie - set  
**17**

	Pz.		
<b>1099.170</b>	<b>17</b>	4400	8011578099404



**1099**
**SERIE CHIAVI PIPA DOPPIE - scatola cartone**  
 SET ANGLE OPEN SOCKETS WRENCHES - box

Contenuto - content:

1098.060 6-6	1098.140 14-14	1098.220 22-22
1098.070 7-7	1098.150 15-15	1098.230 23-23
1098.080 8-8	1098.160 16-16	1098.240 24-24
1098.090 9-9	1098.170 17-17	1098.270 27-27
1098.100 10-10	1098.180 18-18	1098.300 30-30
1098.110 11-11	1098.190 19-19	1098.320 32-32
1098.120 12-12	1098.200 20-20	
1098.130 13-13	1098.210 21-21	

sette - set  
**22**

Pz.



81157811000004

**1099.220****22**

9600

8011578099459

**1099A**
**SERIE CHIAVI PIPA DOPPIE - busta tela avvolgibile**  
 SET ANGLE OPEN SOCKETS WRENCHES - envelope canvas roller blind

Contenuto - content:

1098.080 8-8
1098.090 9-9
1098.100 10-10
1098.110 11-11
1098.130 13-13
1098.140 14-14
1098.170 17-17
1098.190 19-19

sette - set  
**8**

Pz.



81157811000004

**1099.980****8**

1600

8011578099473

**1100**
**ESPOSITORE 78 CHIAVI TUBO E PIPA**  
 DISPLAY 78 TUBULAR AND ANGLE WRENCHES

Contenuto - content:

1092.067 Nr. 2	1098.120 Nr. 2
1092.089 Nr. 2	1098.130 Nr. 2
1092.101 Nr. 2	1098.140 Nr. 2
1092.123 Nr. 2	1098.150 Nr. 2
1092.145 Nr. 2	1098.160 Nr. 2
1092.167 Nr. 2	1098.170 Nr. 2
1092.189 Nr. 2	1098.180 Nr. 2
1092.202 Nr. 2	1098.190 Nr. 2
1092.213 Nr. 2	1098.200 Nr. 2
1092.246 Nr. 2	1098.210 Nr. 2
1092.258 Nr. 2	1098.220 Nr. 2
1092.279 Nr. 2	
1092.302 Nr. 2	
1096.067 Nr. 2	
1096.089 Nr. 2	
1096.101 Nr. 2	
1096.123 Nr. 2	
1096.145 Nr. 2	
1096.167 Nr. 2	
1096.189 Nr. 2	
1096.202 Nr. 2	
1097.910 Nr. 2	
1098.060 Nr. 2	
1098.070 Nr. 2	
1098.080 Nr. 2	
1098.090 Nr. 2	
1098.100 Nr. 2	
1098.110 Nr. 2	



L-L



81157811000004

**1100.010**

400 x 690

26300

8011578099497

**1100.210**

vuoto - empty

4400

8011578099510

**1150** CHIAVE A "T" SNODATA LUNGA - acciaio chrom-vanadium finitura cromata  
 WRENCH "T" HANDLE LONG - CARDANIC - chrom-vanadium steel chrome plated finish



Icona	Ø	L	Peso	Pz	Barcode
	6	400	242	2	8011578928063
	7	400	186	2	8011578928094
	8	400	184	2	8011578928124
	9	400	248	2	8011578928155
	10	440	292	2	8011578928186
	11	460	376	2	8011578928216
	12	460	296	2	8011578928247
	13	460	392	2	8011578928278
	14	460	390	2	8011578928308
	15	460	588	2	8011578928339
	16	500	556	2	8011578928360
	17	500	590	2	8011578928391
	18	500	552	2	8011578928421
	19	500	608	2	8011578928452
	20	500	636	2	8011578928483
	21	520	946	2	8011578928513
	22	520	940	2	8011578928544
	24	520	1394	2	8011578928575

**1150X** SERIE 4 CHIAVI ESAGONO A "T" SNODATE  
 SET 4 HEXAGON CARDANIC WRENCHES "T" HANDLE

Contenuto-content:

- 1150.080 8
- 1150.100 10
- 1150.130 13
- 1150.170 17

serie - set  
**4**



Icona	Pz.	Peso	Barcode
	4	1472	8011578943721

**1150Z** SERIE 18 CHIAVI A "T" SNODATE LUNGHE  
 SET 18 WRENCHES "T" HANDLE LONG - CARDANIC

Contenuto-content:

- 1150.060 6
- 1150.070 7
- 1150.080 8
- 1150.090 9
- 1150.100 10
- 1150.110 11
- 1150.120 12
- 1150.130 13
- 1150.140 14
- 1150.150 15
- 1150.160 16
- 1150.170 17
- 1150.180 18
- 1150.190 19
- 1150.200 20
- 1150.210 21
- 1150.220 22
- 1150.240 24

serie - set  
**18**



Icona	Pz.	Peso	Barcode
	18	9600	8011578001582

## 1152 CHIAVE "T" SNODATA LUNGA ESAGONO MASCHIO WRENCH "T" HANDLE - CARDANIC - HEX MALE



Icona	Ø	L	h	g	PK	Barcode
1152.030	3	405	186	2	8011578938888	8 011578 000004
1152.040	4	405	186	2	8011578938901	8 011578 000004
1152.050	5	415	300	2	8011578938925	8 011578 000004
1152.060	6	415	300	2	8011578938949	8 011578 000004
1152.080	8	445	390	2	8011578938963	8 011578 000004

## 1155 CHIAVE A "T" SNODATA LUNGA ATTACCO PER CHIAVI A BUSSOLA - acciaio chrom-vanadium finitura cromata WRENCH "T" HANDLE LONG - CARDANIC FOR SOCKET - chrom-vanadium steel chrome plated finish



Icona	Ø	L	h	g	PK	Barcode
1155.005	1/4"	395	180	2	8011578928629	8 011578 000004
1155.010	3/8"	438	375	2	8011578928605	8 011578 000004
1155.020	1/2"	500	646	2	8011578928636	8 011578 000004

## 1158 CHIAVE A "T" SNODATA LUNGA CANDELE WRENCH LONG "T" HANDLE - CARDANIC - SPARK PLUE



Icona	Ø	L	h	g	PK	Barcode
1158.140	14	480	610	2	8011578949587	8 011578 000004
1158.160	16	480	614	2	8011578938840	8 011578 000004
1158.200	21	480	640	2	8011578938864	8 011578 000004

## 1170 CHIAVE A "T" SNODATA CANDELE WRENCH "T" HANDLE - CARDANIC - SPARK PLUE



Icona	Ø	L	h	g	PK	Barcode	new
1170.016	16	240	248	2	8011578967482	8 011578 000004	new
1170.021	21	240	242	2	8011578967505	8 011578 000004	new

## 1325 CHIAVI A "T" CORTE - acciaio finitura nichelata "T" HANDLE SHORT WRENCHES - steel nickel plated finish



Icona	Ø	L	h	g	PK	Barcode
1325.070	7	80 x 70	42	6	8011578928759	8 011578 000004
1325.080	8	95 x 85	60	6	8011578928780	8 011578 000004
1325.100	10	115 x 100	90	6	8011578928841	8 011578 000004
1325.120	12	115 x 100	95	6	8011578928902	8 011578 000004
1325.130	13	135 x 125	166	6	8011578928933	8 011578 000004

**1328** CHIAVE A "T" - acciaio chrom-vanadium finitura cromata  
 "T" HANDLE WRENCH - chrom-vanadium steel chrome plated finish

Icona	●	←-L-→	Icona	Icona	Barcode
1328.060	6	215	130	2	8011578936907
1328.070	7	215	155	2	8011578936921
1328.080	8	235	190	2	8011578936945
1328.090	9	235	256	2	8011578936969
1328.100	10	260	258	2	8011578936983
1328.110	11	260	288	2	8011578937003
1328.120	12	260	330	2	8011578937027
1328.130	13	260	304	2	8011578937041
1328.140	14	260	453	2	8011578937065
1328.150	15	285	438	2	8011578937089
1328.160	16	285	414	2	8011578937102
1328.170	17	285	492	2	8011578937126
1328.180	18	285	538	2	8011578937140
1328.190	19	310	568	2	8011578937164
1328.220	22	310	735	2	8011578937188
1328.240	24	310	1000	2	8011578937201



**1328.904** SERIE 4 CHIAVI ESAGONO A "T" - acciaio chrom-vanadium finitura cromata  
 SET 4 HEX. "T" HANDLE WRENCHES - chrom-vanadium steel chrome plated finish

Icona	Pz.	Icona	Barcode
1328.080	8	235	8011578943745
1328.100	10	260	
1328.130	13	260	
1328.170	17	285	
1328.904	4	1232	8011578943745

serie - set  
4

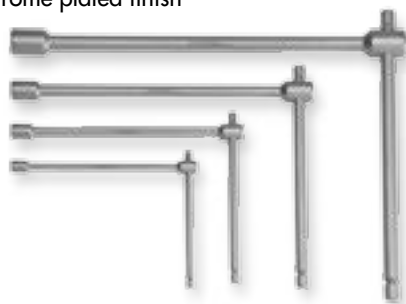

**1334** CHIAVE RUOTE AUTOCARRO - acciaio chrom-vanadium finitura cromata  
 HEAVY DUTY WHEEL WRENCH - chrom-vanadium steel chrome plated finish

Icona	←-L-→	Icona	Icona	Barcode
1334.270	27 x 30	2000	2	8011578937225
1334.272	27 x 32	2100	2	8011578937249
1334.303	30 x 33	2200	2	8011578937263



**1334Z** BARRA  
 BAR

Icona	←-L-→	Icona	Icona	Barcode
1334.910	19 x 400	800	2	8011578937287



**1336** CHIAVE A CROCERA PER RUOTE  
 CROSS WHEEL WRENCH

Icona	←-L-→	Icona	Icona	Barcode
1336.179	17 x 19 x 22 x 1/2"	1350	1	8011578937348
1336.247	24 x 27 x 32 x 3/4"	4100	1	8011578937362





## 1338 LEVAGOMME TIRE LEVEL









  
**1338.050** mm 500 733 **2** 8011578948764

## 1339 LEVERINO LEVEL











  
**1339.010** 450x16 mm. 20 **2** 8011578969967





## 1340 ESTRATTORE REVERSIBILE 2 BRACCI REVERSIBLE 2 JAWS PULLER









  
**1340.010** vite 135 larg. 110 s 85 1000 **1** 8011578938703  
**1340.020** vite 220 larg. 160 s 140 2100 **1** 8011578938727



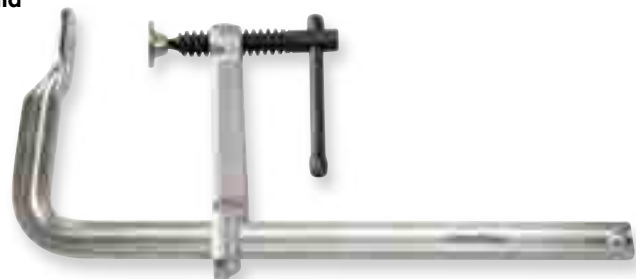

## 1341 ESTRATTORE REVERSIBILE 3 BRACCI REVERSIBLE 3 JAWS PULLER







  
**1341.010** vite 135 larg. 110 s 85 1000 **1** 8011578938741  
**1341.020** vite 220 larg. 160 s 140 2900 **1** 8011578938765





## 1345 STRETTOIO A VITE - acciaio forgiato - finitura cromata CLAMP WITH SCREW - forged - chrome finish







  
**1345.250** 250 x 120 22,00 x 10,50 1200 **1** 8011578948566  
**1345.300** 300 x 140 25,00 x 12,00 1800 **1** 8011578948580  
**1345.400** 400 x 120 25,00 x 12,00 1900 **1** 8011578948603  
**1345.500** 500 x 120 25,00 x 12,00 2100 **1** 8011578948627  
**1345.600** 600 x 120 25,00 x 12,00 2300 **1** 8011578948641

## 1347 STRETTOIO A LEVA CHIUSURA RAPIDA - acciaio forgiato - finitura cromata QUICKLY ADJUSTABLE CLAMP - forged - chrome finish







  
**1347.250** 250 x 120 22,00 x 10,50 2400 **1** 8011578948665  
**1347.300** 300 x 140 25,00 x 12,00 2500 **1** 8011578948689  
**1347.400** 400 x 120 25,00 x 12,00 2800 **1** 8011578948702  
**1347.500** 500 x 120 25,00 x 12,00 3000 **1** 8011578948726

**1350** CHIAVE A SETTORE SNODATA NASELLO QUADRO  
 FLEX HOOK WRENCH - SQUARE NOSE

Icona	↔ L ↔	Icona	Icona	Barcode
				8115781000004
1350.035	15-35	100	1	8011578940485
1350.050	35-50	187	1	8011578940508
1350.080	50-80	405	1	8011578940522
1350.120	80-120	724	1	8011578940546
1350.180	120-180	1294	1	8011578940560



**1352** CHIAVE A SETTORE FISSA NASELLO QUADRO  
 FIX HOOK WRENCH - SQUARE NOSE

Icona	↔ L ↔	Icona	Icona	Barcode
				8115781000004
1352.028	25-28	56	1	8011578940584
1352.032	30-32	56	1	8011578940607
1352.036	34-36	56	1	8011578940621
1352.042	40-42	92	1	8011578940645
1352.050	45-50	152	1	8011578940669
1352.055	52-55	154	1	8011578940683
1352.062	58-62	245	1	8011578940706
1352.075	68-75	240	1	8011578940720
1352.090	80-90	380	1	8011578940744
1352.095	92-95	355	1	8011578944223
1352.100	98-100	367	1	8011578940768
1352.115	110-115	662	1	8011578940782
1352.130	120-130	646	1	8011578940805
1352.145	135-145	1134	1	8011578940829
1352.165	155-165	1134	1	8011578940843
1352.195	180-195	1140	1	8011578940867



**1360** CHIAVE A NASTRO PER FILTRI OLIO  
 OIL FILTER WRENCH

Icona	Ø	Icona	Icona	Barcode
				8115781000004
1360.011	65-110	250	2	8011578944124
1360.015	110-155	256	2	8011578944148



**1360A** NASTRO PER CHIAVI FILTRI OLIO art. 1360  
 SPARE FOR OIL FILTER WRENCHES art. 1360

Icona	↔ L ↔	Icona	Icona	Barcode
				8115781000004
1360.211	110	14	1	8011578964665
1360.215	155	17	1	8011578964689



**1362** CHIAVE A CATENA PER FILTRI OLIO ATTACCO 1/2"  
 OIL FILTER WRENCH CHAIN 1/2"

Icona	Ø	Icona	Icona	Barcode
				8115781000004
1362.015	60-115	388	1	8011578944162



**1363** CHIAVE A CATENA CON MANICO SNODATO PER FILTRI OLIO  
 OIL FILTER WRENCH WITH FLEX HANDLE

Icona	Ø	Icona	Icona	Barcode
				8115781000004
1363.015	60-115	766	1	8011578944186



**1364** CHIAVE A NASTRO  
 OIL FILTER WRENCH



      
 1364.010 60-140 200 1 8011578969981 **new**

**1365** CASSETTA 14 CHIAVI PER TAPPI OLIO - 3/8"  
 SET 14 SOCKETS FOR OIL CAPS - 3/8"



Contenuto-content:  
 esagono-hexagon: mm. 8 9 10 12 14 17  
 quadro-square: mm. 7 8 11 13 5/16" 3/8"  
 quadro femmina-female square mm. 10  
 triangolo-triangular

     
 1365.010 220 x 90 x 50 784 8011578944346 **new**

**1367** SERIE 30 CHIAVI A TAZZA FILTRI OLIO  
 SET 30 CUP FILTER WRENCHES



Contenuto - content:  
 diametri da 65 mm a 108 mm  
 lati da 6 a 45  
 3/8" M - 1/2" F

     
 1367.010 620 x 510 x 90 7100 8011578964702 **new**

**1369** SERIE 37 UTENSILI PISTONCINI FRENI 3/8"  
 SET 37 BRAKE CALIPER TOOLS 3/8"









Contenuto - content:  
 mandrini di rotazione destro e sinistro  
 left and right helix bolt

     
 1369.010 435 x 305 x 60 4250 8011578964726 **new**



**1370** CHIAVE CONNETTORI FRENI  
 FLAT NUT WRENCH



 **1370.101**  10 x 11  175  106  6  8011578964740 **new**

**1371** PRESSORE MOLLE AMMORTIZZATE - 3 PAIA GRAFFE  
 MACPHERSON SPRING DUMPER EXTRACTOR



lunghezza/length 453 mm  
 capacità graffe 80-115 mm  
 88-160 mm  
 126-212 mm  
 NM 10.250 MAX

 **1371.010**  510 x 440 x 120  14700  8011578964764 **new**

**1380** SERIE 7 PINZE FASCETTE STRINGITUBO  
 SET 7 UNIVERSAL HOSE CLAMP PLIERS



 **1380.010**  48 x 380 x 100  3200  8011578964788 **new**

**1383** PINZA FASCETTA STRINGITUBO CON CAVO mm 630  
 HOSE CLAMP PLIER WITH CABLE mm 630



 **1383.010**  210-630  470  1  8011578964801 **new**

## 1385 PINZA FASCETTA PUNTE GIR. 45° - MANICOTTI HOSE CLAMP PLIER 45°



					
1385.010	235	226	1	8011578964825	<b>new</b>







## 1386 PINZA FASCETTA A SCATTO CLIC CLIP-R COLLAR PLIER



					
1386.010	175	250	1	8011578964849	<b>new</b>

## 1388 PINZA FASCETTE - CON ARRESTO VARIE POSIZIONI HOSE CLAMP PLIER - MULTI-STOP



						
1388.038	mm 6-38	240	320	2	8011578964863	<b>new</b>
1388.055	mm 22-55	240	334	2	8011578964887	<b>new</b>

## 1390 SERIE 3 PINZE PER STROZZATURA MANICOTTI ACQUA E BENZINA SET 3 CLAMP PLIERS FOR NARROW WATER AND PETROL PIPE



Contenuto - content:  
 22-60 mm - 63 mm  
 22-42 mm - 29 mm  
 11-19 mm - 18 mm

				
1390.010	mm 150-180-250	226	8011578964900	<b>new</b>

**1400** CHIAVE A BUSSOLA 1/4" BOCCA ESAGONALE PROFILO FLANK DRIVE - acciaio chrom-vanadium finitura cromata  
 SOCKET 1/4" HEXAGON FLANK DRIVE SECTION - chrom-vanadium steel chrome plated finish

DIN 3124 ISO 2725

Model	Size	Length	Width	Depth	Weight	Quantity	Barcode
1400.040	4	25	6,7	12	10	6	8011578929084
1400.045	4,5	25	7,3	12	11	6	8011578929114
1400.050	5	25	8	12	11	6	8011578929145
1400.055	5,5	25	8,5	12	12	6	8011578929176
1400.060	6	25	9	12	12	6	8011578929206
1400.070	7	25	10	12	12	6	8011578929237
1400.080	8	25	11,8	12	12	6	8011578929268
1400.090	9	25	12,5	12	14	6	8011578929299
1400.100	10	25	14	12	14	6	8011578929329
1400.110	11	25	15,5	14	20	6	8011578929350
1400.120	12	25	17	15	22	6	8011578929381
1400.130	13	25	18	16	25	6	8011578929411

1/4"



**1400Z** SERIE 12 CHIAVI A BUSSOLA 1/4" - binario  
 SET 12 SOCKETS 1/4" - holding bar

Contenuto-content:

1400.040	1400.055	1400.080	1400.110
1400.045	1400.060	1400.090	1400.120
1400.050	1400.070	1400.100	1400.130

1400.912	194	8011578944360
----------	-----	---------------

1/4"



**1400ZZ** BINARIO PER BUSSOLE 1/4" mm. 185 - vuoto  
 HOLD. BAR FOR SOCKETS 1/4" mm. 185 - empty

1400.990	185	32	8011578944384
----------	-----	----	---------------

1/4"



**1402** CHIAVE A BUSSOLA 1/4" LUNGA  
 SOCKET 1/4" DEEP

Model	Size	Length	Width	Depth	Weight	Quantity	Barcode
1402.040	4	50	11	7	15	6	8011578941185
1402.045	4,5	50	12	7	17	6	8011578941208
1402.050	5	50	12	8	18	6	8011578941222
1402.055	5,5	50	12	9	20	6	8011578941246
1402.060	6	50	12	9	20	6	8011578941260
1402.070	7	50	12	11	22	6	8011578941284
1402.080	8	50	12	12	23	6	8011578941307
1402.090	9	50	13	13	30	6	8011578941321
1402.100	10	50	14	14	38	6	8011578941345
1402.110	11	50	16	16	42	6	8011578941369
1402.120	12	50	17	17	48	6	8011578941383
1402.130	13	50	18	18	50	6	8011578941406
1402.140	14	50	19	19	68	6	8011578941420

1/4"



**1402Z** SERIE 12 CHIAVI A BUSSOLA 1/4" LUNGHE - binario  
 SET 12 SOCKETS 1/4" LONG - holding bar

Contenuto-content:

1402.040	1402.055	1402.080	1402.110
1402.045	1402.060	1402.090	1402.120
1402.050	1402.070	1402.100	1402.130

1402.912	368	8011578944407
----------	-----	---------------

1/4"



## 1404 CHIAVE A BUSSOLA 1/4" FEMMINA TX E SOCKET 1/4" TX E FEMALE

Model	E	25	12	7	10	6	SKU
1404.040	E 4	25	12	7	10	6	8011578944421
1404.050	E 5	25	12	7	10	6	8011578944445
1404.060	E 6	25	12	8	11	6	8011578944469
1404.070	E 7	25	12	9	12	6	8011578944483
1404.080	E 8	25	12	10	12	6	8011578944506
1404.100	E 10	25	12	13	18	6	8011578944520

1/4"



## 1404Z SERIE 6 CHIAVI A BUSSOLA TORX 1/4" - binario SET 6 SOCKETS TORX 1/4" - holding bar

Contenuto-content:

1404.040	E 4	1404.060	E 6	1404.080	E 8
1404.050	E 5	1404.070	E 7	1404.100	E 10

1/4"



Model	E	102	SKU
1404.906	E 102	102	8011578944544

## 1405 CRICCHETTO REVERSIBILE 1/4" CON SGANCIO RAPIDO - acciaio chrom-vanadium finitura cromata - impugnatura plastica RATCHET 1/4" REVERSIBLE QUICK RELEASE - chrom-vanadium steel chrome plated finish - plastic handle

Model	140	23 x 25,5	60	118	2	SKU
1405.010	140	23 x 25,5	60	118	2	8011578929442



## 1405Z CRICCHETTO REVERSIBILE 1/4" TELESCOPICO - SNODATO - acciaio chrom-vanadium finitura cromata RATCHET 1/4" REVERSIBLE TELESCOPIC - FLEX - chrom-vanadium steel chrome plated finish

Model	255/355	32 x 33	90	505	2	SKU
1405.910	255/355	32 x 33	90	505	2	8011578969165

new



## 1406 CRICCHETTO REVERSIBILE 1/4" - sgancio rapido RATCHET 1/4" REVERSIBLE - quick release

Model	140	25 x 29	75	186	2	SKU
1406.010	140	25 x 29	75	186	2	8011578940089



## 1407 CRICCHETTO DOPPIO 1/4" FEMMINA ESAGONO PER INSERTI - 1/4" MASCHIO QUADRO PER BUSSOLE DOUBLE RATCHET EXAGONAL FEMALE BITS 1/4" - 1/4" SQUARE MALE FOR SOCKETS

1/4"



Model	100	110	6	SKU
1407.010	100	110	6	8011578964924

new

**1408**

**PROLUNGA 1/4" - acciaio chrom-vanadium finitura cromata**  
**EXTENSION BAR 1/4" - chrom-vanadium steel chrome plated finish**

1/4"

DIN 3122 ISO 3315

				
<b>1408.075</b>	75	33	<b>6</b>	8011578929473
<b>1408.150</b>	150	66	<b>6</b>	8011578929503



**1410**

**LEVA A "T" 1/4" - acciaio chrom-vanadium finitura cromata**  
**SLIDING "T" BAR 1/4" - chrom-vanadium steel chrome plated finish**

1/4"

DIN 3322 ISO 3315

				
<b>1410.010</b>	115	44	<b>6</b>	8011578929534



**1412**

**SNODO CARDANICO 1/4" - acciaio chrom-vanadium finitura cromata**  
**UNIVERSAL JOINT 1/4" - chrom-vanadium steel chrome plated finish**

1/4"

DIN 3123 ISO 3316

				
<b>1412.010</b>	41	26	<b>6</b>	8011578929565



**1414**

**IMPUGNATURA PORTA BUSSOLE 1/4" - acciaio chrom-vanadium finitura cromata impugnatura plastica**  
**HANDLE FOR SOCKET 1/4" - chrom-vanadium steel chrome plated finish - plastic handle**

1/4"

DIN 3122 ISO 3315

				
<b>1414.010</b>	60	67	<b>2</b>	8011578929596



**1420**

**ADATTATORE 1/4" PORTAINSERI UNIVERSALE ESAGONO 1/4" (giraviti-esagoni-torx) - acc. chrom-vanadium fin. cromata**  
**ADAPTER COUPLER 1/4" FOR HEXAGON BIT 1/4" (screwdriver-hexagon-torx) - chrom-vanadium steel chrome plated finish**

1/4"

				
<b>1420.010</b>	26	14	<b>6</b>	8011578929626



**1425**

**RACCORDO AUMENTATORE DA 1/4" F A 3/8" M**  
**ADAPTER FROM 1/4" FEMALE TO 3/8" MALE**

1/4" 3/8"

DIN 3123







			
<b>1425.010</b>	20	<b>6</b>	8011578929657



**1430**

**CHIAVE A BUSSOLE 1/4" - intaglio**  
**SOCKET 1/4" - flat**

1/4"

					
<b>1430.300</b>	<b>3</b>	33	12	<b>6</b>	8011578937386
<b>1430.400</b>	<b>4</b>	33	13	<b>6</b>	8011578937409
<b>1430.500</b>	<b>5</b>	33	13	<b>6</b>	8011578937423
<b>1430.600</b>	<b>6</b>	33	13	<b>6</b>	8011578937447





**1432** CHIAVE A BUSSOLA 1/4" - phillips  
 SOCKET 1/4" - phillips



1/4"

1432.100	PH 1	33	13 6	8011578937461
1432.200	PH 2	33	14 6	8011578937485
1432.300	PH 3	33	14 6	8011578937508

**1436** CHIAVE A BUSSOLA 1/4" - esagonale maschio  
 SOCKET 1/4" - hexagon male



1/4"

1436.030	3	33	13 6	8011578937584
1436.040	4	33	13 6	8011578937607
1436.050	5	33	14 6	8011578937621
1436.060	6	33	15 6	8011578937645
1436.080	8	33	17 6	8011578937669

**1434** CHIAVE A BUSSOLA 1/4" - pozidriv  
 SOCKET 1/4" - pozidriv



1/4"

1434.100	PZ 1	33	13 6	8011578937522
1434.200	PZ 2	33	14 6	8011578937546
1434.300	PZ 3	33	14 6	8011578937560

**1438** CHIAVE A BUSSOLA 1/4" - torx con foro  
 SOCKET 1/4" - torx with hole



1/4"

1438.080	TX 8	33	12 6	8011578937683
1438.100	TX 10	33	13 6	8011578937706
1438.150	TX 15	33	13 6	8011578937720
1438.200	TX 20	33	14 6	8011578937744
1438.250	TX 25	33	14 6	8011578937768
1438.270	TX 27	33	13 6	8011578937782
1438.300	TX 30	33	14 6	8011578937805
1438.400	TX 40	33	14 6	8011578937829

**1440** CASSETTA 33 BUSSOLE 1/4" - MM 4 ÷ 13 - metallo  
 METAL BOX 33 SOCKETS 1/4" MM 4 ÷ 13 - metal

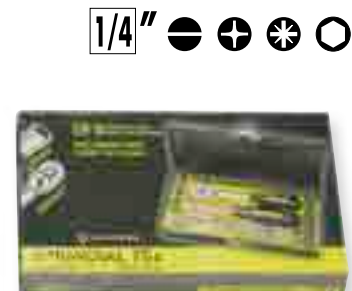

1/4"

Contenuto - content:

1400.040 4	1400.110 11	1430.300 3	1436.050 5
1400.045 4,5	1400.120 12	1430.400 4	1436.060 6
1400.050 5	1400.130 13	1430.500 5	1436.080 8
1400.055 5,5	1405.010 140	1430.600 6	0355.015 1,5
1400.060 6	1408.075 75	1430.700 7	0355.020 2
1400.070 7	1408.150 150	1432.100 1	0355.030 3
1400.080 8	1410.010 115	1432.200 2	
1400.090 9	1412.010	1436.030 3	
1400.100 10	1414.010	1436.040 4	

1440.010	245 x 120 x 40	1200	8011578960520

**1442** VALIGETTA 46 BUSSOLE 1/4" - plastica  
 BLOW CASE 46 SOCKETS 1/4" - plastic



1/4"

Contenuto-content:

1400.040	1400.120	1436.030	1432.200	1438.400
1400.045	1400.130	1436.040	1432.300	0345.012
1400.050	1400.140	1436.050	1434.100	0345.015
1400.055	1406.010	1436.060	1434.200	0345.020
1400.060	1408.075	1436.070	1434.300	0345.025
1400.070	1408.150	1436.080	1438.100	0241.014
1400.080	1414.010	1430.400	1438.150	
1400.090	1410.010	1430.500	1438.200	
1400.100	1412.010	1430.600	1438.250	
1400.110	1408.910	1432.100	1438.300	









1442.010	235 x 170 x 50	1318	8011578002107

**1450** CHIAVE A BUSSOLA  $\frac{3}{8}$ " BOCCA ESAGONALE FLANK DRIVE - acciaio chrom-vanadium finitura cromata  
SOCKET  $\frac{3}{8}$ " HEXAGON FLANK DRIVE SECTION - chrom-vanadium steel chrome plated finish

**3/8"**



DIN 3124 ISO 2725



Icona	●	⊥	⊥	⊥	⊥	⊥	Barcode
							
<b>1450.060</b>	<b>6</b>	25	9,8	17	20	<b>6</b>	8011578929718
<b>1450.070</b>	<b>7</b>	25	10,8	17	20	<b>6</b>	8011578929749
<b>1450.080</b>	<b>8</b>	25	12,3	17	20	<b>6</b>	8011578929770
<b>1450.090</b>	<b>9</b>	25	13,5	17	23	<b>6</b>	8011578929800
<b>1450.100</b>	<b>10</b>	25	14,5	17	23	<b>6</b>	8011578929831
<b>1450.110</b>	<b>11</b>	25	15,5	17	25	<b>6</b>	8011578929862
<b>1450.120</b>	<b>12</b>	25	16,0	17	24	<b>6</b>	8011578929893
<b>1450.130</b>	<b>13</b>	25	18,0	17	26	<b>6</b>	8011578929923
<b>1450.140</b>	<b>14</b>	28	19,8	18	31	<b>6</b>	8011578929954
<b>1450.150</b>	<b>15</b>	28	21,8	18	40	<b>6</b>	8011578929985
<b>1450.160</b>	<b>16</b>	28	21,8	20	36	<b>6</b>	8011578930011
<b>1450.170</b>	<b>17</b>	30	23,8	20	48	<b>6</b>	8011578930042
<b>1450.180</b>	<b>18</b>	30	25,0	21	62	<b>6</b>	8011578930073
<b>1450.190</b>	<b>19</b>	30	26,0	21	56	<b>6</b>	8011578930103
<b>1450.200</b>	<b>20</b>	30	27,8	23	65	<b>6</b>	8011578930134
<b>1450.210</b>	<b>21</b>	32	27,8	23	65	<b>6</b>	8011578930165
<b>1450.220</b>	<b>22</b>	32	29,8	26	81	<b>6</b>	8011578930196

**1455** CRICCHETTO REVERSIBILE  $\frac{3}{8}$ " CON SGANCIO RAPIDO - acciaio chrom-vanadium finitura cromata - impugnatura plastica  
RATCHET  $\frac{3}{8}$ " REVERSIBLE QUICK RELEASE - chrom-vanadium steel chrome plated finish - plastic handle

**3/8"**



DIN 3122 ISO 3315

Icona	⊥	⊥	⊥	⊥	⊥	Barcode
						
<b>1455.010</b>	196	31 x 31,2	82	250	<b>2</b>	8011578930226

**1458** PROLUNGA  $\frac{3}{8}$ " - acciaio chrom-vanadium finitura cromata  
EXTENSION BAR  $\frac{3}{8}$ " - chrom-vanadium steel chrome plated finish

**3/8"**

DIN 3123 ISO 3316

Icona	⊥	⊥	⊥	⊥	Barcode
					
<b>1458.075</b>	75		76	<b>6</b>	8011578930257
<b>1458.150</b>	150		138	<b>6</b>	8011578930288



**1460** LEVA A "T"  $\frac{3}{8}$ " - acciaio chrom-vanadium finitura cromata  
SLIDING "T" BAR  $\frac{3}{8}$ " - chrom-vanadium steel chrome plated finish

**3/8"**

DIN 3122 ISO 3315

Icona	⊥	⊥	⊥	⊥	Barcode
					
<b>1460.010</b>	165		154	<b>6</b>	8011578930318



**1462** SNODO CARDANICO  $\frac{3}{8}$ " - acciaio chrom-vanadium finitura cromata  
UNIVERSAL JOINT  $\frac{3}{8}$ " - chrom-vanadium steel chrome plated finish

**3/8"**

DIN 3123 ISO 3316

Icona	⊥	⊥	⊥	⊥	Barcode
					
<b>1462.010</b>	57		69	<b>6</b>	8011578930349



**1470**
**ADATTATORE 3/8" PORTAINERTI UNIVERSALE ESAGONO 1/4" (giraviti-esagoni-torx) - acc. chrom-vanadium fin. cromata**  
**ADAPTER COUPLER 3/8" FOR HEXAGON BIT 1/4" (screwdriver-hexagon-torx) - chrom-vanadium steel chrome plated finish**
**3/8"**

1470.010



29



24



6



801157811000004

**1475**
**RACCORDO DA 3/8" FEMMINA A MASCHIO - acciaio chrom-vanadium finitura cromata**  
**ADAPTER FROM 3/8" FEMALE TO MALE - chrom-vanadium steel chrome plated finish**
**3/8"**

DIN 3123 ISO 3316



1475.010



1/4" Maschio-Male riduttore/reduction



31



6



8011578930400

1475.020

1/2" Maschio-Male aumento/increase

51

6

8011578930431

**1477**
**CHIAVE A BUSSOLA 3/8" PER CANDELE BOCCA ESAGONALE PROFILO FLANK DRIVE - acc. chrom-vanadium fin. cromata**  
**SOCKET 3/8" FOR SPARK PLUNG HEXAGON FLANK DRIVE SECTION - chrom-vanadium steel chrome plated finish**
**3/8"**

1477.160



16



65



22



96



6



8011578930462

1477.210

21

65

28

143

6

8011578930493

**1490**
**CASSETTA 22 BUSSOLE E ACCESSORI 3/8" - metallo**  
**METAL BOX 22 SOCKETS AND ACCESSORIES 3/8" - metal**
**3/8"**

Contenuto-content:

1450.060 6  
 1450.070 7  
 1450.080 8  
 1450.090 9  
 1450.100 10  
 1450.110 11  
 1450.120 12  
 1450.130 13  
 1450.140 14  
 1450.150 15  
 1450.160 16  
 1450.170 17  
 1450.180 18  
 1450.190 19  
 1450.220 22  
 1455.010  
 1458.075  
 1458.150  
 1460.010  
 1462.010  
 1477.160  
 1477.210



1490.010



320 x 150 x 50



2300



8011578960544

**1500**

CHIAVE A BUSSOLA 1/2" BOCCA ESAGONALE PROFILO FLANK DRIVE - acciaio chrom-vanadium finitura cromata  
SOCKET 1/2" HEXAGON FLANK DRIVE SECTION - chrom-vanadium steel chrome plated finish

DIN 3124 ISO 2725

Icona	Numero	Ø	L	L2	L3	L4	Materiali	Barcode	Numero
	1500.080	8	38	13,0	22	48	6	8011578942786	8011578942786
	1500.090	9	38	14,0	22	48	6	8011578942809	8011578942809
	1500.100	10	38	15,0	22	48	6	8011578930585	8011578930585
	1500.110	11	38	16,8	22	50	6	8011578930615	8011578930615
	1500.120	12	38	17,9	22	52	6	8011578930646	8011578930646
	1500.130	13	38	18,7	22	52	6	8011578930677	8011578930677
	1500.140	14	38	20,0	22	55	6	8011578930707	8011578930707
	1500.150	15	38	21,8	21	56	6	8011578930738	8011578930738
	1500.160	16	38	22,0	21	49	6	8011578930769	8011578930769
	1500.170	17	38	23,0	22	63	6	8011578930790	8011578930790
	1500.180	18	38	25,8	24	76	6	8011578930820	8011578930820
	1500.190	19	38	25,8	24	67	6	8011578930851	8011578930851
	1500.200	20	38	27,8	26	87	6	8011578930882	8011578930882
	1500.210	21	38	29,3	26	82	6	8011578930912	8011578930912
	1500.220	22	38	30,0	28	96	6	8011578930943	8011578930943
	1500.230	23	38	31,7	29	113	6	8011578930974	8011578930974
	1500.240	24	38	32,0	29	105	6	8011578931001	8011578931001
	1500.250	25	42	34,0	31	138	6	8011578931032	8011578931032
	1500.260	26	42	35,0	33	133	6	8011578931063	8011578931063
	1500.270	27	42	36,0	31	150	6	8011578931094	8011578931094
	1500.280	28	42	38,0	34	176	6	8011578931124	8011578931124
	1500.300	30	42	38,0	34	188	6	8011578931155	8011578931155
	1500.320	32	42	42,0	38	210	6	8011578931186	8011578931186

1/2"



**1500Z**

SERIE 10 CHIAVI A BUSSOLA 1/2" - binario  
SET 10 SOCKETS 1/2" - holding bar

Contenuto-content:

1500.080	1500.100	1500.120	1500.150	1500.190
1500.090	1500.110	1500.130	1500.170	1500.220

1/2"

Icona	Numero	Materiali	Barcode	Numero
	1500.910	606	8011578944902	8011578944902



**1500ZZ**

BINARIO PER BUSSOLE 1/2" - mm. 260 - vuoto  
HOL. BAR FOR SOCKETS 1/2" - mm. 260 - empty

1/2"

Icona	Numero	Materiali	Barcode	Numero
	1500.990	260	8011578944889	8011578944889



**1501**

CHIAVE A BUSSOLA 1/2" BOCCA POLIGONALE - acciaio chrom-vanadium finitura cromata  
SOCKET 1/2" BIHEXAGONAL - chrom-vanadium steel chrome plated finish

DIN 3124 ISO 2725

Icona	Numero	Ø	L	L2	L3	L4	Materiali	Barcode	Numero
	1501.080	8	38	13,0	22	48	6	8011578964948	8011578964948
	1501.090	9	38	14,0	22	48	6	8011578964962	8011578964962
	1501.100	10	38	15,0	22	48	6	8011578964986	8011578964986
	1501.110	11	38	16,8	22	50	6	8011578965006	8011578965006
	1501.120	12	38	17,9	22	52	6	8011578965020	8011578965020
	1501.130	13	38	18,7	22	52	6	8011578965044	8011578965044
	1501.140	14	38	20,0	22	55	6	8011578965068	8011578965068
	1501.150	15	38	21,8	21	56	6	8011578965082	8011578965082
	1501.160	16	38	22,0	21	49	6	8011578965105	8011578965105
	1501.170	17	38	23,0	22	63	6	8011578965129	8011578965129
	1501.180	18	38	25,8	24	76	6	8011578965143	8011578965143
	1501.190	19	38	25,8	24	67	6	8011578965167	8011578965167
	1501.210	21	38	29,3	26	82	6	8011578965181	8011578965181
	1501.220	22	38	30,0	28	96	6	8011578965204	8011578965204
	1501.240	24	38	32,0	29	105	6	8011578965228	8011578965228
	1501.270	27	42	36,0	31	150	6	8011578965242	8011578965242
	1501.300	30	42	38,0	34	188	6	8011578965266	8011578965266
	1501.320	32	42	42,0	38	210	6	8011578965280	8011578965280

1/2"



POLIGONALE  
BIHEXAGONAL

new  
new  
new  
new  
new  
new  
new  
new  
new  
new  
new  
new  
new  
new  
new  
new

# 1501Z

## SERIE 10 CHIAVI A BUSSOLA POLIGONALI 1/2" - binario SET 10 POLYGONAL SOCKETS 1/2" - holding bar

1/2"

Contenuto-content:

1500.080 1500.100 1500.120 1500.150 1500.190  
 1500.090 1500.110 1500.130 1500.170 1500.220



1501.910



606



8011578965303

# 1502

## CHIAVE A BUSSOLA 1/2" LUNGA SOCKET 1/2" DEEP



Model	Size	Key	Length	Width	Weight	Count	Part No.
1502.100	10	77	22	16	84	6	8011578940140
1502.110	11	77	22	16	90	6	8011578940164
1502.120	12	77	22	18	98	6	8011578940188
1502.130	13	77	22	19	107	6	8011578940201
1502.140	14	77	22	21	110	6	8011578940225
1502.150	15	77	22	22	120	6	8011578940249
1502.160	16	77	22	22	109	6	8011578940263
1502.170	17	77	24	24	142	6	8011578960506
1502.180	18	77	26	26	178	6	8011578940300
1502.190	19	77	26	26	163	6	8011578940324
1502.210	21	77	28	28	187	6	8011578940362
1502.220	22	77	30	30	227	6	8011578940386
1502.240	24	77	32	32	253	6	8011578940409
1502.270	27	77	36	36	340	6	8011578940423
1502.300	30	77	40	40	425	6	8011578940447
1502.320	32	77	42	42	452	6	8011578940461

1/2"



# 1502Z

## SERIE 10 CHIAVI A BUS. LUNGHE 1/2" - binario SET 10 SOCKETS 1/2" LONG - holding bar

1/2"

Contenuto-content:

1502.100 1502.120 1502.140 1502.170 1502.220  
 1502.110 1502.130 1502.150 1502.190 1502.240



1502.910



1426



8011578944926

# 1504

## CHIAVE A BUSSOLA 1/2" BOCCA POLIGONALE in POLLICI - acciaio chrom-vanadium finitura cromata SOCKET 1/2" POLYGONAL in INCH - chrom-vanadium steel chrome plated finish

DIN 3124 ISO 2725



Model	Size	Key	Length	Weight	Count	Part No.	Status
1504.010	3/8"	38	48	6	8011578962166		new
1504.020	7/16"	38	48	6	8011578962180		new
1504.030	1/2"	38	54	6	8011578962203		new
1504.040	9/16"	38	52	6	8011578962227		new
1504.050	5/8"	38	48	6	8011578962241		new
1504.060	19/32"	38	52	6	8011578962265		new
1504.070	11/16"	38	60	6	8011578962289		new
1504.080	3/4"	38	64	6	8011578962302		new
1504.090	25/32"	38	76	6	8011578962326		new
1504.100	13/16"	38	78	6	8011578962340		new
1504.110	7/8"	38	90	6	8011578962364		new
1504.120	15/16"	38	104	6	8011578962388		new
1504.130	1"	42	132	6	8011578962401		new
1504.140	1.1/16"	42	130	6	8011578962425		new
1504.150	1.1/8"	42	156	6	8011578962449		new
1504.160	1.3/16"	42	184	6	8011578962463		new
1504.170	1.1/4"	42	202	6	8011578962487		new

1/2"

POLLICI  
 INCH



**1504Z** SERIE 17 CHIAVI A BUSSOLA 1/2" in POLLICI - binario  
 SET 17 SOCKETS 1/2" in INCH - holding bar

1/2"

POLLICI  
 INCH

Contenuto-content:

1504.010	1504.020	1504.030	1504.040	1504.050
1504.060	1504.070	1504.080	1504.090	1504.100
1504.110	1504.120	1504.130	1504.140	1504.150
1504.160	1504.170			

 1504.910

 1656







 8011578962500



**1505** CRICCHETTO REVERSIBILE 1/2" CON SGANCIO RAPIDO - acciaio chrom-vanadium finitura cromata - impugnatura plastica  
 RATCHET 1/2" REVERSIBLE QUICK RELEASE - chrom-vanadium steel chrome plated finish - plastic handle

1/2"







DIN 3122 ISO 3315

 1505.010  254  41,5 x 39  96  563  2  8011578931216



**1505Z** CRICCHETTO REVERSIBILE 1/2" TELESCOPICO - SNODATO - acciaio chrom-vanadium finitura cromata  
 RATCHET 1/2" REVERSIBLE TELESCOPIC - FLEX - chrom-vanadium steel chrome plated finish

1/2"







 1505.910  340/480  43 x 42  110  1160  2  8011578967543

new



**1506** CRICCHETTO REVERSIBILE 1/2" - sgancio rapido  
 RATCHET 1/2" REVERSIBLE - quick release

1/2"

 1506.010  254  38 x 43  105  560  2  8011578940102



**1508** PROLUNGA 1/2" - acciaio chrom-vanadium finitura cromata  
 EXTENSION BAR 1/2" - chrom-vanadium steel chrome plated finish

1/2"

DIN 3123 ISO 3316

 1508.125  125  197  6  8011578931247  
 1508.250  250  388  6  8011578931278



**1509**
**PROLUNGA 1/2" ESTREMITÀ SFERICA INCLINABILE - acciaio chrom-vanadium finitura cromata**  
**EXTENSION BAR 1/2" WOBBLE SPHERIC - chrom-vanadium steel chrome plated finish**
**1/2"**

	← L →			
<b>1509.125</b>	125	215	<b>6</b>	8011578931308
<b>1509.250</b>	250	417	<b>6</b>	8011578931339

**1510**
**LEVA A "T" 1/2" - acciaio chrom-vanadium finitura cromata**  
**SLIDING "T" BAR 1/2" - chrom-vanadium steel chrome plated finish**
**1/2"**

DIN 3122	ISO 3315			
	← L →			
<b>1510.010</b>	250	360	<b>6</b>	8011578931360





**1512**
**SNODO CARDANICO 1/2" - acciaio chrom-vanadium finitura cromata**  
**UNIVERSAL JOINT 1/2" - chrom-vanadium steel chrome plated finish**
**1/2"**

DIN 3123	ISO 3316			
	← L →			
<b>1512.010</b>	70	137	<b>6</b>	8011578931391







**1520**
**ADATTATORE 1/2" PORTAINSERITI UNIVERSALE ESAGONO 1/4" (giraviti-esagoni-torx) - acc. chrom-vanadium fin. cromata**  
**ADAPTER COUPLER 1/2" FOR HEXAGON BIT 1/4" (screwdriver-hexagon-torx) - chrom-vanadium steel chrome plated finish**
**1/2"**

				
<b>1520.010</b>		52	<b>6</b>	8011578949563

**1525**
**RACCORDO DA 1/2" FEMMINA - MASCHIO - acciaio chrom-vanadium finitura cromata**  
**ADAPTER FROM 1/2" FEMALE - MALE - chrom-vanadium steel chrome plated finish**
**1/2"**

DIN 3123	ISO 3316			
	← L →			
<b>1525.010</b>	3/8" Maschio-Male riduttore/reduction	50	<b>6</b>	8011578931421
<b>1525.015</b>	3/4" Maschio-Male aumento/increase	142	<b>6</b>	8011578943004

**1527**
**CHIAVE A BUSSOLA 1/2" PER CANDELE BOCCA ESAGONALE PROFILO FLANK DRIVE - acc. chrom-vanadium fin. cromata**  
**SOCKET 1/2" FOR SPARK PLUNG HEXAGON FLANK DRIVE SECTION - chrom-vanadium steel chrome plated finish**
**1/2"**

						
<b>1527.160</b>	<b>16</b>	65	22	94	<b>6</b>	8011578931452
<b>1527.210</b>	<b>21</b>	65	28	141	<b>6</b>	8011578931483

**1530** CHIAVE A BUSSOLA 1/2" - esagonale maschio  
 SOCKET 1/2" - hexagon male



1/2"

Model	Size	Length	Weight	Material	Barcode
1530.040	4	55	81	6	8011578937843
1530.050	5	55	85	6	8011578937867
1530.060	6	55	79	6	8011578937881
1530.080	8	55	87	6	8011578937904
1530.100	10	55	91	6	8011578937928
1530.120	12	55	101	6	8011578937942
1530.140	14	55	114	6	8011578937966
1530.170	17	55	149	6	8011578937980
1530.190	19	55	157	6	8011578938000

**1530Z** SERIE 9 BUSSOLE ESAGONO 1/2" - binario  
 SET 9 SOCKETS HEX. 1/2" - holding bar



1/2"

Contenuto-content:

1530.040	1530.060	1530.100	1530.140	1530.190
1530.050	1530.080	1530.120	1530.170	

Model	Weight	Barcode
1530.909	970	8011578944940

**1531** CHIAVE A BUSS. 1/2" ESAG. MASCHIO - lunga  
 SOCKET 1/2" HEX MALE - deep



1/2"

Model	Size	Length	Weight	Material	Barcode
1531.050	5	90	108	6	8011578941086
1531.060	6	90	110	6	8011578941109
1531.080	8	90	113	6	8011578941123
1531.100	10	90	114	6	8011578941147

**1531A** CHIAVE A BUSSOLA 1/2" ESAGONO  
 SOCKET 1/2" HEXAGON



1/2"

Model	Size	Length	Weight	Material	Barcode
1531.205	5	140	141	6	8011578944964
1531.206	6	140	141	6	8011578944988
1531.208	8	140	144	6	8011578945008
1531.210	10	140	147	6	8011578945022

**1532** CHIAVE A BUSSOLA 1/2" ESAGONO SFERICO  
 SOCKET 1/2" HEXAGON BALL POINT



1/2"

Model	Size	Length	Weight	Material	Barcode
1532.050	5	90	107	6	8011578945046
1532.060	6	90	108	6	8011578945060
1532.080	8	90	111	6	8011578945084

**1532Z** SERIE 10 BUSS. ESAG. LUNGHE 1/2" - binario  
 SET 10 SOCKETS HEX. DEEP 1/2" - holding bar



1/2"

Contenuto-content:

1531.050	1531.080	1531.206	1531.210	1532.060
1531.060	1531.205	1531.208	1532.050	1532.080

Model	Weight	Barcode
1532.990	1260	8011578945107



# 1534

**CHIAVE A BUSSOLA 1/2" - torx**  
**SOCKET 1/2" - torx**

1/2"



Icona	Modello	Spessore	Lunghezza	Materiali	Quantità	Barcode	Numero
	1534.200	<b>TX 20</b>	56	81	<b>6</b>		8011578938024
	1534.250	<b>TX 25</b>	56	82	<b>6</b>		8011578938048
	1534.270	<b>TX 27</b>	56	82	<b>6</b>		8011578938062
	1534.300	<b>TX 30</b>	56	82	<b>6</b>		8011578938086
	1534.400	<b>TX 40</b>	56	68	<b>6</b>		8011578938109
	1534.450	<b>TX 45</b>	56	84	<b>6</b>		8011578938123
	1534.500	<b>TX 50</b>	56	84	<b>6</b>		8011578938147

# 1534T

**CHIAVE A BUSSOLA 1/2" TX CON FORO**  
**SOCKET 1/2" TORX WITH HOLE**

1/2"



Icona	Modello	Modello	Spessore	Lunghezza	Materiali	Quantità	Barcode	Numero
	1534.840	<b>TX 40</b>	90	109	<b>6</b>		8011578945145	
	1534.845	<b>TX 45</b>	90	110	<b>6</b>		8011578945169	
	1534.850	<b>TX 50</b>	90	110	<b>6</b>		8011578945183	
	1534.855	<b>TX 55</b>	90	112	<b>6</b>		8011578945206	
	1534.860	<b>TX 60</b>	90	131	<b>6</b>		8011578945220	
	1534.870	<b>TX 70</b>	90	152	<b>6</b>		8011578945244	

# 1534A

**SERIE 7 BUS. TX CON FORO 1/2" - binario**  
**SET 7 SOCK. TORX WITH HOLE 1/2" - hold. bar**

1/2"



Contenuto-content:

1534.200 1534.270 1534.400 1534.500  
 1534.250 1534.300 1534.450

Icona	Modello	Materiali	Quantità	Barcode	Numero
	1534.797		496		8011578945121

# 1534Z

**CHIAVE A BUSSOLA 1/2" TX CON FORO**  
**SOCKET 1/2" TORX WITH HOLE**

1/2"



Icona	Modello	Modello	Spessore	Lunghezza	Materiali	Quantità	Barcode	Numero
	1534.940	<b>TX 40</b>	140	142	<b>6</b>		8011578945268	
	1534.945	<b>TX 45</b>	140	142	<b>6</b>		8011578945282	
	1534.950	<b>TX 50</b>	140	143	<b>6</b>		8011578945305	
	1534.955	<b>TX 55</b>	140	145	<b>6</b>		8011578945329	

# 1534TZ

**SERIE 10 BUSSOLE TORX LUNGHE 1/2" - binario**  
**SET 10 TORX SOCKETS - DEEP 1/2" - holding bar**

1/2"

Contenuto-content:

1534.840 1534.850 1534.860 1534.940 1534.950  
 1534.845 1534.855 1534.870 1534.945 1534.955

Icona	Modello	Materiali	Quantità	Barcode	Numero
	1534.990		1328		8011578945343



# 1535

**CHIAVE A BUSSOLA 1/2" TORX E FEMMINA**  
**SOCKET 1/2" TORX AND FEMALE**

1/2"



Icona	Modello	Spessore	Lunghezza	Materiali	Quantità	Barcode	Numero
	1535.100	<b>E 10</b>	38	13,5	22	50	<b>6</b> 8011578940942
	1535.120	<b>E 12</b>	38	15,0	22	50	<b>6</b> 8011578940966
	1535.140	<b>E 14</b>	38	17,0	22	52	<b>6</b> 8011578940980
	1535.160	<b>E 16</b>	38	19,0	22	57	<b>6</b> 8011578941000
	1535.180	<b>E 18</b>	38	20,0	22	57	<b>6</b> 8011578941024
	1535.200	<b>E 20</b>	38	22,0	24	72	<b>6</b> 8011578941048
	1535.240	<b>E 24</b>	38	24,0	28	98	<b>6</b> 8011578941062

**1535Z** SERIE 7 CHIAVI A BUS. TORX 1/2" - binario  
 SET 7 TORX SOCKETS 1/2" - holding bar



1/2"

Contenuto-content:

1535.100 1535.140 1535.180 1535.240  
 1535.120 1535.160 1535.200







 **1535.907**

 472  8011578945367

**1538** CHIAVE A BUSSOLA 1/2" RIBE  
 SOCKET 1/2" RIBE









1/2"

					
<b>1538.060</b>	<b>6</b>	55	84	<b>6</b>	8011578945503
<b>1538.070</b>	<b>7</b>	55	85	<b>6</b>	8011578945527
<b>1538.080</b>	<b>8</b>	55	85	<b>6</b>	8011578945541
<b>1538.100</b>	<b>10</b>	55	88	<b>6</b>	8011578945565
<b>1538.120</b>	<b>12</b>	55	98	<b>6</b>	8011578945589

**1537** CHIAVE A BUSSOLA 1/2" XZN SPLINE  
 SOCKET 1/2" XZN SPLINE



1/2"

					
<b>1537.040</b>	<b>M 4</b>	55	83	<b>6</b>	8011578945381
<b>1537.050</b>	<b>M 5</b>	55	84	<b>6</b>	8011578945404
<b>1537.060</b>	<b>M 6</b>	55	85	<b>6</b>	8011578945428
<b>1537.080</b>	<b>M 8</b>	55	86	<b>6</b>	8011578945442
<b>1537.100</b>	<b>M 10</b>	55	88	<b>6</b>	8011578945466
<b>1537.120</b>	<b>M 12</b>	55	98	<b>6</b>	8011578945480

**1538Z** SERIE 10 BUSSOLE XZN RIBE 1/2" - binario  
 SET 10 XZN RIBE SOCKETS 1/2" - holding bar



1/2"

Contenuto-content:

1537.040 1537.060 1537.100 1538.060 1538.080  
 1537.050 1537.080 1537.120 1538.070 1538.100

 **1538.797**  895  8011578945602

**1542** SERIE 12 CHIAVI A BUSSOLA 1/2" + CRICCHETTO + PROLUNGA  
 SET 12 SOCKETS 1/2" + RATCHET + EXTENSION



Contenuto - content:

1500.100  
 1500.110  
 1500.120  
 1500.130  
 1500.140  
 1500.150  
 1500.170  
 1500.190  
 1500.220  
 1500.240  
 1506.010  
 1508.125

 **1542.010**  12  1580  8011578963163

new

## 1545 CASSETTA 25 BUSSOLE E ACCESSORI 1/2" - metallo



METAL BOX 25 SOCKETS AND ACCESSORIES 1/2" - metal

Contenuto - content:

1500.080 8  
 1500.090 9  
 1500.100 10  
 1500.110 11  
 1500.120 12  
 1500.130 13  
 1500.140 14  
 1500.150 15  
 1500.160 16  
 1500.170 17  
 1500.180 18  
 1500.190 19  
 1500.210 21  
 1500.220 22  
 1500.240 24  
 1500.270 27  
 1500.300 30  
 1500.320 32  
 1505.010 254  
 1508.125 125  
 1508.250 250  
 1510.010 250  
 1512.010  
 1527.160 16  
 1527.210 21

1/2"



	←-L-→		
<b>1545.010</b>	355 x 190 x 50	5100	8011578003722
<b>1545.910</b>	355 x 190 x 50 pollici-inch	5100	8011578970482

## 1548 VALIGETTA 22 BUSSOLE 1/2" - plastica

BLOW CASE 22 SOCKETS 1/2" - plastic

1/2"

Contenuto-content:

1500.100  
 1500.110  
 1500.120  
 1500.130  
 1500.140  
 1500.150  
 1500.160  
 1500.170  
 1500.180  
 1500.190  
 1500.220  
 1500.240  
 1500.270  
 1500.300  
 1500.320  
 1506.010  
 1508.125  
 1508.250  
 1512.010  
 1510.910  
 1527.160  
 1527.210



	←-L-→		
<b>1548.010</b>	320 x 290 x 70	3800	8011578003746



**1555 VALIGETTA 94 BUSSOLE E ACCESSORI 1/4" - 1/2" - plastica**  
 BLOW CASE 94 SOCKETS AND ACCESSORIES 1/4" - 1/2" - plastic

Contenuto - content:

1400.040	1436.030	1500.200	0251.400
1400.045	1436.040	1500.210	0253.400
1400.050	1436.050	1500.220	0253.450
1400.055	1436.060	1500.230	0253.500
1400.060	1430.400	1500.240	0253.550
1400.070	1430.550	1500.270	0345.015
1400.080	1430.600	1500.300	0345.020
1400.090	1430.700	1500.320	0345.025
1400.100	1432.100	1502.140	1527.160
1400.110	1432.200	1502.150	1527.210
1400.120	1434.100	1502.170	
1400.130	1434.200	1502.190	
1400.140	1438.080	1505.010	
1402.060	1438.100	1508.125	
1402.070	1438.150	1508.250	
1402.080	1438.200	1512.010	
1402.090	1438.250	1510.010	
1402.100	1438.300	1520.010	
1402.110	1500.100	0263.080	
1402.120	1500.110	0263.100	
1402.130	1500.120	0263.120	
1405.010	1500.130	0263.140	
1408.075	1500.140	0249.080	
1408.150	1500.150	0249.100	
1408.000	1500.160	0249.120	
1414.010	1500.170	0250.300	
1410.010	1500.180	0250.400	
1412.010	1500.190	0251.300	

1/4" 1/2"



**1555.010** 380 x 320 x 80



5650



8011578003807

**1557 VALIGETTA 88 BUSSOLE - CHIAVI COMBINATE - CHIAVI MASCHIO - plastica**  
 BLOW CASE 88 SOCKETS - COMBINATION WRENCHES - HEX KEYS - plastic

Contenuto - content:

0350.020	1400.120	1500.140	0251.400
0350.025	1400.130	1500.150	0253.400
0350.030	1400.140	1500.160	0253.450
0350.040	1405.010	1500.170	0253.500
0350.050	1408.075	1500.180	0253.550
0350.060	1408.150	1500.190	1527.160
1030.080	1408.000	1500.200	1527.210
1030.100	1414.010	1500.220	
1030.110	1410.010	1500.240	
1030.120	1412.010	1500.270	
1030.130	1436.300	1500.300	
1030.140	1436.400	1500.320	
1030.150	1436.500	1505.010	
1030.170	1436.600	1508.125	
1030.190	1430.400	1508.250	
1030.220	1430.500	1512.010	
1520.010	1430.600	1510.010	
1400.040	1432.100	0263.080	
1400.045	1432.200	0263.100	
1400.050	1434.100	0263.120	
1400.055	1434.200	0263.140	
1400.060	1438.080	0249.080	
1400.070	1438.100	0249.100	
1400.080	1438.150	0249.120	
1400.090	1438.200	0250.300	
1400.100	1438.250	0250.400	
1400.110	1438.300	0251.300	

1/4" 1/2"



**1557.010** 380x320x80



6150



8011578966003

new

**1560**
**VALIGETTA 56 UTENSILI VARI: CHIAVI - CACCIAVITI - PINZE - BUSSOLE - plastica**  
**BLOW CASE 56 TOOLS: WRENCHES - SCREWDRIVERS - PLIERS - SOCKETS - plastic**
1/4" 1/2"

Contenuto - content:

0170.610	0253.100	1508.125
0170.503	0253.150	1512.010
0172.610	0253.200	1527.160
0172.615	0253.250	1527.210
0172.103	0253.270	
0377.040	0253.300	
0440.018	0253.400	
0490.024	1400.080	
1030.080	1400.090	
1030.100	1400.100	
1030.120	1400.110	
1030.130	1400.120	
1030.150	1400.130	
1030.170	1420.010	
0345.015	1414.010	
0345.020	1500.100	
0345.025	1500.110	
0345.030	1500.120	
0345.040	1500.130	
0250.100	1500.150	
0250.200	1500.170	
0250.300	1500.190	
0249.300	1500.220	
0249.400	1500.240	
0249.500	1500.270	
0249.600	1505.010	

**1560.010**

380x320x80



5300



8115781100004

8011578965822

**new****1570**
**ESPOSITORE 180 CHIAVI BUSSOLA E ACCESSORI 1/4" - 3/8" - 1/2" - metallo**  
**DISPLAY 180 SOCKETS AND ACCESSORIES 1/4" - 3/8" - 1/2" - metal**
1/4" 3/8" 1/2"

Contenuto - content:

1400.040	4	Nr. 3	1450.120	12	Nr. 3	1500.150	15	Nr. 2
1400.045	4,5	Nr. 3	1450.130	13	Nr. 3	1500.160	16	Nr. 2
1400.050	5	Nr. 3	1450.140	14	Nr. 2	1500.170	17	Nr. 2
1400.055	5,5	Nr. 3	1450.150	15	Nr. 2	1500.180	18	Nr. 2
1400.060	6	Nr. 3	1450.160	16	Nr. 2	1500.190	19	Nr. 2
1400.070	7	Nr. 3	1450.170	17	Nr. 2	1500.200	20	Nr. 2
1400.080	8	Nr. 3	1450.180	18	Nr. 2	1500.210	21	Nr. 2
1400.090	9	Nr. 3	1450.190	19	Nr. 2	1500.220	22	Nr. 2
1400.100	10	Nr. 3	1450.200	20	Nr. 2	1500.230	23	Nr. 2
1400.110	11	Nr. 3	1450.210	21	Nr. 2	1500.240	24	Nr. 2
1400.120	12	Nr. 3	1450.220	22	Nr. 2	1500.250	25	Nr. 2
1400.130	13	Nr. 3	1455.010		Nr. 2	1500.260	26	Nr. 2
1405.010		Nr. 2	1458.075		Nr. 2	1500.270	27	Nr. 2
1408.075		Nr. 2	1458.150		Nr. 2	1500.280	28	Nr. 2
1408.150		Nr. 2	1460.010		Nr. 2	1500.300	30	Nr. 2
1410.010		Nr. 2	1462.010		Nr. 2	1500.320	32	Nr. 2
1412.010		Nr. 2	1470.010		Nr. 2	1505.010		Nr. 2
1414.010		Nr. 2	1475.010		Nr. 2	1508.125		Nr. 2
1420.010		Nr. 2	1475.020		Nr. 2	1508.250		Nr. 2
1425.010		Nr. 2	1477.160		Nr. 2	1509.125		Nr. 2
1450.060	6	Nr. 3	1477.210		Nr. 2	1509.250		Nr. 2
1450.070	7	Nr. 3	1500.100	10	Nr. 3	1510.010		Nr. 2
1450.080	8	Nr. 3	1500.110	11	Nr. 3	1512.010		Nr. 2
1450.090	9	Nr. 3	1500.120	12	Nr. 3	1525.010		Nr. 2
1450.100	10	Nr. 3	1500.130	13	Nr. 3	1527.160		Nr. 2
1450.110	11	Nr. 3	1500.140	14	Nr. 2	1527.210		Nr. 2

**1570.010**

400 x 600



14500



8115781100004

8011578931605







**1570.210**

vuoto - empty

5000

8011578003753

**1600** CHIAVE A BUSSOLA 3/4"  
 SOCKET 3/4"

						
1600.220	22	51	32	36	212	2 8011578938161
1600.230	23	51	32	36	216	2 8011578938185
1600.240	24	50	34	36	218	2 8011578938208
1600.260	26	53	36	38	262	2 8011578938222
1600.270	27	53	36	38	224	2 8011578938246
1600.280	28	53	38	40	265	2 8011578938260
1600.300	30	54	38	42	282	2 8011578938284
1600.320	32	56	38	44	300	2 8011578938307
1600.330	33	56	38	46	333	2 8011578938321
1600.340	34	56	38	46	316	2 8011578938345
1600.360	36	58	42	50	424	2 8011578938369
1600.380	38	58	42	50	500	2 8011578938383
1600.410	41	64	45	56	574	2 8011578938406
1600.460	46	71	48	62	702	2 8011578938420
1600.500	50	73	48	68	794	2 8011578938444
1600.550	55	72	48	68	918	2 8011578938468
1600.600	60	75	49	74	1125	2 8011578938482

3/4"



**1605** CRICCHETTO REVERSIBILE 3/4" - sgancio rapido  
 RATCHET 3/4" - REVERSIBLE - quick release

				
1605.010	500	1936	1	8011578938505

3/4"



**1608** PROLUNGA 3/4"  
 EXTENSION BAR 3/4"

				
1608.100	100	800	2	8011578938529
1608.200	200	808	2	8011578938543
1608.400	400	1522	2	8011578938567

3/4"







**1610** LEVA A "T" 3/4"  
 SLIDING "T" BAR 3/4"

				
1610.010	460	1328	2	8011578942762

3/4"



**1612** SNODO CARDANICO 3/4"  
 UNIVERSAL JOINT 3/4"

				
1612.010	108	546	2	8011578938581

3/4"



**1625** ADATTATORE 3/4" F - 1/2" M  
 ADAPTERS 3/4" F - 1/2" M

				
1625.010	F 3/4"-M 1/2"	200	2	8011578938604

3/4" 1/2"



**1640** CASSETTA 14 BUSSOLE 3/4" - mm 22 ÷ 50 - metallo  
 METAL BOX 14 SOCKETS 3/4" - mm 22 ÷ 50 - metal

Contenuto-content:









1600.220	22	1600.320	32	1600.460	46	1608.100	100
1600.240	24	1600.360	36	1600.500	50	1608.200	200
1600.270	27	1600.380	38	1605.010			
1600.300	30	1600.410	41	1610.010			

			
1640.010	550 x 190 x 70	11900	8011578902216

3/4"





**1642** CHIAVE A BUSSOLA 1"  
 SOCKET 1"

							
1642.360	36	65	46	51	504	1	8011578944568
1642.410	41	70	45	57	624	1	8011578944582
1642.460	46	75	50	65	922	1	8011578944605
1642.500	50	75	56	70	1100	1	8011578944629
1642.550	55	80	56	76	1354	1	8011578944643
1642.600	60	88	57	82	1512	1	8011578944667
1642.650	65	88	56	88	1730	1	8011578944681
1642.700	70	94	68	94	2212	1	8011578944704
1642.750	75	98	68	100	2534	1	8011578944728
1642.800	80	104	68	105	2734	1	8011578944742

1"







**1645** CRICCHETTO 1"  
 RATCHET 1"

				
1645.010	665	4374	1	8011578944766

1"

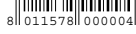

**1646** LEVA A "T" 1"  
 SLIDING "T" BAR 1"

				
1646.010	565	2754	1	8011578944780

1"



**1647** PROLUNGA 1"  
 EXTENSION BAR 1"

				
1647.200	200	1310	1	8011578944803
1647.400	400	2250	1	8011578944827

1"



**1648** ADATTATORE 1" F - 3/4" M  
 ADAPTER 1" F - 3/4" M

					
1648.010	F 1"-M 3/4"	riduttore/reduction	404	1	8011578944841

1" 3/4"



**1649** CASSETTA 15 BUSSOLE E ACCESSORI 1"- metallo  
 METAL CASE 15 SOCKETS AND ACCES. 1"- metal

Contenuto-content:

1642.360	1642.750
1642.410	1642.800
1642.460	1645.010
1642.500	1646.010
1642.550	1647.200
1642.600	1647.400
1642.650	1648.010
1642.700	

1"

				
1649.010	660 x 205 x 100	31816	1	8011578944865



**1650** CHIAVE A BUSSOLA 1/2" MACCHINA IMPACT  
 SOCKET 1/2" - IMPACT

Icona	Modello	Ø	L	l	h	W	W	W	Barcode
	1650.080	8	38	16	24	60	6	6	8011578949808
	1650.100	10	38	16	24	60	6	6	8011578942120
	1650.110	11	38	17	24	64	6	6	8011578942144
	1650.120	12	38	19	24	64	6	6	8011578942168
	1650.130	13	38	20	24	66	6	6	8011578942182
	1650.140	14	38	22	24	68	6	6	8011578942205
	1650.150	15	38	24	24	76	6	6	8011578942229
	1650.160	16	38	24	24	74	6	6	8011578942243
	1650.170	17	40	26	26	96	6	6	8011578942267
	1650.180	18	40	28	28	117	6	6	8011578942281
	1650.190	19	40	28	28	104	6	6	8011578942304
	1650.210	21	40	28	30	110	6	6	8011578942328
	1650.220	22	40	28	32	123	6	6	8011578942342
	1650.240	24	42	28	34	134	6	6	8011578942366
	1650.270	27	45	30	38	188	6	6	8011578942380
	1650.300	30	46	30	42	205	6	6	8011578942403
	1650.320	32	50	30	44	218	6	6	8011578942427

1/2"



**1652** CHIAVE A BUSSOLA 1/2" MACCHINA IMPACT LUNGHE  
 SOCKET 1/2" - DEEP IMPACT

Icona	Modello	Ø	L	l	h	W	W	W	Barcode
	1652.100	10	78	16	24	124	2	2	8011578942441
	1652.130	13	78	21	25	160	2	2	8011578942465
	1652.140	14	78	22	24	154	2	2	8011578942489
	1652.150	15	78	26	30	194	2	2	8011578948788
	1652.170	17	78	22	24	194	2	2	8011578942502
	1652.190	19	78	28	28	222	2	2	8011578942526
	1652.210	21	78	28	32	265	2	2	8011578970024
	1652.220	22	78	28	32	265	2	2	8011578942540
	1652.240	24	78	28	34	290	2	2	8011578942564
	1652.270	27	78	30	38	352	2	2	8011578942588

1/2"



**1652Z** SERIE 8 BUSSOLE IMPACT LUNGHE 1/2" - binario  
 SET 8 SOCKETS - DEEP IMPACT 1/2" - holding bar

Contenuto-content:  
 1652.100 1652.170 1652.240  
 1652.130 1652.190 1652.270  
 1652.140 1652.220

1/2"

Icona	Modello	W	Barcode
	1652.908	1785	8011578945626



**1653** PROLUNGA 1/2" MACCHINA IMPACT  
 EXTENSION 1/2" - IMPACT

Icona	Modello	L	W	W	Barcode
	1653.012	125	232	2	8011578942823

1/2"



**1654** SNODO 1/2" MACCHINA IMPACT  
 UNIVERSAL JOIN 1/2" - IMPACT

Icona	Modello	L	W	W	Barcode
	1654.010	65	164	2	8011578942847

1/2"





**1655**

**SERIE 3 CHIAVI A BUSSOLA 1/2" LUNGHE MACCHINA**  
**SET 3 SOCKET 1/2" - DEEP IMPACT**



**1/2"**

 **1655.010**  mm 17-19-21

  **840 1**  80115781100004

**1658**

**SPINA**  
**PIN**





 **1658.010**  20  
**1658.020** 25

  **2,5 1**  80115781100004  
**3 1** 8011578948825

**1659**

**ANELLO**  
**RING**



 **1659.010**  20  
**1659.020** 26



  **2 1**  80115781100004  
**2 1** 8011578948863



**1664**

**CHIAVE A BUSSOLA 3/4" - MACCHINA IMPACT**  
**SOCKET 3/4" - IMPACT**

**3/4"**



    
**1664.170 17 50**  
**1664.190 19 50**  
**1664.210 21 50**  
**1664.220 22 50**  
**1664.230 23 50**  
**1664.240 24 50**  
**1664.260 26 50**  
**1664.270 27 50**  
**1664.300 30 53**  
**1664.320 32 53**  
**1664.330 33 55**  
**1664.360 36 55**  
**1664.380 38 58**  
**1664.410 41 58**  
**1664.460 46 62**

   80115781100004  
**322 2** 8011578965341  
**332 2** 8011578965365  
**345 2** 8011578965389  
**355 2** 8011578965402  
**358 2** 8011578965426  
**355 2** 8011578965440  
**375 2** 8011578965464  
**350 2** 8011578965488  
**408 2** 8011578965501  
**434 2** 8011578965525  
**464 2** 8011578965549  
**490 2** 8011578965563  
**525 2** 8011578965587  
**580 2** 8011578965600  
**738 2** 8011578965624

**new**

**new**

**new**

**new**

**new**

**new**

**new**

**new**

**new**

**new**

**new**

**new**

**new**

**new**



**1665** CHIAVE A BUSSOLA 3/4" - MACCHINA IMPACT LUNGHE  
 SOCKET 3/4" - DEEP IMPACT

3/4"



Model	Length (mm)	Weight (g)	Material	Quantity	Barcode	Status
1665.170	17	90	510	2	8011578962548	new
1665.190	19	90	518	2	8011578962562	new
1665.220	22	90	566	2	8011578962586	new
1665.240	24	90	586	2	8011578962609	new
1665.270	27	90	648	2	8011578962623	new
1665.300	30	90	698	2	8011578962647	new
1665.320	32	90	768	2	8011578962661	new
1665.330	33	90	736	2	8011578962685	new
1665.360	36	90	746	2	8011578962708	new
1665.410	41	90	920	2	8011578962722	new
1665.460	46	90	998	2	8011578962746	new

**1666** PROLUNGA 3/4" - MACCHINA IMPACT  
 EXTENSION 3/4" - IMPACT

3/4"



Model	Length (mm)	Weight (g)	Material	Quantity	Barcode
1666.010	100	586	2	8011578962760	

**1667** SNODO 3/4" - MACCHINA IMPACT  
 UNIVERSAL JOIN 3/4" - IMPACT

3/4"



Model	Length (mm)	Weight (g)	Material	Quantity	Barcode
1667.010	90	492	2	8011578962784	

**1668** RACCORDO DA 3/4" F - 1/2" M  
 ADAPTER FROM 3/4" F - 1/2" M

3/4" 1/2"



Model	Length (mm)	Weight (g)	Material	Quantity	Barcode
1668.010	58	324	2	8011578962807	

**1669** SPINA 3/4"  
 PIN 3/4"



Model	Weight (g)	Material	Quantity	Barcode
1669.010	2,5	1	8011578962821	

**1669** ANELLO 3/4"  
 RING 3/4"









Model	Weight (g)	Material	Quantity	Barcode
1669.050	2	1	8011578962845	

## 1670 CHIAVE A BUSSOLA 1" - MACCHINA IMPACT SOCKET 1" - IMPACT

1"



							
1670.360	36	63	692	1	8011578962869	<b>new</b>	
1670.410	41	66	844	1	8011578962883	<b>new</b>	
1670.460	46	70	1026	1	8011578962906	<b>new</b>	
1670.500	50	70	1124	1	8011578962920	<b>new</b>	
1670.550	55	83	1366	1	8011578962944	<b>new</b>	
1670.600	60	86	1690	1	8011578962968	<b>new</b>	
1670.650	65	85	1934	1	8011578962982	<b>new</b>	

## 1671 PROLUNGA 1" - MACCHINA IMPACT EXTENSION 1" - IMPACT

1"



						
1671.010	175	1414	1	8011578963002		

## 1673 RACCORDO DA 1" F - 3/4" M ADAPTER FROM 1" F - 3/4" M

1" 3/4"



						
1673.010	75	658	1	8011578963026		

## 1674 SPINA 1" PIN 1"



					
1674.010	2,5	1	8011578963088		

## 1674 ANELLO 1" RING 1"



					
1674.050	2	1	8011578963101		





**1700** CHIAVE DINAMOMETRICA ATTACCO 1/2"  
 TORQUE WRENCH 1/2"



1/2"



	Nm	←L→			
1700.110	20 - 110	370	1100	1	8011578948887
1700.210	42 - 210	450	1700	1	8011578948900
1700.350	70 - 350	630	2800	1	8011578948924

**1702** CHIAVE DINAMOMETRICA REVERSIBILE SGANCIO RAPIDO LETTURA A FINESTRA - PROFESSIONALE  
 TORQUE WRENCH REVERSIBLE - QUICK RELEASE SCALE READING WINDOW - PROFESSIONAL

tolleranza / tolerance ± 3%



1/2"



1/2"



1/2"





3/8"



1/4"



	Nm	←L→			
1702.025	5-25	1/4"	285	394	1 8011578965648
1702.050	10-50	3/8"	370	948	1 8011578965662
1702.100	10-100	1/2"	405	1020	1 8011578960247
1702.200	20-200	1/2"	500	1200	1 8011578960261
1702.300	60-300	1/2"	595	1330	1 8011578960308

new  
 new  
 new

**1750** BUSTA AVVOLGIBILE 12 UTENSILI  
 ROLLER BAG WITH 12 TOOLS



Contenuto-content:

0115.307	3x75	0377.020	gr. 200	1020.101	10x11
0115.612	6x125	0495.024	240	1020.123	12x13
0116.006	PH 0x60	1020.067	6x7	1020.145	14x15
0116.210	PH 2x100	1020.089	8x9	1020.167	16x17

	Pz.		
<b>1750.010</b>	<b>12</b>	1280	8011578750008

**1754** BUSTA AVVOLGIBILE 12 UTENSILI  
 ROLLER BAG WITH 12 TOOLS



Contenuto-content:

0115.612	6x125	0456.016	160	1020.101	10x11
0116.210	PH 2x100	0495.024	240	1020.123	12x13
0380.020	gr. 200	1020.067	6x7	1020.145	14x15
0425.018	180	1020.089	8x9	1020.167	16x17

	Pz.		
<b>1754.010</b>	<b>12</b>	1800	8011578754013

**1756** TASCA 4 UTENSILI  
 ENVELOPE 4 TOOLS



Contenuto-content:

0132.415  
 0135.108  
 0689.010  
 0440.918

	Pz.		
<b>1756.010</b>	<b>4</b>	<b>new</b> 423	8011578969608

**1756** TASCA 4 UTENSILI  
 ENVELOPE 4 TOOLS



Contenuto-content:

0090.410  
 0092.110  
 0683.010  
 0710.018

	Pz.		
<b>1756.020</b>	<b>4</b>	<b>new</b> 499	8011578969622

**1756** TASCA UTENSILI  
 ENVELOPE TOOLS



			
<b>1756.110</b>	vuota - empty	<b>new</b> 46	8011578969646

**1762** CASSETTA PORTAUTENSILI 39 UTENSILI - plastica  
 TOOL BOX 39 TOOLS - plastic

con interno asportabile  
 e portaminuterie  
 with removable interior and  
 tray for small parts

Contenuto - content:

0050.307 0490.024 1030.130  
 0050.410 0347.090 1030.140  
 0050.612 0377.030 1030.170  
 0052.108 0689.010 1030.190  
 0052.210 1030.080 1844.010  
 0236.010 1030.090 1820.030  
 0440.918 1030.100  
 0412.916 1030.110



	— L —		
<b>1762.010</b>	470 x 260 x 220	3900	8011578931766

**1762** CASSETTA PORTAUTENSILI - plastica  
 TOOL BOX - plastic

con interno asportabile  
 e portaminuterie  
 with removable interior and  
 tray for small parts

470 x 260 x 220



			
<b>1762.210</b>	vuota - empty	2100	8011578931773

**1764** CASSETTA METALLO 33 UTENSILI 5 SCOMPARTI  
 METAL TOOL BOX WITH 33 TOOLS 5 TRAY



Contenuto - content:

0050.307	0052.210	0490.024	1020.067	1020.145
0050.410	0347.090	0377.030	1020.089	1020.167
0050.612	0412.916	0620.010	1020.101	1020.189
0052.108	0440.918	0683.010	1020.123	1020.202

     
**1764.010** 545 x 215 x 225 8750 8011578764005

**1764** CASSETTA METALLO 5 SCOMPARTI - LUNGA  
 METAL TOOL BOX WITH 5 TRAY - LONG



545 x 215 x 225

     
**1764.015** vuota - empty 5700 8011578934361

**1765** BORSA 28 UTENSILI PER INSTALLATORE  
 BAG WITH 28 TOOLS FOR INSTALLER



Contenuto - content:

1844.010	0050.612	0683.010	1020.101	0440.918	1765.110
0232.306	0052.108	1820.030	1020.123	0412.916	
0050.307	0052.210	1020.067	1020.167	0495.024	
0050.410	0347.090	1020.089	0463.916	0377.020	

     
**1765.010** 430 x 290 x 190 6070 8011578931780

**1765** BORSA PER INSTALLATORE  
 BAG FOR INSTALLER



430 x 290 x 190

    
**1765.110** vuota - empty 3400 8011578949822

**1766** VALIGIA 41 UTENSILI PER ASSISTENZA - 2 pann.  
 SUITCASE WITH 41 TOOLS - 2 panels



Contenuto - content:

0050.307	1070.015	0440.918	0540.210	0527.010	0162.310
0050.410	1844.010	0377.020	0541.210	0524.010	0163.005
0050.612	0683.010	0558.010	0520.010	0526.010	0163.006
0052.108	0347.090	0532.110	0522.010	0232.306	1766.110
0052.112	0412.916	0532.210	0528.010	0162.105	
0052.210	0463.916	0540.110	0525.010	0162.207	

     
**1766.010** 490 x 370 x 190 8000 8011578931872

**1766** VALIGIA ABS ANTIURTO - 2 pann.  
 ABS SUITCASE - 2 panels



490 x 370 x 190

    
**1766.110** vuota - empty 5500 8011578931841

**1767** VALIGIA 38 UTENSILI PER ASSISTENZA - 2 pann.  
 SUITCASE WITH 38 TOOLS - 2 panels



Contenuto - content:

- 0050.307 1030.190
- 0050.410 1030.220
- 0050.512 1820.030
- 0050.612 1844.010
- 0052.006 1767.110
- 0052.108
- 0052.210
- 0232.306
- 0347.090
- 0377.030
- 0412.916
- 0417.022
- 0440.918
- 0463.916
- 0490.024
- 0689.010
- 1030.060
- 1030.070
- 1030.080
- 1030.090
- 1030.100
- 1030.110
- 1030.120
- 1030.130
- 1030.150
- 1030.170

     
**1767.010** 490 x 390 x 190 12100 8011578969189

**1770** BORSA 14 UTENSILI ISOLATI 1000 volt VDE  
 BAG 14 INSULATED TOOLS 1000 volt VDE



Contenuto-content:

- 0090.310 0683.010
- 0090.410 0710.018
- 0090.512 0712.020
- 0090.615 0716.016
- 0092.007 0722.010
- 0092.110 1765.110
- 0092.210
- 0232.306
- 0377.020

     
**1770.010** 430 x 290 x 190 5080 8011578770006

**1774** VALIGIA 14 UTENSILI ISOLATI 1000 volt VDE  
 SUITCASE 14 INSULATED TOOLS 1000 volt VDE



Contenuto-content:

- 0090.310 0683.010
- 0090.410 0710.018
- 0090.512 0712.020
- 0090.615 0716.016
- 0092.007 0722.010
- 0092.110 1766.110
- 0092.210
- 0232.306
- 0377.020

     
**1774.010** 490 x 370 x 190 7200 8011578774004

**1767** VALIGIA ALLUMINIO ANTIURTO - 2 pann.  
 ALUMINIUM SUITCASE - 2 panels



490 x 390 x 190

   
**1767.110** vuota - empty 5600 8011578965846



**1778**

**BORSA 28 UTENSILI PER IDRAULICI**  
**BAG 28 TOOLS FOR HYDRAULIC**



Contenuto - content:

- 0050.307
- 0050.410
- 0050.612
- 0052.108
- 0052.210
- 0347.090
- 0412.916
- 0440.918
- 0490.024
- 0502.032
- 0792.042
- 0774.032
- 1020.067
- 1020.089
- 1020.101
- 1020.123
- 1020.145
- 1020.167
- 1020.189
- 1020.202



**1778.010** 460 x 180 x 180

5650

8011578778002

**1780**

**VALIGIA 27 UTENSILI - STAGNA IP67**  
**SUITCASE WITH 27 TOOLS - IP67**



Contenuto - content:

- 0347.090
- 1030.080
- 1030.090
- 1030.100
- 1030.110
- 1030.130
- 1030.140
- 1030.170
- 1030.190
- 0050.307
- 0050.410
- 0050.612
- 0052.108
- 0052.210
- 1070.015
- 0683.010
- 0490.024
- 0440.918
- 0463.916
- 1780.110



**1780.010** 470 x 360 x 175

**new** 6500

8011578969202

**1778**

**BORSA PER IDRAULICI**  
**BAG FOR HYDRAULIC**



460 x 180 x 180



**1778.110** vuota - empty

1800

8011578778026

**1780**

**VALIGIA UTENSILI - STAGNA IP67**  
**SUITCASE TOOLS - IP67**



470 x 360 x 175



**1780.110** vuota - empty

**new** 4100

8011578969226



## 1803.210

### CARRELLO 3 RIPIANI - vuoto TROLLEY 3 TRAYS - empty



- Ruote 100 mm - 2 ruote girevoli con freno  
Wheels 100 mm - 2 wheels with brake
- Carico statico totale 200 kg  
Total static load 200 kg
- Fornito smontato - dimensioni scatola 760 x 460 x 260  
Supplied unassembled - box dimensions 760 x 460 x 260

     
**1803.210** 710 x 410 x 910 17800 8011578963361 **new**

## 1805.210

### CASSETTIERA PORTATILE 6 CASSETTI - vuota PORTABLE CHEST OF DRAWER 6 DRAWERS - empty



- 1 cassetto/drawer h 74
- 2 cassetti/drawers h 51
- 3 cassetti piccoli/small drawers h 51
- 1 vano superiore apribile/upper openable case h 74
- Guide telescopiche a sfera/Ball bearing sliders
- Serratura centralizzata/Lock
- Maniglie laterali per trasporto/Side handles for handling

     
**1805.210** 660 x 320 x 380 24500 8011578943707

## 1805.056

### CASSETTIERA CON 56 UTENSILI - 4 moduli CHEST OF DRAWER WITH 56 TOOLS - 4 modules

Contenuto-content:

1805.210  
1815.010  
1815.040  
1815.100  
1815.140



1815.010



1815.040



1815.100



1815.140

     
**1805.056** 660 x 320 x 380 30500 8011578949624



**1810.210** CARRELLO 7 CASSETTI - vuoto  
 TROLLEY 7 DRAWERS - empty

**CARICO STATICO**  
 TOTAL STATIC LOAD  
 KG. 700



- 5 cassetti/drawers h 65 x 385 x 570
- 2 cassetti/drawers h 125 x 385 x 570
- Carico statico totale 700 kg  
 Total static load 700 kg
- Guide telescopiche a sfera/Ball bearing sliders
- 2 ruote fisse - 2 ruote girevoli con freno  
 2 wheels - 2 wheel with brake
- Serratura centralizzata/Lock
- Piano di lavoro in gomma/Rubber top mat

	— L —		
<b>1810.210</b>	700 x 470 x 990	60000	8011578947866
<b>1810.201</b>	serratura/lock	52	8011578996963

# 1810.064

## CARRELLO CON 64 UTENSILI - 6 moduli TROLLEY WITH 64 TOOLS - 6 modules



<b>1815.010:</b>					
0050.307	3 x 75	0050.815	8 x 150	0055.603	6 x 38
0050.410	4 x 100	0052.006	PH 0 x 60	0056.103	PH 1 x 38
0050.510	5,5 x 100	0052.108	PH 1 x 80		
0050.612	6,5 x 125	0052.210	PH 2 x 100		
<b>1815.040:</b>					
1030.060	mm 6	1030.120	mm 12	1030.180	mm 18
1030.070	mm 7	1030.130	mm 13	1030.190	mm 19
1030.080	mm 8	1030.140	mm 14	1030.200	mm 20
1030.090	mm 9	1030.150	mm 15	1030.220	mm 22
1030.100	mm 10	1030.160	mm 16	1030.240	mm 24
1030.110	mm 11	1030.170	mm 17		
<b>1815.100:</b>					
1500.080	mm 8	1500.160	mm 16	1500.270	mm 27
1500.090	mm 9	1500.170	mm 17	1500.300	mm 30
1500.100	mm 10	1500.180	mm 18	1500.320	mm 32
1500.110	mm 11	1500.190	mm 19	1505.010	
1500.120	mm 12	1500.200	mm 20	1508.125	mm 125
1500.130	mm 13	1500.210	mm 21	1508.250	mm 250
1500.140	mm 14	1500.220	mm 22	1510.010	
1500.150	mm 15	1500.240	mm 24	1512.010	
<b>1815.120:</b>					
0377.030	gr 300	0616.015	mm 150		
0370.035	mm 35	0612.016	mm 160		
<b>1815.140:</b>					
0440.918	mm 180	0463.916	mm 160	0490.024	mm 240
0412.916	mm 160	0474.025	mm 250		
<b>1815.150:</b>					
0505.018	mm 180	0510.018	mm 180		
0506.017	mm 170	0511.017	mm 170		

Contenuto-content:

- 1810.210
- 1815.010 1815.120
- 1815.040 1815.140
- 1815.100 1815.150

 **1810.064** 700 x 470 x 990

 68900  8011578810023

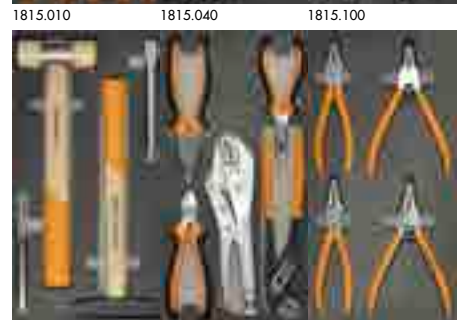
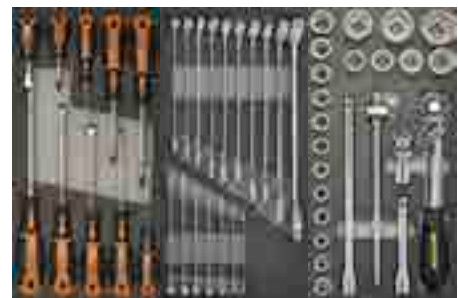

1815.010 1815.040 1815.100

1815.120 1815.140 1815.150

# 1814.064

## ASSORTIMENTO 64 UTENSILI - 6 moduli SET 64 TOOLS - 6 modules

 **1814.064**

 9900  8011578949006

Contenuto-content:

- 1815.010 1815.120
- 1815.040 1815.140
- 1815.100 1815.150

# 1810.067

## CARRELLO CON 67 UTENSILI - 6 moduli TROLLEY WITH 67 TOOLS - 6 modules



<b>1815.010:</b>					
0050.307	3 x 75	0050.815	8 x 150	0055.603	6 x 38
0050.410	4 x 100	0052.006	PH 0 x 60	0056.103	PH 1 x 38
0050.510	5,5 x 100	0052.108	PH 1 x 80		
0050.612	6,5 x 125	0052.210	PH 2 x 100		
<b>1815.040:</b>					
1030.060	mm 6	1030.120	mm 12	1030.180	mm 18
1030.070	mm 7	1030.130	mm 13	1030.190	mm 19
1030.080	mm 8	1030.140	mm 14	1030.200	mm 20
1030.090	mm 9	1030.150	mm 15	1030.220	mm 22
1030.100	mm 10	1030.160	mm 16	1030.240	mm 24
1030.110	mm 11	1030.170	mm 17		
<b>1815.100:</b>					
1500.080	mm 8	1500.160	mm 16	1500.270	mm 27
1500.090	mm 9	1500.170	mm 17	1500.300	mm 30
1500.100	mm 10	1500.180	mm 18	1500.320	mm 32
1500.110	mm 11	1500.190	mm 19	1505.010	
1500.120	mm 12	1500.200	mm 20	1508.125	mm 125
1500.130	mm 13	1500.210	mm 21	1508.250	mm 250
1500.140	mm 14	1500.220	mm 22	1510.010	
1500.150	mm 15	1500.240	mm 24	1512.010	
<b>1815.120:</b>					
0377.030	gr 300	0616.015	mm 150		
0370.035	mm 35	0612.016	mm 160		
<b>1815.140:</b>					
0440.918	mm 180	0463.916	mm 160	0490.024	mm 240
0412.916	mm 160	0474.025	mm 250		
<b>1815.180:</b>					
0344.020	mm 2	0344.040	mm 4	0344.080	mm 8
0344.025	mm 2,5	0344.050	mm 5		
0344.030	mm 3	0344.060	mm 6		

Contenuto-content:

- 1810.210
- 1815.010 1815.120
- 1815.040 1815.140
- 1815.100 1815.180

 **1810.067** 700 x 470 x 990

 68700  8011578810047



1815.010 1815.040 1815.100

1815.120 1815.140 1815.180

# 1814.067

## ASSORTIMENTO 67 UTENSILI - 6 moduli SET 67 TOOLS - 6 modules

 **1814.067**

 9700  8011578949020

Contenuto-content:

- 1815.010 1815.120
- 1815.040 1815.140
- 1815.100 1815.180



**1810.128** CARRELLO CON 128 UTENSILI - 9 moduli  
 TROLLEY WITH 128 TOOLS - 9 modules

<b>1815.010:</b>					
0050.307	3 x 75	0050.815	8 x 150	0055.603	6 x 38
0050.410	4 x 100	0052.006	PH 0 x 60	0056.103	PH 1 x 38
0050.510	5,5 x 100	0052.108	PH 1 x 80		
0050.612	6,5 x 125	0052.210	PH 2 x 100		
<b>1815.040:</b>					
1030.060	mm 6	1030.120	mm 12	1030.180	mm 18
1030.070	mm 7	1030.130	mm 13	1030.190	mm 19
1030.080	mm 8	1030.140	mm 14	1030.200	mm 20
1030.090	mm 9	1030.150	mm 15	1030.220	mm 22
1030.100	mm 10	1030.160	mm 16	1030.240	mm 24
1030.110	mm 11	1030.170	mm 17		
<b>1815.090:</b>					
1400.040	mm 4	1400.120	mm 12	1438.200	TX 20
1400.045	mm 4,5	1400.130	mm 13	1438.250	TX 25
1400.050	mm 5	1436.030	mm 3	1438.270	TX 27
1400.055	mm 5,5	1436.040	mm 4	1438.300	TX 30
1400.060	mm 6	1436.050	mm 5	1438.400	TX 40
1400.070	mm 7	1436.060	mm 6	1405.010	
1400.080	mm 8	1436.080	mm 8	1408.075	mm 75
1400.090	mm 9	1438.080	TX 8	1408.150	mm 150
1400.100	mm 10	1438.100	TX 10	1410.010	
1400.110	mm 11	1438.150	TX15	1412.010	
0351.090	mm 1,5-2-2,5-3-4-5-6-8-10				
0366.090	TX 10-15-20-25-27-30-40-45-50				
<b>1815.100:</b>					
1500.080	mm 8	1500.160	mm 16	1500.270	mm 27
1500.090	mm 9	1500.170	mm 17	1500.300	mm 30
1500.100	mm 10	1500.180	mm 18	1500.320	mm 32
1500.110	mm 11	1500.190	mm 19	1505.010	
1500.120	mm 12	1500.200	mm 20	1508.125	mm 125
1500.130	mm 13	1500.210	mm 21	1508.250	mm 250
1500.140	mm 14	1500.220	mm 22	1510.010	
1500.150	mm 15	1500.240	mm 24	1512.010	
<b>1815.120:</b>					
0377.030	gr 300	0616.015	mm 150		
0370.035	mm 35	0612.016	mm 160		
<b>1815.140:</b>					
0440.918	mm 180	0463.916	mm 160	0490.024	mm 240
0412.916	mm 160	0474.025	mm 250		
<b>1815.150:</b>					
0505.018	mm 180	0510.018	mm 180		
0506.017	mm 170	0511.017	mm 170		
<b>1815.180:</b>					
0344.020	mm 2	0344.040	mm 4	0344.080	mm 8
0344.025	mm 2,5	0344.050	mm 5		
0344.030	mm 3	0344.060	mm 6		
<b>1815.300:</b>					
0560.025	mm 250	1070.020	mm 200		
0683.010		0620.010			



1815.010 1815.040 1815.090



1815.100 1815.120 1815.140



1815.150 1815.180 1815.300

Contenuto-content:

- 1810.210
- 1815.010
- 1815.040
- 1815.090
- 1815.100
- 1815.120
- 1815.140
- 1815.150
- 1815.180
- 1815.300

 **1810.128** 700 x 470 x 990

→ L ←

 72400

 801157810061

**1814.128** ASSORTIMENTO 128 UTENSILI - 9 moduli  
 SET 128 TOOLS - 9 modules

- Contenuto-content:
- 1815.010 1815.120 1815.300
  - 1815.040 1815.140
  - 1815.090 1815.150
  - 1815.100 1815.180

 **1814.128**

 13400

 8011578949044

# 1810.159

## CARRELLO CON 159 UTENSILI - 9 moduli TROLLEY WITH 159 TOOLS - 9 modules



<b>1815.010:</b>					
0050.307	3 x 75	0050.815	8 x 150	0055.603	6 x 38
0050.410	4 x 100	0052.006	PH 0 x 60	0056.103	PH 1 x 38
0050.510	5,5 x 100	0052.108	PH 1 x 80		
0050.612	6,5 x 125	0052.210	PH 2 x 100		
<b>1815.020:</b>					
0075.060	TX 6	0075.100	TX 10	0075.027	TX 27
0075.070	TX 7	0075.015	TX 15	0075.030	TX 30
0075.080	TX 8	0075.020	TX 20		
0075.090	TX 9	0075.025	TX 25		
<b>1815.040:</b>					
1030.060	mm 6	1030.120	mm 12	1030.180	mm 18
1030.070	mm 7	1030.130	mm 13	1030.190	mm 19
1030.080	mm 8	1030.140	mm 14	1030.200	mm 20
1030.090	mm 9	1030.150	mm 15	1030.220	mm 22
1030.100	mm 10	1030.160	mm 16	1030.240	mm 24
1030.110	mm 11	1030.170	mm 17		
<b>1815.050:</b>					
1030.270	mm 27	1030.300	mm 30	1030.320	mm 32
<b>1815.090:</b>					
1400.040	mm 4	1400.120	mm 12	1438.200	TX 20
1400.045	mm 4,5	1400.130	mm 13	1438.250	TX 25
1400.050	mm 5	1436.030	mm 3	1438.270	TX 27
1400.055	mm 5,5	1436.040	mm 4	1438.300	TX 30
1400.060	mm 6	1436.050	mm 5	1438.400	TX 40
1400.070	mm 7	1436.060	mm 6	1405.010	
1400.080	mm 8	1436.080	mm 8	1408.075	mm 75
1400.090	mm 9	1438.080	TX 8	1408.150	mm 150
1400.100	mm 10	1438.100	TX 10	1410.010	
1400.110	mm 11	1438.150	TX15	1412.010	
0351.090	mm 1,5-2-2,5-3-4-5-6-8-10				
0366.090	TX 10-15-20-25-27-30-40-45-50				
<b>1815.100:</b>					
1500.080	mm 8	1500.160	mm 16	1500.270	mm 27
1500.090	mm 9	1500.170	mm 17	1500.300	mm 30
1500.100	mm 10	1500.180	mm 18	1500.320	mm 32
1500.110	mm 11	1500.190	mm 19	1505.010	
1500.120	mm 12	1500.200	mm 20	1508.125	mm 125
1500.130	mm 13	1500.210	mm 21	1508.250	mm 250
1500.140	mm 14	1500.220	mm 22	1510.010	
1500.150	mm 15	1500.240	mm 24	1512.010	
<b>1815.140:</b>					
0440.918	mm 180	0463.916	mm 160	0490.024	mm 240
0412.916	mm 160	0474.025	mm 250		
<b>1815.150:</b>					
0505.018	mm 180	0510.018	mm 180		
0506.017	mm 170	0511.017	mm 170		
<b>1815.180:</b>					
0344.020	mm 2	0344.040	mm 4	0344.080	mm 8
0344.025	mm 2,5	0344.050	mm 5		
0344.030	mm 3	0344.060	mm 6		
<b>0237.010:</b>					
0240.010		0251.300	PZ 3 x 25	0255.300	TX 30 x 25
0249.400	4 x 25	0255.060	TX 6 x 25	0263.015	1,5 x 25
0249.500	5 x 25	0255.070	TX 7 x 25	0263.020	2 x 25
0249.600	6 x 25	0255.080	TX 8 x 25	0263.030	3 x 25
0250.100	PH 1 x 25	0255.090	TX 9 x 25	0263.040	4 x 25
0250.200	PH 2 x 25	0255.100	TX 10 x 25	0263.050	5 x 25
0250.300	PH 3 x 25	0255.150	TX 15 x 25	0263.060	6 x 25
0251.100	PZ 1 x 25	0255.200	TX 20 x 25		
0251.200	PZ 2 x 25	0255.250	TX 25 x 25		

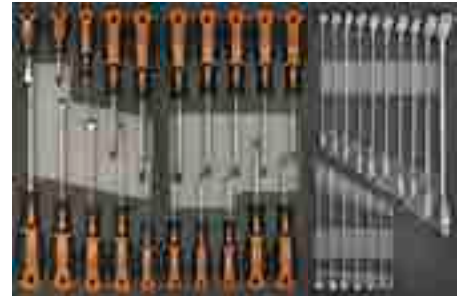

1815.010 1815.020 1815.040



1815.050 1815.090 1815.100



1815.120 1815.140 1815.150



0237.010



1150.080 - 1150.100 - 1150.130 - 1150.150 - 1150.170

Contenuto-content:

- 1810.210
- 1815.010
- 1815.020
- 1815.040
- 1815.050
- 1815.090
- 1815.100
- 1815.140
- 1815.150
- 1815.180
- 0237.010
- 1150.080
- 1150.100
- 1150.130
- 1150.150
- 1150.170

 **1810.159** 700 x 470 x 990

 **75485**  8011578970048

**new**

# 1814.159

## ASSORTIMENTO 159 UTENSILI - 9 moduli SET 159 TOOLS - 9 modules

 **1814.159**

 **13245**  8011578970086

**new**

Contenuto-content:

- 1815.010 1815.090 1815.180 1150.130
- 1815.020 1815.100 0237.010 1150.150
- 1815.040 1815.140 1150.080 1150.170
- 1815.050 1815.150 1150.100

# 1810.166

## CARRELLO CON 166 UTENSILI - 13 moduli TROLLEY WITH 166 TOOLS - 13 modules

<b>1815.010:</b>			
0050.307	3 x 75	0050.815	8 x 150
0050.410	4 x 100	0052.006	PH 0 x 60
0050.510	5,5 x 100	0052.108	PH 1 x 80
0050.612	6,5 x 125	0052.210	PH 2 x 100
<b>1815.020:</b>			
0075.060	TX 6	0075.100	TX 10
0075.070	TX 7	0075.015	TX 15
0075.080	TX 8	0075.020	TX 20
0075.090	TX 9	0075.025	TX 25
<b>1815.040:</b>			
1030.060	mm 6	1030.120	mm 12
1030.070	mm 7	1030.130	mm 13
1030.080	mm 8	1030.140	mm 14
1030.090	mm 9	1030.150	mm 15
1030.100	mm 10	1030.160	mm 16
1030.110	mm 11	1030.170	mm 17
<b>1815.070:</b>			
1020.067	mm 6x7	1020.123	mm 12x13
1020.089	mm 8x9	1020.145	mm 14x15
1020.101	mm 10x11	1020.167	mm 16x17
0347.090	mm 1,5-2-2,5-3-4-5-6-8-10		
<b>1815.090:</b>			
1400.040	mm 4	1400.120	mm 12
1400.045	mm 4,5	1400.130	mm 13
1400.050	mm 5	1436.030	mm 3
1400.055	mm 5,5	1436.040	mm 4
1400.060	mm 6	1436.050	mm 5
1400.070	mm 7	1436.060	mm 6
1400.080	mm 8	1436.080	mm 8
1400.090	mm 9	1438.080	TX 8
1400.100	mm 10	1438.100	TX 10
1400.110	mm 11	1438.150	TX15
0351.090	mm 1,5-2-2,5-3-4-5-6-8-10		
0366.090	TX 10-15-20-25-27-30-40-45-50		
<b>1815.100:</b>			
1500.080	mm 8	1500.160	mm 16
1500.090	mm 9	1500.170	mm 17
1500.100	mm 10	1500.180	mm 18
1500.110	mm 11	1500.190	mm 19
1500.120	mm 12	1500.200	mm 20
1500.130	mm 13	1500.210	mm 21
1500.140	mm 14	1500.220	mm 22
1500.150	mm 15	1500.240	mm 24
1500.270	mm 27		
1500.300	mm 30		
1500.320	mm 32		
1505.010			
			mm 125
			mm 250
1510.010			
1512.010			
0377.030	gr 300	0616.015	mm 150
0370.035	mm 35	0612.016	mm 160
<b>1815.140:</b>			
0440.918	mm 180	0463.916	mm 160
0412.916	mm 160	0474.025	mm 250
<b>1815.150:</b>			
0505.018	mm 180	0510.018	mm 180
0506.017	mm 170	0511.017	mm 170
<b>1815.180:</b>			
0344.020	mm 2	0344.040	mm 4
0344.025	mm 2,5	0344.050	mm 5
0344.030	mm 3	0344.060	mm 6
<b>1815.200:</b>			
0344.320	mm 2	0344.340	mm 4
0344.325	mm 2,5	0344.350	mm 5
0344.330	mm 3	0344.360	mm 6
<b>1815.300:</b>			
0560.025	mm 250	1070.020	mm 200
0683.010		0620.010	
<b>1815.380:</b>			
1150.080	mm 8	1150.130	mm 13
1150.100	mm 10	1150.170	mm 17



Contenuto-content:

- 1810.210
- 1815.010
- 1815.020
- 1815.040
- 1815.070
- 1815.090
- 1815.100
- 1815.120
- 1815.140
- 1815.150
- 1815.180
- 1815.200
- 1815.300
- 1815.380

 **1810.166** 700 x 470 x 990

 77100

  
 8011578810085

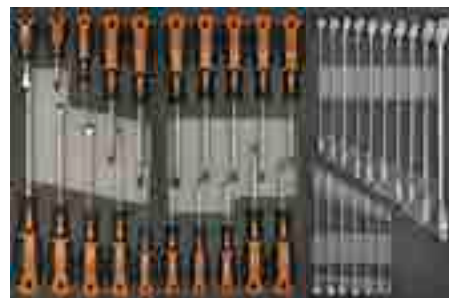

1815.010 1815.020 1815.040



1815.070 1815.090 1815.100



1815.120 1815.140 1815.150



1815.180 1815.200 1815.300

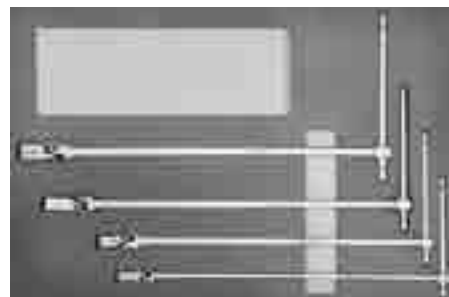

1815.380

# 1814.166

## ASSORTIMENTO 166 UTENSILI - 13 moduli SET 166 TOOLS - 13 modules

Contenuto-content:

- 1815.010 1815.090 1815.150 1815.380
- 1815.020 1815.100 1815.180
- 1815.040 1815.120 1815.200
- 1815.070 1815.140 1815.300

 **1814.166**

 18100

  
 8011578949068

# 1810.181

## CARRELLO CON 181 UTENSILI - 15 moduli TROLLEY WITH 181 TOOLS - 15 modules



Contenuto-content:

- 1810.210
- 1815.010
- 1815.020
- 1815.040
- 1815.050
- 1815.070
- 1815.090
- 1815.100
- 1815.120
- 1815.140
- 1815.150
- 1815.180
- 1815.200
- 1815.220
- 1815.260
- 1815.300

  **1810.181** 700 x 470 x 990

  **79500** 8011578810108

<b>1815.010:</b>					
0050.307	3 x 75	0050.815	8 x 150	0055.603	6 x 38
0050.410	4 x 100	0052.006	PH 0 x 60	0056.103	PH 1 x 38
0050.510	5,5 x 100	0052.108	PH 1 x 80		
0050.612	6,5 x 125	0052.210	PH 2 x 100		
<b>1815.020:</b>					
0075.060	TX 6	0075.100	TX 10	0075.027	TX 27
0075.070	TX 7	0075.015	TX 15	0075.030	TX 30
0075.080	TX 8	0075.020	TX 20		
0075.090	TX 9	0075.025	TX 25		
<b>1815.040:</b>					
1030.060	mm 6	1030.120	mm 12	1030.180	mm 18
1030.070	mm 7	1030.130	mm 13	1030.190	mm 19
1030.080	mm 8	1030.140	mm 14	1030.200	mm 20
1030.090	mm 9	1030.150	mm 15	1030.220	mm 22
1030.100	mm 10	1030.160	mm 16	1030.240	mm 24
1030.110	mm 11	1030.170	mm 17		
<b>1815.050:</b>					
1030.270	mm 27	1030.300	mm 30	1030.320	mm 32
<b>1815.070:</b>					
1020.067	mm 6x7	1020.123	mm 12x13	1020.189	mm 18x19
1020.089	mm 8x9	1020.145	mm 14x15	1020.202	mm 20x22
1020.101	mm 10x11	1020.167	mm 16x17		
0347.090	mm 1,5-2-2,5-3-4-5-6-8-10				
<b>1815.090:</b>					
1400.040	mm 4	1400.120	mm 12	1438.200	TX 20
1400.045	mm 4,5	1400.130	mm 13	1438.250	TX 25
1400.050	mm 5	1436.030	mm 3	1438.270	TX 27
1400.055	mm 5,5	1436.040	mm 4	1438.300	TX 30
1400.060	mm 6	1436.050	mm 5	1438.400	TX 40
1400.070	mm 7	1436.060	mm 6	1405.010	
1400.080	mm 8	1436.080	mm 8	1408.075	mm 75
1400.090	mm 9	1438.080	TX 8	1408.150	mm 150
1400.100	mm 10	1438.100	TX 10	1410.010	
1400.110	mm 11	1438.150	TX 15	1412.010	
0351.090	mm 1,5-2-2,5-3-4-5-6-8-10				
0366.090	TX 10-15-20-25-27-30-40-45-50				
<b>1815.100:</b>					
1500.080	mm 8	1500.160	mm 16	1500.270	mm 27
1500.090	mm 9	1500.170	mm 17	1500.300	mm 30
1500.100	mm 10	1500.180	mm 18	1500.320	mm 32
1500.110	mm 11	1500.190	mm 19	1505.010	
1500.120	mm 12	1500.200	mm 20	1508.125	mm 125
1500.130	mm 13	1500.210	mm 21	1508.250	mm 250
1500.140	mm 14	1500.220	mm 22	1510.010	
1500.150	mm 15	1500.240	mm 24	1512.010	
<b>1815.120:</b>					
0377.030	gr 300	0616.015	mm 150		
0370.035	mm 35	0612.016	mm 160		
<b>1815.140:</b>					
0440.918	mm 180	0463.916	mm 160	0490.024	mm 240
0412.916	mm 160	0474.025	mm 250		
<b>1815.150:</b>					
0505.018	mm 180	0510.018	mm 180		
0506.017	mm 170	0511.017	mm 170		
<b>1815.180:</b>					
0344.020	mm 2	0344.040	mm 4	0344.080	mm 8
0344.025	mm 2,5	0344.050	mm 5		
0344.030	mm 3	0344.060	mm 6		
<b>1815.200:</b>					
0344.320	mm 2	0344.340	mm 4	0344.380	mm 8
0344.325	mm 2,5	0344.350	mm 5		
0344.330	mm 3	0344.360	mm 6		
<b>1815.220:</b>					
1098.080	mm 8	1098.110	mm 11	1098.170	mm 17
1098.090	mm 9	1098.130	mm 13	1098.190	mm 19
1098.100	mm 10	1098.140	mm 14		
<b>1815.260:</b>					
1055.080	mm 8	1055.120	mm 12	1055.170	mm 17
1055.100	mm 10	1055.130	mm 13	1055.190	mm 19
1055.110	mm 11	1055.140	mm 14		
<b>1815.300:</b>					
0560.025	mm 250	1070.020	mm 200		
0683.010		0620.010			

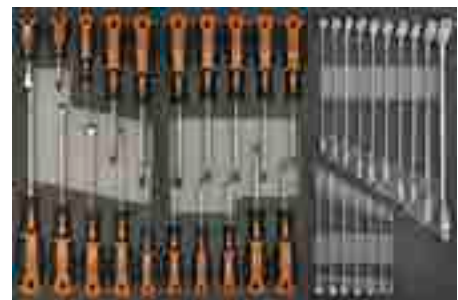

1815.010 1815.020 1815.040



1815.050 1815.070 1815.090



1815.100 1815.120 1815.140



1815.150 1815.180 1815.200



1815.220 1815.260 1815.300

# 1814.181

## ASSORTIMENTO 181 UTENSILI - 15 moduli SET 181 TOOLS - 15 modules

 **1814.181**

  **20500** 8011578949082

Contenuto-content:

- 1815.010 1815.070 1815.140 1815.220
- 1815.020 1815.090 1815.150 1815.260
- 1815.040 1815.100 1815.180 1815.300
- 1815.050 1815.120 1815.200

**1810.185** CARRELLO CON 185 UTENSILI - 16 moduli  
 TROLLEY WITH 185 TOOLS - 16 modules



Contenuto-content:

- 1810.210
- 1815.010
- 1815.020
- 1815.040
- 1815.050
- 1815.070
- 1815.090
- 1815.100
- 1815.120
- 1815.140
- 1815.150
- 1815.180
- 1815.200
- 1815.220
- 1815.260
- 1815.300
- 1815.380

<b>1815.010:</b>					
0050.307	3 x 75	0050.815	8 x 150	0055.603	6 x 38
0050.410	4 x 100	0052.006	PH 0 x 60	0056.103	PH 1 x 38
0050.510	5,5 x 100	0052.108	PH 1 x 80		
0050.612	6,5 x 125	0052.210	PH 2 x 100		
<b>1815.020:</b>					
0075.060	TX 6	0075.100	TX 10	0075.027	TX 27
0075.070	TX 7	0075.015	TX 15	0075.030	TX 30
0075.080	TX 8	0075.020	TX 20		
0075.090	TX 9	0075.025	TX 25		
<b>1815.040:</b>					
1030.060	mm 6	1030.120	mm 12	1030.180	mm 18
1030.070	mm 7	1030.130	mm 13	1030.190	mm 19
1030.080	mm 8	1030.140	mm 14	1030.200	mm 20
1030.090	mm 9	1030.150	mm 15	1030.220	mm 22
1030.100	mm 10	1030.160	mm 16	1030.240	mm 24
1030.110	mm 11	1030.170	mm 17		
<b>1815.050:</b>					
1030.270	mm 27	1030.300	mm 30	1030.320	mm 32
<b>1815.070:</b>					
1020.067	mm 6x7	1020.123	mm 12x13	1020.189	mm 18x19
1020.089	mm 8x9	1020.145	mm 14x15	1020.202	mm 20x22
1020.101	mm 10x11	1020.167	mm 16x17		
0347.090	mm 1,5-2-2,5-3-4-5-6-8-10				
<b>1815.090:</b>					
1400.040	mm 4	1400.120	mm 12	1438.200	TX 20
1400.045	mm 4,5	1400.130	mm 13	1438.250	TX 25
1400.050	mm 5	1436.030	mm 3	1438.270	TX 27
1400.055	mm 5,5	1436.040	mm 4	1438.300	TX 30
1400.060	mm 6	1436.050	mm 5	1438.400	TX 40
1400.070	mm 7	1436.060	mm 6	1405.010	
1400.080	mm 8	1436.080	mm 8	1408.075	mm 75
1400.090	mm 9	1438.080	TX 8	1408.150	mm 150
1400.100	mm 10	1438.100	TX 10	1410.010	
1400.110	mm 11	1438.150	TX15	1412.010	
0351.090	mm 1,5-2-2,5-3-4-5-6-8-10				
0366.090	TX 10-15-20-25-27-30-40-45-50				
<b>1815.100:</b>					
1500.080	mm 8	1500.160	mm 16	1500.270	mm 27
1500.090	mm 9	1500.170	mm 17	1500.300	mm 30
1500.100	mm 10	1500.180	mm 18	1500.320	mm 32
1500.110	mm 11	1500.190	mm 19	1505.010	
1500.120	mm 12	1500.200	mm 20	1508.125	mm 125
1500.130	mm 13	1500.210	mm 21	1508.250	mm 250
1500.140	mm 14	1500.220	mm 22	1510.010	
1500.150	mm 15	1500.240	mm 24	1512.010	
<b>1815.120:</b>					
0377.030	gr 300	0616.015	mm 150		
0370.035	mm 35	0612.016	mm 160		
<b>1815.140:</b>					
0440.918	mm 180	0463.916	mm 160	0490.024	mm 240
0412.916	mm 160	0474.025	mm 250		
<b>1815.150:</b>					
0505.018	mm 180	0510.018	mm 180		
0506.017	mm 170	0511.017	mm 170		
<b>1815.180:</b>					
0344.020	mm 2	0344.040	mm 4	0344.080	mm 8
0344.025	mm 2,5	0344.050	mm 5		
0344.030	mm 3	0344.060	mm 6		
<b>1815.200:</b>					
0344.320	mm 2	0344.340	mm 4	0344.380	mm 8
0344.325	mm 2,5	0344.350	mm 5		
0344.330	mm 3	0344.360	mm 6		
<b>1815.220:</b>					
1098.080	mm 8	1098.110	mm 11	1098.170	mm 17
1098.090	mm 9	1098.130	mm 13	1098.190	mm 19
1098.100	mm 10	1098.140	mm 14		
<b>1815.260:</b>					
1055.080	mm 8	1055.120	mm 12	1055.170	mm 17
1055.100	mm 10	1055.130	mm 13	1055.190	mm 19
1055.110	mm 11	1055.140	mm 14		
<b>1815.300:</b>					
0560.025	mm 250	1070.020	mm 200		
0683.010		0620.010			
<b>1815.380:</b>					
1150.080	mm 8	1150.130	mm 13		
1150.100	mm 10	1150.170	mm 17		

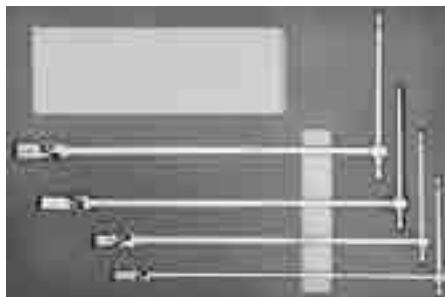

1815.380

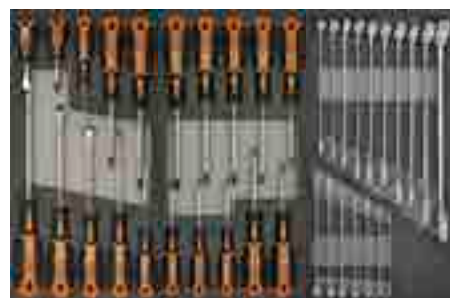

1815.010 1815.020 1815.040



1815.050 1815.070 1815.090



1815.100 1815.120 1815.140



1815.150 1815.180 1815.200



1815.220 1815.260 1815.300

 **1810.185** 700 x 470 x 990

 81300

 8011578810122

**1814.185** ASSORT. 185 UTENSILI - 16 moduli  
 SET 185 TOOLS - 16 modules

 **1814.185**

 22300

 8011578949105

Contenuto-content:

- 1815.010 1815.070 1815.140 1815.220
- 1815.020 1815.090 1815.150 1815.260
- 1815.040 1815.100 1815.180 1815.300
- 1815.050 1815.120 1815.200 1815.380



# 1810.216

## CARRELLO CON 216 UTENSILI - 11 moduli TROLLEY WITH 216 TOOLS - 11 modules



<b>1815.010:</b>					
0050.307	3 x 75	0050.815	8 x 150	0055.603	6 x 38
0050.410	4 x 100	0052.006	PH 0 x 60	0056.103	PH 1 x 38
0050.510	5,5 x 100	0052.108	PH 1 x 80		
0050.612	6,5 x 125	0052.210	PH 2 x 100		
<b>1815.020:</b>					
0075.060	TX 6	0075.100	TX 10	0075.027	TX 27
0075.070	TX 7	0075.015	TX 15	0075.030	TX 30
0075.080	TX 8	0075.020	TX 20		
0075.090	TX 9	0075.025	TX 25		
<b>1815.040:</b>					
1030.060	mm 6	1030.120	mm 12	1030.180	mm 18
1030.070	mm 7	1030.130	mm 13	1030.190	mm 19
1030.080	mm 8	1030.140	mm 14	1030.200	mm 20
1030.090	mm 9	1030.150	mm 15	1030.220	mm 22
1030.100	mm 10	1030.160	mm 16	1030.240	mm 24
1030.110	mm 11	1030.170	mm 17		
<b>1815.090:</b>					
1400.040	mm 4	1400.120	mm 12	1438.200	TX 20
1400.045	mm 4,5	1400.130	mm 13	1438.250	TX 25
1400.050	mm 5	1436.030	mm 3	1438.270	TX 27
1400.055	mm 5,5	1436.040	mm 4	1438.300	TX 30
1400.060	mm 6	1436.050	mm 5	1438.400	TX 40
1400.070	mm 7	1436.060	mm 6	1405.010	
1400.080	mm 8	1436.080	mm 8	1408.075	mm 75
1400.090	mm 9	1438.080	TX 8	1408.150	mm 150
1400.100	mm 10	1438.100	TX 10	1410.010	
1400.110	mm 11	1438.150	TX 15	1412.010	
0351.090	mm 1,5-2-2,5-3-4-5-6-8-10				
0366.090	TX 10-15-20-25-27-30-40-45-50				
<b>1815.095:</b>					
0249.400	mm 4x25	0255.300	TX 30x25	0263.950	mm 5x50
0249.500	mm 5x25	0255.400	TX 40x25	0263.960	mm 6x50
0249.600	mm 6x25	0263.015	mm 1,5x25	0245.100	PH 1x75
0250.100	PH 1x25	0263.020	mm 2x25	0245.200	PH 2x75
0250.200	PH 2x25	0263.025	mm 2,5x25	0245.109	PH 1x90
0250.300	PH 3x25	0263.030	mm 3x25	0245.209	PH 2x90
0251.100	PZ 1x25	0263.040	mm 4x25	0246.100	PZ 1x75
0251.200	PZ 2x25	0263.050	mm 5x25	0246.109	PZ 1x90
0251.300	PZ 3x25	0263.060	mm 6x25	0246.200	PZ 2x75
0253.060	TX 6x25	1420.010		0246.209	PZ 2x90
0253.070	TX 7x25	0084.010		1407.010	
0253.080	TX 8x25	0250.910	PH 1x25 T	0258.910	PZ 1x50 T
0253.090	TX 9x25	0250.920	PH 2x25 T	0258.920	PZ 2x50 T
0253.100	TX 10x25	0250.930	PH 3x25 T	0258.910	PZ 1x50 T
0253.150	TX 15x25	0251.910	PZ 1x25 T	0258.920	PZ 2x50 T
0253.200	TX 20x25	0251.920	PZ 2x25 T	0255.906	TX 6x50
0253.250	TX 25x25	0251.930	PZ 3x25 T	0255.907	TX 7x50
0253.270	TX 27x25	0258.100	PZ 1x50	0255.908	TX 8x50
0253.300	TX 30x25	0258.200	PZ 2x50	0255.909	TX 9x50
0255.060	TX 6x25	0258.300	PZ 3x50	0255.910	TX 10x50
0255.070	TX 7x25	0260.100	PH 1x50	0255.915	TX 15x50
0255.080	TX 8x25	0260.200	PH 2x50	0255.920	TX 20x50
0255.090	TX 9x25	0260.300	PH 3x50	0255.925	TX 25x50
0255.100	TX 10x25	0262.400	mm 4x50	0255.927	TX 27x50
0255.150	TX 15x25	0262.500	mm 5x50	0255.930	TX 30x50
0255.200	TX 20x25	0262.600	mm 6x50	0255.940	TX 40x50
0255.250	TX 25x25	0263.930	mm 3x50		
0255.270	TX 27x25	0263.940	mm 4x50		
<b>1815.100:</b>					
1500.080	mm 8	1500.160	mm 16	1500.270	mm 27
1500.090	mm 9	1500.170	mm 17	1500.300	mm 30
1500.100	mm 10	1500.180	mm 18	1500.320	mm 32
1500.110	mm 11	1500.190	mm 19	1505.010	
1500.120	mm 12	1500.200	mm 20	1508.125	mm 125
1500.130	mm 13	1500.210	mm 21	1508.250	mm 250
1500.140	mm 14	1500.220	mm 22	1510.010	
1500.150	mm 15	1500.240	mm 24	1512.010	
<b>1815.120:</b>					
0377.030	gr 300	0616.015	mm 150		
0370.035	mm 35	0612.016	mm 160		
<b>1815.140:</b>					
0440.918	mm 180	0463.916	mm 160	0490.024	mm 240
0412.916	mm 160	0474.025	mm 250		
<b>1815.150:</b>					
0505.018	mm 180	0510.018	mm 180		
0506.017	mm 170	0511.017	mm 170		
<b>1815.180:</b>					
0344.020	mm 2	0344.040	mm 4	0344.080	mm 8
0344.025	mm 2,5	0344.050	mm 5		
0344.030	mm 3	0344.060	mm 6		
<b>1815.330:</b>					
0574.090	0574.290	0574.490			
0574.190	0574.390				

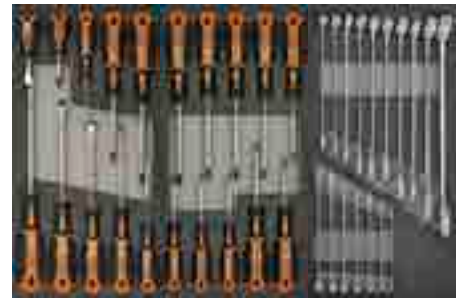

1815.010 1815.020 1815.040



1815.090 1815.095 1815.100



1815.120 1815.140 1815.150



1815.180 1815.330

Contenuto-content:

- 1810.210
- 1815.010
- 1815.020
- 1815.040
- 1815.090
- 1815.095
- 1815.100
- 1815.120
- 1815.140
- 1815.150
- 1815.180
- 1815.330

 **1810.216** 700 x 470 x 990

   
 74890 8011578970062

**new**

# 1814.216

## ASSORTIMENTO 216 UTENSILI - 11 moduli SET 216 TOOLS - 11 modules

 **1814.216**

   
 14893 8011578970109

**new**

Contenuto-content:



- 1815.010 1815.095 1815.150
- 1815.020 1815.100 1815.180
- 1815.040 1815.120 1815.330
- 1815.090 1815.140

**1815.010** MODULO 10 GIRAVITI  
 MODULE 10 SCREWDRIVERS



Contenuto-content:

0050.307	3 x 75	0052.006	PH 0 x 60
0050.410	4 x 100	0052.108	PH 1 x 80
0050.510	5,5 x 100	0052.210	PH 2 x 100
0050.612	6,5 x 125	0055.603	6 x 38
0050.815	8 x 150	0056.103	PH 1 x 38



			
<b>1815.010</b>	370 x 188 x 30	735	8011578815004
<b>1815.012</b>	vuoto - empty	46	8011578815028

**1815.050** MODULO 3 CHIAVI COMB. GRANDI  
 MODULE 3 COMB. BIG WRENCHES



Contenuto-content:

1030.270	mm 27
1030.300	mm 30
1030.320	mm 32

			
<b>1815.050</b>	370 x 188 x 30	1322	8011578815127
<b>1815.052</b>	vuoto - empty	60	8011578815141

**1815.020** MODULO 10 GIRAVITI TORX  
 MODULE 10 TORX SCREWDRIVERS



Contenuto-content:

0075.060	TX 6	0075.015	TX 15
0075.070	TX 7	0075.020	TX 20
0075.080	TX 8	0075.025	TX 25
0075.090	TX 9	0075.027	TX 27
0075.100	TX 10	0075.030	TX 30

			
<b>1815.020</b>	370 x 188 x 30	620	8011578815042
<b>1815.022</b>	vuoto - empty	46	8011578815066

**1815.070** MOD. 8 CHIAVI FORCH. + 9 ES. (17)  
 MOD. 8 OPEN WR. + 9 HEX (17)



Contenuto-content:

1020.067	mm 6x7	1020.145	mm 14x15
1020.089	mm 8x9	1020.167	mm 16x17
1020.101	mm 10x11	1020.189	mm 18x19
1020.123	mm 12x13	1020.202	mm 20x22
0347.090	mm 1,5-2-2,5-3-4-5-6-8-10		





			
<b>1815.070</b>	370 x 188 x 30	1115	8011578815165
<b>1815.072</b>	vuoto - empty	46	8011578815189

**1815.040** MODULO 17 CHIAVI COMBINATE  
 MODULE 17 COMB. WRENCHES



Contenuto-content:

1030.060	mm 6	1030.120	mm 12	1030.180	mm 18
1030.070	mm 7	1030.130	mm 13	1030.190	mm 19
1030.080	mm 8	1030.140	mm 14	1030.200	mm 20
1030.090	mm 9	1030.150	mm 15	1030.220	mm 22
1030.100	mm 10	1030.160	mm 16	1030.240	mm 24
1030.110	mm 11	1030.170	mm 17		

			
<b>1815.040</b>	370 x 188 x 30	1860	8011578815080
<b>1815.042</b>	vuoto - empty	54	8011578815103

**1815.080** MOD. 4 CHIAVI FORCHETTA GRANDI  
 MODULE 4 OPEN BIG WRENCHES



Contenuto-content:

1020.213	mm 21x23
1020.247	mm 24x27
1020.258	mm 25x28
1020.302	mm 30x32

			
<b>1815.080</b>	370 x 188 x 30	1414	8011578815202
<b>1815.082</b>	vuoto - empty	60	8011578815226

**1815.083** MODULO 8 CHIAVI POLIGONALI  
 MOD. 8 OFFSET DOUBLE RING WR.



Contenuto-content:

- 1025.067 6-7
- 1025.089 8-9
- 1025.101 10-11
- 1025.123 12-13
- 1025.145 14-15
- 1025.167 16-17
- 1025.189 18-19
- 1025.202 20-22

				
<b>1815.083</b>	370 x 188 x 30	<b>new</b>	1400	8011578969325
<b>1815.084</b>	vuoto - empty		57	8011578969349

**1815.086** MODULO 20 CHIAVI TORX  
 MODULE 20 TORX WRENCHES



Contenuto-content:

- 1048.068 E 6 x E 8
- 1048.102 E 10 x E 12
- 1048.148 E 14 x E 18
- 1048.204 E 20 x E 24
- 1404.040 1/4" TX E 4 FEM
- 1404.050 1/4" TX E 5 FEM
- 1404.060 1/4" TX E 6 FEM
- 1404.070 1/4" TX E 7 FEM
- 1404.080 1/4" TX E 8 FEM
- 1404.100 1/4" TX E 10 FEM
- 1535.100 1/2" TX E 10 FEM
- 1535.120 1/2" TX E 12 FEM
- 1535.140 1/2" TX E 14 FEM
- 1535.160 1/2" TX E 16 FEM
- 1535.180 1/2" TX E 18 FEM
- 1535.200 1/2" TX E 20 FEM
- 1535.240 1/2" TX E 24 FEM
- 0366.090 TX 10-15-20-25-27-30-40-45-50

				
<b>1815.086</b>	370 x 188 x 30	<b>new</b>	1200	8011578969363
<b>1815.087</b>	vuoto - empty		57	8011578969387

**1815.090** MOD. 30 BUS. 1/4" + 9 ES. + 9 TX (48)  
 MOD. 30 SOCK. 1/4" + 9 HEX + 9 TX (48)

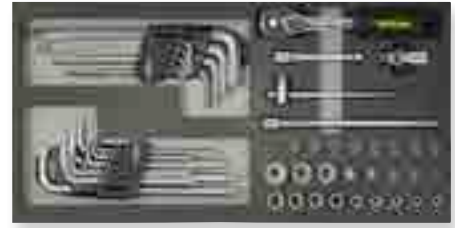

Contenuto-content:

- |  |                |                 |
|--|----------------|-----------------|
| 1400.040 mm 4                          | 1400.120 mm 12 | 1438.200 TX 20  |
| 1400.045 mm 4,5                        | 1400.130 mm 13 | 1438.250 TX 25  |
| 1400.050 mm 5                          | 1436.030 mm 3  | 1438.270 TX 27  |
| 1400.055 mm5,5                         | 1436.040 mm 4  | 1438.300 TX 30  |
| 1400.060 mm 6                          | 1436.050 mm 5  | 1438.400 TX 40  |
| 1400.070 mm 7                          | 1436.060 mm 6  | 1405.010        |
| 1400.080 mm 8                          | 1436.080 mm 8  | 1408.075 mm 75  |
| 1400.090 mm 9                          | 1438.080 TX 8  | 1408.150 mm 150 |
| 1400.100 mm 10                         | 1438.100 TX 10 | 1410.010        |
| 1400.110 mm 11                         | 1438.150 TX 15 | 1412.010        |
| 0351.090 mm 1,5-2-2,5-3-4-5-6-8-10     |                |                 |
| 0366.090 TX 10-15-20-25-27-30-40-45-50 |                |                 |

			
<b>1815.090</b>	370 x 188 x 30	1442	8011578815240
<b>1815.092</b>	vuoto - empty	50	8011578815264

**1815.095** MODULO 82 INSERTI  
 MODULE 82 BITS



Contenuto-content:

- |                   |                    |                    |
|-------------------|--------------------|--------------------|
| 0249.400 mm 4x25  | 0255.300 TX 30x25  | 0263.950 mm 5x50   |
| 0249.500 mm 5x25  | 0255.400 TX 40x25  | 0263.960 mm 6x50   |
| 0249.600 mm 6x25  | 0263.015 mm 1.5x25 | 0245.100 PH 1x75   |
| 0250.100 PH 1x25  | 0263.020 mm 2x25   | 0245.200 PH 2x75   |
| 0250.200 PH 2x25  | 0263.025 mm 2.5x25 | 0245.109 PH 1x90   |
| 0250.300 PH 3x25  | 0263.030 mm 3x25   | 0245.209 PH 2x90   |
| 0251.100 PZ 1x25  | 0263.040 mm 4x25   | 0246.100 PZ 1x75   |
| 0251.200 PZ 2x25  | 0263.050 mm 5x25   | 0246.109 PZ 1x90   |
| 0251.300 PZ 3x25  | 0263.060 mm 6x25   | 0246.200 PZ 2x75   |
| 0253.060 TX 6x25  | 1420.010           | 0246.209 PZ 2x90   |
| 0253.070 TX 7x25  | 0084.010           | 1407.010           |
| 0253.080 TX 8x25  | 0250.910 PH 1x25 T | 0258.910 PZ 1x50 T |
| 0253.090 TX 9x25  | 0250.920 PH 2x25 T | 0258.920 PZ 2x50 T |
| 0253.100 TX 10x25 | 0250.930 PH 3x25 T | 0258.910 PZ 1x50 T |
| 0253.150 TX 15x25 | 0251.910 PZ 1x25 T | 0258.920 PZ 2x50 T |
| 0253.200 TX 20x25 | 0251.920 PZ 2x25 T | 0255.906 TX 6x50   |
| 0253.250 TX 25x25 | 0251.930 PZ 3x25 T | 0255.907 TX 7x50   |
| 0253.270 TX 27x25 | 0258.100 PZ 1x50   | 0255.908 TX 8x50   |
| 0253.300 TX 30x25 | 0258.200 PZ 2x50   | 0255.909 TX 9x50   |
| 0255.060 TX 6x25  | 0258.300 PZ 3x50   | 0255.910 TX 10x50  |
| 0255.070 TX 7x25  | 0260.100 PH 1x50   | 0255.915 TX 15x50  |
| 0255.080 TX 8x25  | 0260.200 PH 2x50   | 0255.920 TX 20x50  |
| 0255.090 TX 9x25  | 0260.300 PH 3x50   | 0255.925 TX 25x50  |
| 0255.100 TX 10x25 | 0262.400 mm 4x50   | 0255.930 TX 27x50  |
| 0255.150 TX 15x25 | 0262.500 mm 5x50   | 0255.930 TX 30x50  |
| 0255.200 TX 20x25 | 0262.600 mm 6x50   | 0255.940 TX 40x50  |
| 0255.250 TX 25x25 | 0263.930 mm 3x50   |                    |
| 0255.270 TX 27x25 | 0263.940 mm 4x50   |                    |

				
<b>1815.095</b>	370 x 188 x 30	<b>new</b>	900	8011578969448
<b>1815.096</b>	vuoto - empty		57	8011578969462





**1815.100** MODULO 24 BUSSOLE 1/2"  
 MODULE 24 SOCKETS 1/2"



Contenuto-content:

1500.080	mm 8	1500.240	mm 24
1500.090	mm 9	1500.270	mm 27
1500.100	mm 10	1500.300	mm 30
1500.110	mm 11	1500.320	mm 32
1500.120	mm 12	1505.010	
1500.130	mm 13	1508.125	mm 125
1500.140	mm 14	1508.250	mm 250
1500.150	mm 15	1510.010	
1500.160	mm 16	1512.010	
1500.170	mm 17		
1500.180	mm 18		
1500.190	mm 19		
1500.200	mm 20		
1500.210	mm 21		
1500.220	mm 22		

	←-L-→		
<b>1815.100</b>	370 x 188 x 30	3500	8011578815288
<b>1815.102</b>	vuoto - empty	54	8011578815301

**1815.105** MOD. 24 BUSSOLE 1/2" in POLLICI  
 MOD. 24 SOCKETS 1/2" in INCH

1/2"



Contenuto-content:

1504.010	3/8"	1510.010	
1504.020	7/16"	1512.010	
1504.030	1/2"	1525.010	
1504.040	9/16"	1525.015	
1504.050	5/8"		
1504.060	19/32"		
1504.070	11/16"		
1504.080	3/4"		
1504.090	25/32"		
1504.100	13/16"		
1504.110	7/8"		
1504.120	15/16"		
1504.130	1"		
1504.140	1.1/16"		
1504.150	1.1/8"		
1504.160	1.3/16"		
1504.170	1.1/4"		
1505.010			
1508.125	mm 125		
1508.250	mm 250		



	←-L-→		
<b>1815.105</b>	370 x 188 x 30	<b>new</b> 3500	8011578962524

**1815.120** MOD. 4 MART. MAZZUOLA SCALPELLI  
 MOD. 4 HAMMERS - MALLET - CHISELS



Contenuto-content:

0377.030	gr 300
0370.035	mm 35
0616.015	mm 150
0612.016	mm 160

	←-L-→		
<b>1815.120</b>	370 x 188 x 30	1170	8011578815325
<b>1815.122</b>	vuoto - empty	52	8011578815349

**1815.140** MODULO 5 PINZE  
 MODULE 5 PLIERS



Contenuto-content:

0440.918	mm 180	0474.025	mm 250
0412.916	mm 160	0490.024	mm 240
0463.916	mm 160		

	←-L-→		
<b>1815.140</b>	370 x 188 x 30	1600	8011578815363
<b>1815.142</b>	vuoto - empty	48	8011578815387

**1815.150** MODULO 4 PINZE ANELLI  
 MODULE 4 CIRCLIP PLIERS



Contenuto-content:

0505.018	mm 180	0510.018	mm 180
0506.017	mm 170	0511.017	mm 170

	←-L-→		
<b>1815.150</b>	370 x 188 x 30	1620	8011578815400
<b>1815.152</b>	vuoto - empty	68	8011578815424

## 1815.180 MODULO 7 CHIAVI "T" IMPUGNATURA

### MODULE 7 "T" HANDLE WRENCHES

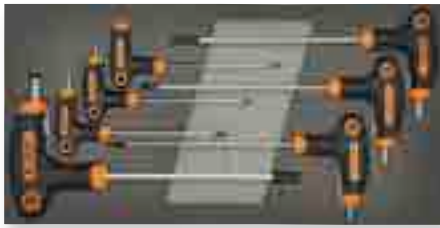

Contenuto-content:

0344.020 mm 2	0344.050 mm 5
0344.025 mm 2,5	0344.060 mm 6
0344.030 mm 3	0344.080 mm 8
0344.040 mm 4	



<b>1815.180</b>	370 x 188 x 30	546	8011578815448
<b>1815.182</b>	vuoto - empty	61	8011578815462

## 1815.220 MODULO 8 CHIAVI PIPA

### MOD. 8 ANGLE OPEN WRENCHES



Contenuto-content:

1098.080 mm 8	1098.130 mm 13
1098.090 mm 9	1098.140 mm 14
1098.100 mm 10	1098.170 mm 17
1098.110 mm 11	1098.190 mm 19



<b>1815.220</b>	370 x 188 x 30	1596	8011578815523
<b>1815.222</b>	vuoto - empty	60	8011578815547

## 1815.200 MOD. 7 CHIAVI TRE TESTE ESAGONO

### MOD. 7 THREE HEAD HEX. WRENCHES

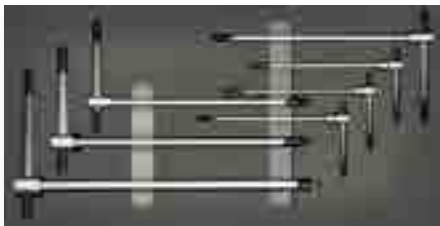

Contenuto-content:

0344.320 mm 2	0344.340 mm 4	0344.380 mm 8
0344.325 mm 2,5	0344.350 mm 5	
0344.330 mm 3	0344.360 mm 6	



<b>1815.200</b>	370 x 188 x 30	658	8011578815486
<b>1815.202</b>	vuoto - empty	46	8011578815509

## 1815.240 MOD. 8 CHIAVI CRICCHETTO REVERS.

### MOD. 8 REV. RATCHET WRENCHES



Contenuto-content:

1060.080 mm 8	1060.130 mm 13
1060.100 mm 10	1060.140 mm 14
1060.110 mm 11	1060.170 mm 17
1060.120 mm 12	1060.190 mm 19



<b>1815.240</b>	370 x 188 x 30	992	8011578815561
<b>1815.242</b>	vuoto - empty	46	8011578815585

## 1815.210 MODULO 7 CHIAVI TRE TESTE TORX

### MOD. 7 TORX THREE H. WRENCHES

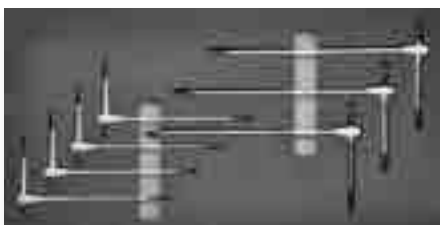

Contenuto-content:

0344.408 TX 8	0344.420 TX 20	0344.430 TX 30
0344.410 TX 10	0344.425 TX 25	
0344.415 TX 15	0344.427 TX 27	



<b>1815.210</b>	370 x 188 x 30	348	8011578949648
<b>1815.212</b>	vuoto - empty	68	8011578949662

## 1815.260 MOD. 8 CHIAVI CRICCHETTO SNOD.

### MOD. 8 FLEX RATCHET WRENCHES



Contenuto-content:

1055.080 mm 8	1055.130 mm 13
1055.100 mm 10	1055.140 mm 14
1055.110 mm 11	1055.170 mm 17
1055.120 mm 12	1055.190 mm 19





<b>1815.260</b>	370 x 188 x 30	1132	8011578815608
<b>1815.262</b>	vuoto - empty	46	8011578815622

**1815.300** MOD. 4 CESOIA FORB. SCALP. CHIAVE  
 MOD. 4 SNIPS-SCIS.-WRENCH-CHISEL



Contenuto-content:  
 0560.025 mm 250 1070.020 mm 200  
 0683.010 0620.010

			
<b>1815.300</b>	370 x 188 x 30	1400	8011578815646
<b>1815.302</b>	vuoto - empty	50	8011578815660

**1815.330** MODULO 5 LIME  
 MODULE 5 FILES



Contenuto-content:  
 0574.090  
 0574.190  
 0574.290  
 0574.390  
 0574.490

			
<b>1815.330</b>	370 x 188 x 30 <b>new</b>	900	8011578969400
<b>1815.332</b>	vuoto - empty	57	8011578969424

**1815.380** MOD. GRANDE 4 CHIAVI A "T" SNOD.  
 MOD. BIG 4 "T" CARD. WRENCHES

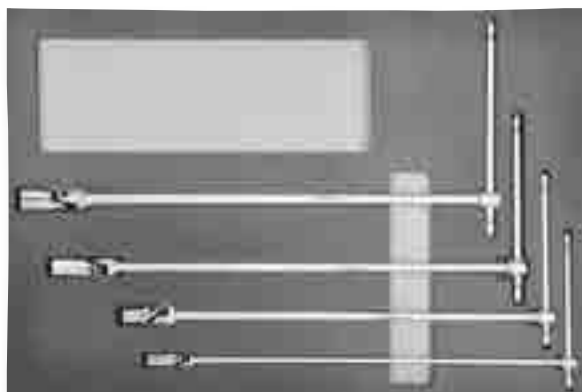

Contenuto-content:  
 1150.080 mm 8 1150.130 mm 13  
 1150.100 mm 10 1150.170 mm 17

			
<b>1815.380</b>	370 x 550 x 30	1700	8011578815684
<b>1815.382</b>	vuoto - empty	200	8011578815707

**1815.400** MODULO 8 CHIAVI "T" SNODATE  
 MODULE 8 "T" CARD. WRENCHES



Contenuto-content:  
 1150.070 mm. 7  
 1150.080 mm. 8  
 1150.100 mm.10  
 1150.120 mm.12  
 1150.130 mm.13  
 1150.140 mm.14  
 1150.170 mm.17  
 1150.190 mm.19

			
<b>1815.400</b>	370 x 188 x 30 <b>new</b>	3200	8011578969486
<b>1815.402</b>	vuoto - empty	200	8011578969509

**1815.500** MOD. 22 CHIAVI BUSSOLA 1/4" - 1/2"  
 MOD. 22 SOCKETS 1/4" - 1/2"

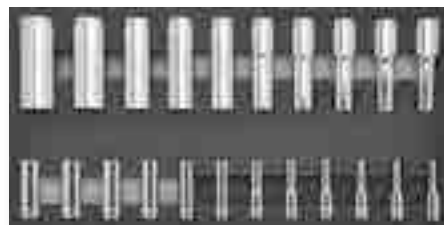

Contenuto-content:  
 1402.040 4  
 1402.045 4,5  
 1402.050 5  
 1402.055 5,5  
 1402.060 6  
 1402.070 7  
 1402.080 8  
 1402.090 9  
 1402.100 10  
 1402.110 11  
 1402.120 12  
 1402.130 13  
 1502.100 10  
 1502.110 11  
 1502.120 12  
 1502.130 13  
 1502.140 14  
 1502.150 15  
 1502.170 17  
 1502.190 19  
 1502.220 22  
 1502.240 24

			
<b>1815.500</b>	370 x 188 x 30	1770	8011578949686
<b>1815.502</b>	vuoto - empty	57	8011578949709

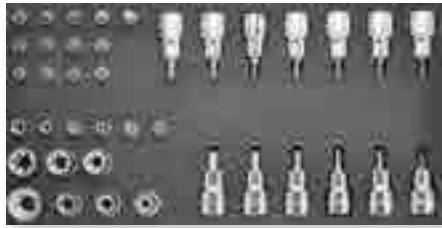
**1815.540**
**MOD. 39 BUSS. TORX-ES. 1/4" - 1/2"**  
 MOD. 39 TORX-HEX SOCKETS 1/4" - 1/2"

Contenuto-content:

1436.030 mm 3	1534.200 TX 20	1535.100 10
1436.040 mm 4	1534.250 TX 25	1535.120 12
1436.050 mm 5	1534.270 TX 27	1535.140 14
1436.060 mm 6	1534.300 TX 30	1535.160 16
1436.080 mm 8	1534.400 TX 40	1535.180 18
1438.080 TX 8	1534.450 TX 45	1535.200 20
1438.100 TX 10	1534.500 TX 50	1535.240 24
1438.150 TX 15	1404.040 E 4	1530.040 4
1438.200 TX 20	1404.050 E 5	1530.050 5
1438.250 TX 25	1404.060 E 6	1530.060 6
1438.270 TX 27	1404.070 E 7	1530.080 8
1438.300 TX 30	1404.080 E 8	1530.100 10
1438.400 TX 40	1404.100 E 10	1530.120 11

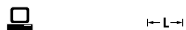
**1815.540** 370 x 188 x 30

1788

8011578949723

**1815.542** vuoto - empty

66

8011578949747

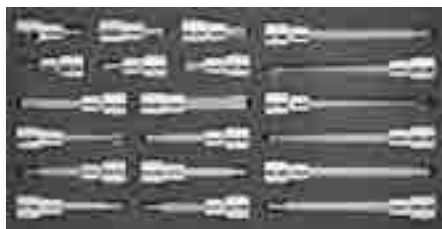
**1815.580**
**MODULO 20 BUSS. ES-TX-XZN 1/2"**  
 MOD. 20 HEX-TX-XZN SOCKETS 1/2"

Contenuto-content:

1531.050 5	1537.040 M 4
1531.060 6	1537.050 M 5
1531.080 8	1537.060 M 6
1531.206 6	1537.080 M 8
1531.208 8	1537.100 M 10
1531.210 10	1537.120 M 12
1534.840 TX 40	
1534.845 TX 45	
1534.850 TX 50	
1534.855 TX 55	
1534.860 TX 60	
1534.940 TX 40	
1534.950 TX 50	
1534.955 TX 55	

**1815.580** 370 x 188 x 30

2306

8011578949761

**1815.582** vuoto - empty

57

8011578949785

**1815.590**
**MODULO 18 BUSSOLE IMPACT**  
 MODULE 18 IMPACT SOCKETS

Contenuto-content:

1650.120 mm 12
1650.130 mm 13
1650.140 mm 14
1650.150 mm 15
1650.160 mm 16
1650.170 mm 17
1650.180 mm 18
1650.190 mm 19
1650.210 mm 21
1650.220 mm 22
1650.240 mm 24
1650.270 mm 27
1652.130 mm 13
1652.170 mm 17
1652.190 mm 19
1652.220 mm 22
1652.240 mm 24
1653.012

**1815.590** 370 x 188 x 30

new

2300

8011578969523

**1815.592** vuoto - empty

57

8011578969547

**1815.595**
**MODULO 7 UTENSILI ISOLATI**  
 MODULE 7 INSULATED TOOLS

**60900**

Contenuto-content:

0710.018 mm. 180
0716.016 mm. 160
0090.310 3,0x100
0090.410 4,0x100
0090.615 6,5x150
0092.110 PH 1x100
0092.210 PH 2x100

**1815.595** 370 x 188 x 30

new

800

8011578969561

**1815.596** vuoto - empty

57

8011578969585

**1820** FLESSOMETRO - gommato  
 TAPE RULE - rubber



	←-L-→			
<b>1820.030</b>	mt. 3	126	<b>12</b>	8011578920005
<b>1820.050</b>	mt. 5	188	<b>12</b>	8011578920029

**1844** CUTTER GUIDA IN FERRO - con 3 lame mm 18  
 CUTTER - with 3 blades mm 18



	←-L-→			
<b>1844.010</b>	180	116	<b>12</b>	8011578932237

**1820.912** ESP. IN CARTONE 12 FLESSOMETRI  
 CART. DESK DISPLAY 12 TAPE RULES



Contenuto-content:  
 1820.030 Nr. 6  
 1820.050 Nr. 6

	←-L-→			
<b>1820.912</b>	280 x 190 x 80	2300		8011578949129

**1844.900** ESP. IN CARTONE 12 CUTTER  
 CARTON DESK DISPLAY 12 CUTTERS



Contenuto-content:  
 1844.010 Nr. 12

	←-L-→			
<b>1844.900</b>	200 x 140 x 90	1250	<b>12</b>	8011578945640

**1830** MATITA  
 PENCIL



	←-L-→			
<b>1830.010</b>	180	8	<b>24</b>	8011578932145

**1845** LAMA PER CUTTER  
 BLADE FOR CUTTER



prezzo per una lama  
 price for one blade

	←-L-→			
<b>1845.010</b>	18	6	<b>10</b>	8011578932268

**1835** SPAZZOLINO IN OTTONE  
 SMALL BRASS BRUSH



	←-L-→			
<b>1835.010</b>	145	24	<b>12</b>	8011578932176



punto vendita - sales point  
**mundial merchandising**  
 esposizione a libero servizio - self-service exhibition



**Utensili in confezione appendibile self-service con codice a barre**

Bar code for hanged self-service packaging



0050.307-9	3,0 x 75	8011578955007
0050.310-9	3,0 x 100	8011578955038
0050.410-9	4,0 x 100	8011578955090
0050.412-9	4,0 x 125	8011578955120
0050.510-9	5,5 x 100	8011578955151
0050.512-9	5,5 x 125	8011578955182
0050.515-9	5,5 x 150	8011578955212
0050.610-9	6,5 x 100	8011578955243
0050.612-9	6,5 x 125	8011578955274
0050.615-9	6,5 x 150	8011578955304
0050.815-9	8,0 x 150	8011578955335
0050.820-9	8,0 x 200	8011578955366
0050.920-9	10,0 x 200	8011578955380
0051.256-9	2,5 x 60	8011578955397
0051.310-9	3,0 x 100	8011578955427
0051.412-9	4,0 x 125	8011578955458
0051.415-9	4,0 x 150	8011578955489
0051.515-9	5,0 x 150	8011578955540

0053.315-9	PZ 3 x 150-8	8011578955939
0055.403-9	5,0 x 38	8011578955960
0055.603-9	6,5 x 38	8011578955991
0056.103-9	PH 1 x 38-4,5	8011578956028
0056.203-9	PH 2 x 38-6	8011578956059
0057.103-9	PZ 1 x 38-4,5	8011578956080
0057.203-9	PZ 2 x 38-6	8011578956110
0058.330-9	3,0 x 300	8011578956141
0058.430-9	4,0 x 300	8011578956172
0058.440-9	4,0 x 400	8011578956240
0058.530-9	5,0 x 300	8011578956202
0058.630-9	6,0 x 300	8011578956233
0058.640-9	6,0 x 400	8011578956257
0059.030-9	PH 0 x 300-3	8011578956264
0059.130-9	PH 1 x 300-5	8011578956295
0059.140-9	PH 1 x 400	8011578956332
0059.230-9	PH 2 x 300-6	8011578956325
0059.240-9	PH 2 x 400	8011578956349
0072.060-9	TX 6 x 60	8011578956516
0072.070-9	TX 7 x 60	8011578956547
0072.080-9	TX 8 x 60	8011578956578
0072.090-9	TX 9 x 60	8011578956608
0072.100-9	TX 10 x 80	8011578956639
0072.150-9	TX 15 x 80	8011578956660
0072.200-9	TX 20 x 100	8011578956691
0072.250-9	TX 25 x 100	8011578956721
0072.270-9	TX 27 x 100	8011578956752
0072.300-9	TX 30 x 100	8011578956783
0072.400-9	TX 40 x 125	8011578956813
0072.450-9	TX 45 x 125	8011578956844
0075.060-9	TX 6 x 60	8011578956875
0075.070-9	TX 7 x 60	8011578956905
0075.080-9	TX 8 x 60	8011578956936
0075.090-9	TX 9 x 60	8011578956967
0075.100-9	TX 10 x 80	8011578956998

0075.150-9	TX 15 x 80	8011578957025
0075.200-9	TX 20 x 100	8011578957056
0075.250-9	TX 25 x 100	8011578957087
0075.270-9	TX 27 x 100	8011578957117
0075.300-9	TX 30 x 100	8011578957148
0075.400-9	TX40 x 125	8011578957179
0075.450-9	TX 45 x 125	8011578957209
0078.025-9	2,5 x 75	8011578957216
0078.030-9	3 x 75	8011578957230
0078.040-9	4 x 100	8011578957261
0078.050-9	5 x 100	8011578957292
0078.060-9	6 x 125	8011578957322
0080.100-9	SQ 1 x 100	8011578957353
0080.200-9	SQ 2 x 125	8011578957384
0080.300-9	SQ 3 x 150	8011578957414
0082.050-9	mm. 5	8011578957445
0082.055-9	mm. 5,5	8011578957476
0082.060-9	mm. 6	8011578957506
0082.070-9	mm. 7	8011578957537
0082.080-9	mm. 8	8011578957568
0082.090-9	mm. 9	8011578957599
0082.100-9	mm. 10	8011578957629
0082.110-9	mm. 11	8011578957660
0082.120-9	mm. 12	8011578957691
0082.130-9	mm. 13	8011578957721
0084.010-9	1/4"	8011578957752
0087.010-9	1/4"	8011578957803
0087.310-9		8011578952686
0090.258-9	2,5 x 80	8011578957834
0090.310-9	3,0 x 100	8011578957865
0090.410-9	4,0 x 100	8011578957896
0090.512-9	5,5 x 125	8011578957926
0090.615-9	6,5 x 150	8011578957957
0090.817-9	8,0 x 175	8011578957988
0092.007-9	PH 0 x 75	8011578958015



0052.006-9	PH 0 x 60-3	8011578955571
0052.010-9	PH 0 x 100-3	8011578955601
0052.108-9	PH 1 x 80-4,5	8011578955632
0052.112-9	PH 1 x 125-4,5	8011578955663
0052.210-9	PH 2 x 100-6	8011578955694
0052.215-9	PH 2 x 150-6	8011578955724
0052.315-9	PH 3 x 150-8	8011578955755
0053.006-9	PZ 0 x 60-3	8011578955786
0053.108-9	PZ 1 x 80-4,5	8011578955816
0053.112-9	PZ 1 x 125-4,5	8011578955847
0053.210-9	PZ 2 x 100-6	8011578955878
0053.215-9	PZ 2 x 150-6	8011578955908



Utensili in confezione appendibile self-service con codice a barre

Bar code for hanged self-service packaging



0092.110-9	PH 1 x 100	8011578958046
0092.210-9	PH 2 x 100	8011578958077
0092.315-9	PH 3 x 150	8011578958107
0093.007-9	PZ 0 x 75	8011578958138
0093.110-9	PZ 1 x 100	8011578958169
0093.210-9	PZ 2 x 100	8011578958190
0093.315-9	PZ 3 x 150	8011578958220
0115.206-9	mm. 2 x 60	8011578115104
0115.256-9	mm. 2.5 x 60	8011578115159
0115.307-9	mm. 3 x 75	8011578115197
0115.310-9	mm. 3 x 100	8011578115203
0115.410-9	mm. 4 x 100	8011578115289
0115.512-9	mm. 5 x 125	8011578115333
0115.610-9	mm. 6 x 100	8011578115401
0115.612-9	mm. 6 x 125	8011578115425
0115.615-9	mm. 6 x 150	8011578115449
0115.815-9	mm. 8 x 150	8011578115456
0115.920-9	mm. 10 x 200	8011578115609
0116.002-9	PH 00-2 x 60	8011578116064
0116.006-9	PH 0-3 x 60	8011578116088
0116.010-9	PH 0-3 x 100	8011578116095
0116.108-9	PH 1-4.5 x 80	8011578116101
0116.112-9	PH 1-4.5 x 125	8011578116156
0116.210-9	PH 2-6 x 100	8011578116200
0116.215-9	PH 2-6 x 150	8011578116224
0116.315-9	PH 3-8 x 150	8011578116309
0130.307-9	mm. 3 x 75	8011578130053
0130.310-9	mm. 3 x 100	8011578130060
0130.410-9	mm. 4 x 100	8011578130107
0130.412-9	mm. 4 x 125	8011578130152
0130.510-9	mm. 5 x 100	8011578130206
0130.512-9	mm. 5 x 125	8011578130237
0130.515-9	mm. 5 x 150	8011578130251
0130.610-9	mm. 6 x 100	8011578130305
0130.612-9	mm. 6 x 125	8011578130329
0130.615-9	mm. 6 x 150	8011578130336
0130.815-9	mm. 8 x 150	8011578130404
0132.310-9	3 x 100	8011578132095
0132.415-9	4 x 150	8011578132125
0132.515-9	5 x 150	8011578132255
0135.006-9	PH 0-3 x 60	8011578135065
0135.010-9	PH 0-3 x 100	8011578135096
0135.108-9	PH 1-4.5 x 80	8011578135102
0135.112-9	PH 1-4.5 x 125	8011578135157
0135.210-9	PH 2-6 x 100	8011578135201
0135.215-9	PH 2-6 x 150	8011578135256
0135.315-9	PH 3-8 x 150	8011578135300
0136.006-9	PZ 0-3 x 60	8011578136093
0136.108-9	PZ 1-4.5 x 80	8011578136109
0136.112-9	PZ 1-4.5 x 125	8011578136130
0136.210-9	PZ 2-6 x 100	8011578136154
0136.215-9	PZ 2-6 x 150	8011578136185
0136.315-9	PZ 3-8 x 150	8011578136208
0137.140-9	4 x 30	8011578137052
0137.160-9	6 x 30	8011578137083
0137.210-9	PH 1-4.5 x 30	8011578137106
0137.220-9	PH 2-6 x 30	8011578137137
0137.310-9	PZ 1-4.5 x 30	8011578137151
0137.320-9	PZ 2-6 x 30	8011578137182
0138.325-9	3 x 250	8011578138035
0138.430-9	4 x 300	8011578138103
0138.630-9	6 x 300	8011578138202
0139.025-9	PH 0-3 x 250	8011578139032
0139.130-9	PH 1-4.5 x 300	8011578139094
0139.230-9	PH 2-6 x 300	8011578139124
0162.105-9	1.5 x 50	8011578162030
0162.206-9	2 x 50	8011578162054
0162.207-9	2.5 x 50	8011578162078
0162.310-9	3 x 50	8011578162122
0163.005-9	PH 000-2 x 50	8011578163037
0163.006-9	PH 00-2 x 50	8011578163075
0163.015-9	PH 0-3 x 50	8011578163105



0163.906-9	TX 6	8011578163204
0163.907-9	TX 7	8011578163228
0163.908-9	TX 8	8011578163242
0163.909-9	TX 9	8011578163266
0163.910-9	TX 10	8011578163280
0163.915-9	TX 15	8011578163303
0163.920-9	TX 20	8011578163334
0184.307-9	mm. 3 x 75	8011578184100
0184.407-9	mm. 4 x 75	8011578184155
0184.510-9	mm. 5 x 100	8011578184209
0184.612-9	mm. 6 x 125	8011578184254
0186.006-9	PH 0-3 x 60	8011578186005
0186.108-9	PH 1-4.5 x 80	8011578186050
0186.210-9	PH 2-6 x 100	8011578186104
0188.108-9	PZ 1-4.5 x 80	8011578188108
0188.210-9	PZ 2-6 x 100	8011578188153
0206.060-9	PH 2-6 x 60	8011578206000
0222.410-9	mm. 4 X 100	8011578222000
0223.306-9	mm. 3 x 60	8011578223007
0225.410-9	mm. 4 x 100	8011578225001
0232.306-9	mm. 3 x 60	8011578232016
0238.010-9	1/4"	8011578238070
0239.010-9	1/4"	8011578239077
0240.005-9	1/4" mm. 50	8011578240073
0240.010-9	1/4" mm. 75	8011578240059
0240.020-9	1/4" mm. 100	8011578240066
0241.014-9	1/4"	8011578241100
0241.038-9	3/8"	8011578241209
0241.120-9	1/2"	8011578241223
0243.060-9	6	8011578243012
0243.070-9	7	8011578243036
0243.080-9	8	8011578243050
0243.100-9	10	8011578243074
0243.110-9	11	8011578243098
0243.120-9	12	8011578243111
0243.130-9	13	8011578243135
0243.380-9	3/8"	8011578243142
0244.045-9	mm. 4 x 100	8011578244002
0244.055-9	mm. 5 x 100	8011578244026
0244.065-9	mm. 6 x 100	8011578244040
0244.075-9	mm. 7 x 100	8011578244064
0244.085-9	mm. 8 x 100	8011578244088
0244.105-9	mm. 10 x 100	8011578244101
0244.125-9	mm. 12 x 100	8011578244125
0244.135-9	mm. 13 x 100	8011578244149
0245.100-9	PH 1 x 75	8011578245054
0245.109-9	PH 1 x 90	8011578245122
0245.115-9	PH 1 x 150	8011578245146
0245.200-9	PH 2 x 75	8011578245108
0245.209-9	PH 2 x 90	8011578245160
0245.215-9	PH 2 x 150	8011578245184
0246.100-9	PZ 1 x 75	8011578246051
0246.109-9	PZ 1 x 90	8011578246129
0246.115-9	PZ 1 x 150	8011578246143
0246.200-9	PZ 2 x 75	8011578246105
0246.209-9	PZ 2 x 90	8011578246167
0246.215-9	PZ 2 x 150	8011578246181
0249.400-9	4 x 25 - pz 3	8011578249052
0249.500-9	5 x 25 - pz 3	8011578249106
0249.600-9	6 x 25 - pz 3	8011578249151



0250.100-9	PH 1 x 25 - pz 3	8011578250058
0250.200-9	PH 2 x 25 - pz 3	8011578250102
0250.300-9	PH 3 x 25 - pz 3	8011578250157
0250.910-9	PH 1 T. - pz 3	8011578250003
0250.920-9	PH 2 T. - pz 3	8011578250065
0250.930-9	PH 3 T. - pz 3	8011578250089
0251.100-9	PZ 1 x 25 - pz 3	8011578251055
0251.200-9	PZ 2 x 25 - pz 3	8011578251109



0251.300-9	PZ 3 x 25 - pz 3	8011578251154
0251.910-9	PZ 1 T. - pz 3	8011578251079
0251.920-9	PZ 2 T. - pz 3	8011578251093
0251.930-9	PZ 3 T. - pz 3	8011578251123
0253.060-9	TX 6x25 - pz 3	8011578253004
0253.070-9	TX 7x25 - pz 3	8011578253011
0253.080-9	TX 8x25 - pz 3	8011578253035
0253.090-9	TX 9x25 - pz 3	8011578253066
0253.100-9	TX 10x25 - pz 3	8011578253097
0253.150-9	TX 15x25 - pz 3	8011578253127
0253.200-9	TX 20x25 - pz 3	8011578253158
0253.250-9	TX 25x25 - pz 3	8011578253189
0253.270-9	TX 27x25 - pz 3	8011578253219
0253.300-9	TX 30x25 - pz 3	8011578253240
0255.060-9	TX 6x25 - pz 3	8011578255015
0255.070-9	TX 7x25 - pz 3	8011578255039
0255.080-9	TX 8x25 - pz 3	8011578255063
0255.090-9	TX 9x25 - pz 3	8011578255060
0255.100-9	TX 10x25 - pz 3	8011578255091
0255.150-9	TX 15x25 - pz 3	8011578255121
0255.200-9	TX 20x25 - pz 3	8011578255152
0255.250-9	TX 25x25 - pz 3	8011578255183
0255.270-9	TX 27x25 - pz 3	8011578255213
0255.300-9	TX 30x25 - pz 3	8011578255243
0255.400-9	TX 40x25 - pz 3	8011578255275
0255.906-9	TX 6x50 - pz 3	8011578255282
0255.907-9	TX 7x50 - pz 3	8011578255305
0255.908-9	TX 8x50 - pz 3	8011578255329
0255.909-9	TX 9x50 - pz 3	8011578255343
0255.910-9	TX 10x50 - pz 3	8011578255367
0255.915-9	TX 15x50 - pz 3	8011578255381
0255.920-9	TX 20x50 - pz 3	8011578255404
0255.925-9	TX 25x50 - pz 3	8011578255428
0255.927-9	TX 27x50 - pz 3	8011578255442
0255.930-9	TX 30x50 - pz 3	8011578255466
0255.940-9	TX 40x50 - pz 3	8011578255480
0256.100-9	SQ 1x25 - pz 3	8011578256104
0256.200-9	SQ 2x25 - pz 3	8011578256203
0256.300-9	SQ 3x25 - pz 3	8011578256302
0258.100-9	PZ 1x50 - pz 3	8011578258054
0258.200-9	PZ 2x50 - pz 3	8011578258108
0258.300-9	PZ 3x50 - pz 3	8011578258153
0258.400-9	PZ 4x50	8011578258160
0258.910-9	PZ 1x50 T.	8011578258184
0258.920-9	PZ 2x50 T.	8011578258207
0260.100-9	PH 1x50 - pz 3	8011578260057
0260.200-9	PH 2x50 - pz 3	8011578260101
0260.300-9	PH 3x50 - pz 3	8011578260156
0260.400-9	PH 4x50	8011578260163
0260.910-9	PH 1x50 T.	8011578260187
0260.920-9	PH 2x50 T.	8011578260200
0262.400-9	4 x 50 - pz 3	8011578262051
0262.500-9	5 x 50 - pz 3	8011578262105
0262.600-9	6 x 50 - pz 3	8011578262150
0263.010-9	1.5 x 25 - pz 3	8011578263010
0263.020-9	2 x 25 - pz 3	8011578263034
0263.025-9	2.5 x 25 - pz 3	8011578263058
0263.030-9	3 x 25 - pz 3	8011578263102
0263.040-9	4 x 25 - pz 3	8011578263201
0263.050-9	5 x 25 - pz 3	8011578263256
0263.060-9	6 x 25 - pz 3	8011578263300
0263.930-9	3 x 50	8011578263324
0263.940-9	4 x 50	8011578263348
0263.950-9	5 x 50	8011578263362
0263.960-9	6 x 50	8011578263386
0264.010-9		8011578264017
0264.110-9	1/4"	8011578264055
0270.040-9	mm. 4 x 75	8011578270001
0270.050-9	mm. 5 x 75	8011578270025
0270.060-9	mm. 6 x 75	8011578270049
0270.080-9	mm. 8 x 75	8011578270063
0270.100-9	mm. 10 x 75	8011578270087

## Utensili in confezione self-service con codice a barre

## Bar code for hanged self-service packaging



0272.020-9	TX 20 x 75	8011578272005
0272.025-9	TX 25 x 75	8011578272029
0272.027-9	TX 27 x 75	8011578272043
0272.030-9	TX 30 x 75	8011578272067
0272.040-9	TX 40 x 75	8011578272081
0272.045-9	TX 45 x 75	8011578272104
0272.050-9	TX 50 x 75	8011578272128
0272.055-9	TX 55 x 75	8011578272142
0274.005-9	XZN 5 x 75	8011578274009
0274.006-9	XZN 6 x 75	8011578274023
0274.008-9	XZN 8 x 75	8011578274047
0274.010-9	XZN 10 x 75	8011578274061
0274.012-9	XZN 12 x 75	8011578274085
0275.005-9	RIBE 5 x 75	8011578275129
0275.006-9	RIBE 6 x 75	8011578275143
0275.007-9	RIBE 7 x 75	8011578275167
0275.008-9	RIBE 8 x 75	8011578275181
0275.009-9	RIBE 9 x 75	8011578275204
0275.010-9	RIBE 10 x 75	8011578275228
0275.012-9	RIBE 12 x 75	8011578275242
0276.004-9	3/8"-mm. 10	8011578276003
0276.006-9	1/2"-mm. 10	8011578276027
0278.050-9	mm. 5	8011578278014
0278.055-9	mm. 5.5	8011578278038
0278.060-9	mm. 6	8011578278076
0278.070-9	mm. 7	8011578278090
0278.080-9	mm. 8	8011578278113
0278.090-9	mm. 9	8011578278137
0278.100-9	mm. 10	8011578278151
0278.110-9	mm. 11	8011578278182
0278.120-9	mm. 12	8011578278199
0278.130-9	mm. 13	8011578278212
0303.110-9	mm. 8 x 95	8011578303037
0303.210-9	mm. 8 x 95	8011578303051
0304.110-9	mm. 6 x 90	8011578304034
0304.210-9	mm. 6 x 90	8011578304058
0305.110-9	mm. 4 x 65	8011578305031
0305.210-9	mm. 4 x 65	8011578305055
0307.010-9		8011578307004
0310.010-9		8011578310004
0311.010-9		8011578311001
0313.010-9		8011578313005
0316.040-9	4	8011578316037
0316.050-9	5	8011578316051
0316.055-9	5.5	8011578316075
0316.060-9	6	8011578316105
0316.070-9	7	8011578316129
0316.080-9	8	8011578316150
0316.090-9	9	8011578316181
0316.100-9	10	8011578316204
0316.110-9	11	8011578316259
0316.120-9	12	8011578316273
0316.130-9	13	8011578316303
0316.140-9	14	8011578316310
0318.050-9	5	8011578318000
0318.055-9	5.5	8011578318017
0318.060-9	6	8011578318031
0318.070-9	7	8011578318055
0318.080-9	8	8011578318079
0318.090-9	9	8011578318093
0318.100-9	10	8011578318109
0318.110-9	11	8011578318116
0318.120-9	12	8011578318123
0318.130-9	13	8011578318154
0318.140-9	14	8011578318178
0340.015-9	1,5	8011578340025
0340.020-9	2	8011578340032
0340.025-9	2,5	8011578340056
0340.030-9	3	8011578340070
0340.040-9	4	8011578340100
0340.050-9	5	8011578340117
0340.060-9	6	8011578340131



0340.080-9	8	8011578340155
0341.100-9	SQ 1-4 x 100	8011578341008
0341.200-9	SQ 2-5 x 125	8011578341053
0341.300-9	SQ 3-6 x 150	8011578341084
0343.060-9	TX 6	8011578343033
0343.070-9	TX 7	8011578343057
0343.080-9	TX 8	8011578343071
0343.090-9	TX 9	8011578343095
0343.100-9	TX 10	8011578343101
0343.150-9	TX 15	8011578343125
0343.200-9	TX 20	8011578343132
0343.250-9	TX 25	8011578343156
0343.270-9	TX 27	8011578343187
0343.300-9	TX 30	8011578343194
0343.400-9	TX 40	8011578343217
0343.450-9	TX 45	8011578343248
0343.605-9	TX 5	8011578343538
0343.606-9	TX 6	8011578343552
0343.607-9	TX 7	8011578343576
0343.608-9	TX 8	8011578343590
0343.609-9	TX 9	8011578343613
0343.610-9	TX 10	8011578343637
0343.615-9	TX 15	8011578343651
0343.620-9	TX 20	8011578343675
0343.625-9	TX 25	8011578343699
0343.627-9	TX 27	8011578343705
0343.630-9	TX 30	8011578343729
0343.640-9	TX 40	8011578343743



0344.020-9	2	8011578344030
0344.025-9	2,5	8011578344078
0344.030-9	3	8011578344092
0344.040-9	4	8011578344139
0344.050-9	5	8011578344207
0344.060-9	6	8011578344269
0344.080-9	8	8011578344306
0344.100-9	10	8011578344344
0344.206-9	TX 6	8011578344382
0344.207-9	TX 7	8011578344405
0344.208-9	TX 8	8011578344429
0344.209-9	TX 9	8011578344443
0344.210-9	TX 10	8011578344467
0344.215-9	TX 15	8011578344481
0344.220-9	TX 20	8011578344504
0344.225-9	TX 25	8011578344528
0344.227-9	TX 27	8011578344542
0344.230-9	TX 30	8011578344566
0344.240-9	TX 40	8011578344573
0344.320-9	mm. 2	8011578344603
0344.325-9	mm. 2,5	8011578344627
0344.330-9	mm. 3	8011578344641
0344.340-9	mm. 4	8011578344689
0344.350-9	mm. 5	8011578344726
0344.360-9	mm. 6	8011578344764
0344.380-9	mm. 8	8011578344801
0344.391-9	mm. 10	8011578344849
0344.392-9	mm. 12	8011578344863
0344.394-9	mm. 14	8011578344900
0344.406-9	TX 6	8011578344009
0344.407-9	TX 7	8011578344023
0344.408-9	TX 8	8011578344047
0344.409-9	TX 9	8011578344061
0344.410-9	TX 10	8011578344085
0344.415-9	TX 15	8011578344108
0344.420-9	TX 20	8011578344122
0344.425-9	TX 25	8011578344146
0344.427-9	TX 27	8011578344160
0344.430-9	TX 30	8011578344184



0344.440-9	TX 40	8011578344221
0344.445-9	TX 45	8011578344245
0345.015-9	1.5	8011578345006
0345.020-9	2	8011578345037
0345.025-9	2.5	8011578345068
0345.030-9	3	8011578345099
0345.035-9	3.5	8011578345129
0345.040-9	4	8011578345150
0345.050-9	5	8011578345211
0345.060-9	6	8011578345273
0345.070-9	7	8011578345303
0345.080-9	8	8011578345334
0345.100-9	10	8011578345396
0345.120-9	12	8011578345426
0345.140-9	14	8011578345488
0345.170-9	17	8011578345518
0345.190-9	19	8011578345549
0345.220-9	22	8011578345556
0345.240-9	24	8011578345587



0350.015-9	1,5	8011578350031
0350.020-9	2	8011578350055
0350.025-9	2,5	8011578350109
0350.030-9	3	8011578350154
0350.040-9	4	8011578350208
0350.050-9	5	8011578350253
0350.060-9	6	8011578350307
0350.080-9	8	8011578350406
0350.100-9	10	8011578350451
0355.015-9	1.5	8011578355579
0355.020-9	2	8011578355050
0355.025-9	2.5	8011578355104
0355.030-9	3	8011578355159
0355.035-9	3.5	8011578355203
0355.040-9	4	8011578355258
0355.045-9	4.5	8011578355302
0355.050-9	5	8011578355357
0355.055-9	5.5	8011578355401
0355.060-9	6	8011578355456
0355.070-9	7	8011578355500
0355.080-9	8	8011578355609
0355.090-9	9	8011578355654
0355.100-9	10	8011578355708
0360.060-9	TX 6	8011578360009
0360.070-9	TX 7	8011578360030
0360.080-9	TX 8	8011578360061
0360.090-9	TX 9	8011578360092
0360.100-9	TX 10	8011578360122
0360.150-9	TX 15	8011578360153
0360.200-9	TX 20	8011578360184
0360.250-9	TX 25	8011578360214
0360.270-9	TX 27	8011578360245
0360.300-9	TX 30	8011578360276
0360.400-9	TX 40	8011578360306
0360.450-9	TX 45	8011578360337
0360.500-9	TX 50	8011578360351



0370.022-9	mm. 22	8011578370039
0370.028-9	mm. 28	8011578370077
0370.035-9	mm. 35	8011578370091
0370.042-9	mm. 42	8011578370114
0370.050-9	mm. 50	8011578370138
0370.060-9	mm. 60	8011578370152
0371.022-9	22	8011578371104
0371.028-9	28	8011578371203

Utensili in confezione self-service con codice a barre

Bar code for hanged self-service packaging



0371.035-9	35	8011578371302
0371.042-9	42	8011578371357
0371.050-9	50	8011578371388
0371.060-9	60	8011578371500
0372.030-9	300 Din 200	8011578372101
0372.050-9	500 Din 400	8011578372156
0372.080-9	800 Din 600	8011578372200
0373.030-9	gr. 300	8011578373108
0373.050-9	gr. 500	8011578373122
0373.080-9	gr. 800	8011578373153
0373.905-9	gr. 500	8011578373160
0373.908-9	gr. 800	8011578373184
0373.910-9	gr. 1000	8011578373207
0373.915-9	gr. 1500	8011578373221
0374.050-9	gr. 500	8011578374006
0374.060-9	gr. 600	8011578374020
0374.080-9	gr. 800	8011578374044
0374.100-9	gr. 1000	8011578374068
0375.030-9	mm. 30	8011578375003
0375.035-9	mm. 35	8011578375027
0375.040-9	mm. 40	8011578375041
0375.050-9	mm. 50	8011578375065
0375.060-9	mm. 60	8011578375089
0376.035-9	mm. 35	8011578376000
0376.040-9	mm. 40	8011578376024
0376.050-9	mm. 50	8011578376048
0376.060-9	mm. 60	8011578376062
0376.130-9	30	8011578376086
0376.135-9	35	8011578376109
0376.140-9	40	8011578376123
0376.150-9	50	8011578376147
0376.160-9	60	8011578376161
0377.010-9	gr. 100	8011578377106
0377.020-9	gr. 200	8011578377151
0377.030-9	gr. 300	8011578377205
0377.040-9	gr. 400	8011578377250
0377.050-9	gr. 500	8011578377304
0377.060-9	gr. 600	8011578377359
0377.080-9	gr. 800	8011578377403
0377.100-9	gr. 1000	8011578377458
0377.150-9	gr. 1500	8011578377557
0377.200-9	gr. 2000	8011578377601
0378.010-9	gr. 100	8011578378004
0378.020-9	gr. 200	8011578378059
0378.030-9	gr. 300	8011578378103
0378.040-9	gr. 400	8011578378158
0378.050-9	gr. 500	8011578378202
0378.060-9	gr. 600	8011578378257
0378.080-9	gr. 800	8011578378301
0378.100-9	gr. 1000	8011578378356
0378.150-9	gr. 1500	8011578378370
0378.200-9	gr. 2000	8011578378394
0380.020-9	gr. 200	8011578380106
0380.030-9	gr. 300	8011578380151
0380.050-9	gr. 500	8011578380250
0380.080-9	gr. 800	8011578380304
0380.100-9	gr. 1000	8011578380359
0381.030-9	gr. 300	8011578381004
0381.340-9	gr. 400	8011578381097
0382.030-9	gr. 300	8011578382308
0382.040-9	gr. 400	8011578382353
0382.210-9	300/400	8011578382506
0382.925-9	gr. 250	8011578382537
0382.930-9	gr. 300	8011578382551
0382.940-9	gr. 400	8011578382575
0383.080-9	gr. 800	8011578383107
0383.100-9	gr. 1000	8011578383102
0383.908-9	FIB gr. 800	8011578383183
0383.910-9	FIB gr. 1000	8011578383213
0383.912-9	FIB gr. 1250	8011578383244
0384.040-9	gr. 400	8011578384005
0385.040-9	gr. 400	8011578385002



0385.903-9	gr. 300	8011578385026
0385.905-9	gr. 500	8011578385040
0385.908-9	gr. 800	8011578385064
0385.910-9	gr. 1000	8011578385088
0386.010-9	gr. 35	8011578386054
0387.010-9	gr. 85	8011578387006
0387.310-9	gr. 85	8011578387051
0388.010-9	gr. 150	8011578388003
0388.110-9		8011578388300
0388.310-9		8011578388058
0402.035-9	mm. 350	8011578402013
0402.045-9	mm. 450	8011578402006
0402.060-9	mm. 600	8011578402051
0402.075-9	mm. 750	8011578402105
0402.090-9	mm. 900	8011578402129
0403.035-9	mm. 350	8011578403157
0403.045-9	mm. 450	8011578403003
0403.060-9	mm. 600	8011578403058
0403.075-9	mm. 750	8011578403102
0403.090-9	mm. 900	8011578403126
0404.020-9	mm. 200	8011578404000
0405.030-9	mm. 600-12	8011578405007
0405.035-9	mm. 900-14	8011578405021
0407.010-9	mm. 190-6	8011578407001
0408.016-9	mm. 160	8011578408008
0409.018-9	mm. 180	8011578409005
0410.016-9	mm. 160	8011578410001
0412.916-9	mm. 165	8011578412159
0414.015-9	mm. 150	8011578414009
0415.016-9		8011578415006
0416.010-9	mm. 150	8011578416003
0417.020-9	mm. 200	8011578417000
0417.022-9	mm. 220	8011578417055
0417.025-9	mm. 250	8011578417109
0418.022-9	mm. 220	8011578418151
0418.025-9	mm. 250	8011578418205
0418.028-9	mm. 280	8011578418212
0420.022-9	mm. 220	8011578420109
0420.025-9	mm. 250	8011578420154
0420.028-9	mm. 280	8011578420185
0423.018-9	mm. 180	8011578423001
0425.018-9	mm. 180	8011578425050
0425.020-9	mm. 200	8011578425104
0430.010-9		8011578430009
0431.010-9		8011578431006
0432.010-9		8011578432003
0435.010-9	Ø 6.3	8011578435059
0436.010-9	Ø 9.3	8011578436056
0437.010-9		8011578437008
0438.010-9	mm. 180	8011578438050
0438.910-9		8011578438258
0438.930-9	mm. 180	8011578438302
0440.916-9	mm. 160	8011578440053
0440.918-9	mm. 180	8011578440107
0440.920-9	mm. 200	8011578440152
0441.018-9	mm. 180	8011578441005
0456.016-9	mm. 160	8011578456054
0456.018-9	mm. 180	8011578456108
0456.020-9	mm. 200	8011578456153
0462.016-9	mm. 160	8011578462008
0463.916-9	mm. 170	8011578463151
0463.920-9	mm. 200	8011578463205
0466.916-9	mm. 170	8011578466152
0466.920-9	mm. 200	8011578466206
0467.916-9	mm. 160	8011578467258
0469.916-9	mm. 160	8011578469153
0470.016-9	mm. 160	8011578470005
0472.010-9	mm. 240	8011578472009
0474.014-9	mm. 140	8011578474126
0474.018-9	mm. 180	8011578474058
0474.025-9	mm. 250	8011578474102
0476.010-9	mm. 270	8011578476052



0478.010-9	mm. 280	8011578478100
0478.910-9	mm. 280	8011578478117
0479.016-9	mm. 160	8011578479039
0479.020-9	mm. 220	8011578479077



0490.018-9	mm. 180	8011578490058
0490.024-9	mm. 240	8011578490003
0490.030-9	mm. 300	8011578490010
0491.024-9	mm. 240	8011578491000
0491.030-9	mm. 300	8011578491024
0492.018-9	mm. 180	8011578492007
0492.024-9	mm. 240	8011578492021
0492.030-9	mm. 300	8011578492045
0495.024-9	mm. 240	8011578495053
0500.017-9	mm. 175-1"	8011578500030
0500.022-9	mm. 225-1-1/2"	8011578500054
0500.027-9	mm. 270-2"	8011578500078
0500.030-9	mm. 300-2-1/2"	8011578500092
0500.035-9	mm. 350-3"	8011578500115
0501.010-9	mm. 250	8011578501006
0502.025-9	250 1/2"	8011578502058
0502.032-9	320 1"	8011578502102
0502.040-9	400 1-1/2"	8011578502157
0502.054-9	540 2"	8011578502201
0502.065-9	650 3"	8011578502256
0502.725-9	250 1/2"	8011578502300
0502.732-9	320 1"	8011578502324
0502.740-9	400 1-1/2"	8011578502348
0502.754-9	540 2"	8011578502362
0502.765-9	650 3"	8011578502386
0503.030-9	300 1"	8011578503000
0503.041-9	410 1-1/2"	8011578503109
0503.052-9	520 2"	8011578503154
0503.062-9	620 3"	8011578503208
0504.020-9	mm. 200-8"	8011578504205
0504.025-9	mm. 250-10"	8011578504250
0504.030-9	mm. 300-12"	8011578504304
0504.035-9	mm. 350-14"	8011578504359
0504.045-9	mm. 450-18"	8011578504458
0504.060-9	mm. 600-24"	8011578504601
0504.090-9	mm. 900-36"	8011578504779
0504.118-9	18"-450	8011578504656
0504.124-9	24"-600	8011578504670
0504.136-9	36"-900	8011578504694
0504.725-9	mm. 250-1-1/2"	8011578504809
0504.735-9	mm. 350-2"	8011578504823
0504.745-9	mm. 450-2"-1/2"	8011578504847
0504.760-9	mm. 600-3"	8011578504861
0504.790-9	mm. 900-4"	8011578504885
0504.950-9	mm. 300-4"	8011578504755
0504.960-9	mm. 900-6"	8011578504908
0504.990-9	Ø 90	8011578504922
0505.014-9	mm. 140	8011578505257
0505.018-9	mm. 180	8011578505301
0505.022-9	mm. 220	8011578505356
0505.032-9	mm. 320	8011578505400
0506.013-9	mm. 130	8011578506056
0506.017-9	mm. 170	8011578506100
0506.021-9	mm. 210	8011578506155
0506.031-9	mm. 310	8011578506209
0510.014-9	mm. 140	8011578510053
0510.018-9	mm. 180	8011578510107
0510.022-9	mm. 220	8011578510152
0510.032-9	mm. 320	8011578510206
0511.013-9	mm. 130	8011578511050
0511.017-9	mm. 170	8011578511104
0511.021-9	mm. 210	8011578511159
0511.031-9	mm. 310	8011578511203
0520.010-9	mm. 120	8011578520007

## Utensili in confezione self-service con codice a barre

## Bar code for hanged self-service packaging



0522.010-9	mm. 120	8011578522001
0524.010-9	mm. 120	8011578524005
0525.010-9	mm. 150	8011578525002
0526.010-9	mm. 115	8011578526009
0527.010-9	mm. 115	8011578527006
0528.010-9	mm. 120	8011578528003
0532.110-9	mm. 155	8011578532055
0532.210-9	mm. 155	8011578532109
0533.010-9		8011578533007
0534.010-9		8011578534004
0540.110-9	mm. 150	8011578540050
0540.210-9	mm. 150	8011578540104
0541.210-9	mm. 165	8011578541057
0552.010-9		8011578552008
0553.010-9		8011578553005
0558.010-9		8011578558000
0559.022-9	mm. 220	8011578559052
0559.024-9	mm. 240	8011578559106
0559.026-9	mm. 260	8011578559151
0559.030-9	mm. 300	8011578559205
0560.020-9	mm. 200	8011578560058
0560.025-9	mm. 250	8011578560102
0560.030-9	mm. 300	8011578560157
0561.010-9		8011578561000
0562.010-9		8011578562007
0563.010-9		8011578563004
0564.010-9		8011578564001
0565.010-9		8011578565008
0566.010-9		8011578566005
0567.010-9		8011578567019
0568.010-9		8011578568030
0569.010-9		8011578569051
0570.010-9		8011578570002
0572.010-9		8011578572006
0574.090-9		8011578574017
0574.100-9		8011578574000
0574.190-9		8011578574031
0574.200-9		8011578574024
0574.290-9		8011578574055
0574.300-9		8011578574048
0574.390-9		8011578574116
0574.400-9		8011578574062
0574.490-9		8011578574079
0574.500-9		8011578574086
0574.790-9		8011578574192
0574.800-9		8011578574109
0576.060-9	6	8011578576004
0576.080-9	8	8011578576059
0576.100-9	10	8011578576103
0576.120-9	12	8011578576158
0576.140-9	14	8011578576189
0576.160-9	16	8011578576196
0576.180-9	18	8011578576226
0576.200-9	20	8011578576233
0576.220-9	22	8011578576257
0576.250-9	25	8011578576288
0576.300-9	30	8011578576301



0580.060-9	6	8011578580100
0580.080-9	8	8011578580155
0580.100-9	10	8011578580209
0580.120-9	12	8011578580254
0580.140-9	14	8011578580308
0580.160-9	16	8011578580353
0580.180-9	18	8011578580407
0580.200-9	20	8011578580452
0580.220-9	22	8011578580506
0580.250-9	25	8011578580551
0580.300-9	30	8011578580605



0582.060-9	6	8011578582050
0582.080-9	8	8011578582104
0582.100-9	10	8011578582159
0582.120-9	12	8011578582203
0582.140-9	14	8011578582258
0582.160-9	16	8011578582302
0582.180-9	18	8011578582357
0582.200-9	20	8011578582401
0588.013-9	130	8011578588151
0588.014-9	140	8011578588205
0589.013-9	130	8011578589257
0589.014-9	140	8011578589301
0591.010-9	100	8011578591106
0591.011-9	110	8011578591113
0591.012-9	120	8011578591120
0592.010-9	100	8011578592103
0592.011-9	110	8011578592110
0592.012-9	120	8011578592127
0593.910-9		8011578593025
0594.010-9		8011578594008
0595.010-9		8011578595005
0596.010-9		8011578596002
0598.010-9		8011578598006
0598.910-9		8011578598020
0599.110-9	pz 12	8011578599010
0599.210-9	pz 12	8011578599058
0599.410-9	pz 10	8011578599041
0600.015-9	mm. 150	8011578600105
0600.020-9	mm. 200	8011578600204
0600.025-9	mm. 250	8011578600259
0600.030-9	mm. 300	8011578600266
0601.025-9		8011578601003
0601.030-9		8011578601034
0601.925-9	mm. 250	8011578601027
0601.930-9	mm. 300	8011578601041
0609.120-9	mm. 8 x 200	8011578609108
0609.220-9	mm. 10 x 200	8011578609153
0609.225-9	mm. 10 x 250	8011578609207
0609.230-9	mm. 10 x 300	8011578609252
0610.225-9	mm. 10 x 250	8011578610203
0612.013-9	mm. 8 x 125	8011578612009
0612.016-9	mm. 12 x 150	8011578612054
0614.013-9	mm. 8 x 125	8011578614058
0614.016-9	mm. 12 x 150	8011578614102
0615.100-9	mm. 1-10 x 125	8011578615055
0615.200-9	mm. 2-10 x 125	8011578615109
0615.300-9	mm. 3-10 x 125	8011578615154
0615.400-9	mm. 4-12 x 150	8011578615208
0615.500-9	mm. 5-12 x 150	8011578615253
0615.600-9	mm. 6-12 x 150	8011578615307
0616.012-9	mm. 10 x 120	8011578616052
0616.015-9	mm. 12 x 150	8011578616106
0616.910-9		8011578616120
0617.020-9	mm. 2	8011578617059
0617.030-9	mm. 3	8011578617073
0617.040-9	mm. 4	8011578617097
0617.050-9	mm. 5	8011578617127
0617.060-9	mm. 6	8011578617134
0617.080-9	mm. 8	8011578617158
0625.025-9	mm. 16 x 250	8011578625054
0625.030-9	mm. 16 x 300	8011578625108
0625.035-9	mm. 16 x 350	8011578625153
0625.040-9	mm. 16 x 400	8011578625207
0626.025-9	mm. 16 x 250	8011578626006
0626.030-9	mm. 16 x 300	8011578626051
0626.035-9	mm. 16 x 350	8011578626105
0626.040-9	mm. 16 x 400	8011578626150
0628.030-9	mm. 16 x 300	8011578628055
0628.035-9	mm. 16 x 350	8011578628109
0629.030-9	mm. 16 x 300	8011578629052
0629.035-9	mm. 16 x 350	8011578629106
0629.110-9		8011578629151



0630.030-9	mm. 16 x 300	8011578630003
0630.035-9	mm. 16 x 350	8011578630058
0631.030-9	mm. 16 x 300	8011578631000
0631.035-9	mm. 16 x 350	8011578631055
0633.050-9	50	8011578633059
0633.070-9	70	8011578633073
0638.010-9	gr. 100	8011578638009
0638.020-9	gr. 200	8011578638108
0638.030-9	gr. 300	8011578638054
0638.040-9	gr. 400	8011578638146
0638.050-9	gr. 500	8011578638153
0638.080-9	gr. 800	8011578638207
0640.020-9	gr. 200	8011578640101
0640.030-9	gr. 300	8011578640156
0640.040-9	gr. 400	8011578640200
0640.050-9	gr. 500	8011578640255
0671.010-9	mm. 400	8011578671006
0672.010-9	mm. 600	8011578672003
0680.010-9	mm. 145	8011578680008
0683.010-9	mm. 145	8011578683009
0686.110-9	mm. 145	8011578686055
0686.210-9	mm. 145	8011578686086
0689.010-9		8011578689001
0700.010-9	mm. 200	8011578700010
0702.010-9	mm. 450	8011578702106
0710.018-9	mm. 180	8011578710002
0710.020-9	mm. 200	8011578710026
0712.016-9	mm. 160	8011578712044
0712.020-9	mm. 200	8011578712068
0714.016-9	mm. 160	8011578714086
0714.020-9	mm. 200	8011578714109
0716.016-9	mm. 160	8011578716127
0722.010-9	mm. 160	8011578722142
0739.010-9		8011578739003
0740.010-9		8011578740009
0741.020-9	mm. 32-240	8011578741006
0741.040-9	mm. 52-400	8011578741020
0741.920-9		8011578741044
0741.940-9		8011578741068
0750.010-9		8011578750022
0751.010-9		8011578751005
0752.010-9		8011578752002
0756.010-9		8011578756000
0769.015-9	mm. 15	8011578769000
0769.022-9	mm. 22	8011578769024
0770.022-9	mm. 22	8011578770600
0772.032-9	mm. 32	8011578772635
0773.010-9	mm. 42	8011578773007



0774.032-9	mm. 32	8011578774653
0775.110-9	18 x 3 rame	8011578775674
0775.210-9	18 x 3 inox	8011578775698
0776.063-9	mm. 63	8011578776725
0776.110-9	18 x 6 rame	8011578776756
0776.210-9	18 x 6 inox	8011578776787
0776.310-9	22 x 6 plastica	8011578776817
0777.127-9	mm. 127	8011578777845
0777.210-9	42 x 11 plastica	8011578777876
0782.002-9	mm. 2"	8011578782900
0782.110-9	31 x 19 acciaio	8011578782931
0782.210-9	31 x 19 inox	8011578782962
0786.042-9		8011578786007
0790.042-9	mm. 42	8011578790998
0792.042-9	mm. 42	8011578792121
0792.142-9		8011578792145
0794.063-9	mm. 63	8011578794156
0794.163-9		8011578794170
0795.010-9		8011578795009



Utensili in confezione appendibile self-service con codice a barre

Bar code for hanged self-service packaging



0796.100-9		8011578796198
0796.300-9		8011578796181
0797.300-9		8011578797218
0798.240-9		8811578798246
0799.010-9		8011578799007
0815.010-9		8011578815035
0830.010-9		8011578830021
0832.010-9		8011578832001
0833.010-9	pz 10	8011578833008
0840.010-9	1/2" FEMMINA	8011578840006
0842.010-9	1/2"	8011578970390
0843.010-9	1/2"	8011578843021
1020.067-9	6-7	8011578020033
1020.089-9	8-9	8011578020071
1020.101-9	10-11	8011578020095
1020.123-9	12-13	8011578020125
1020.145-9	14-15	8011578020132
1020.167-9	16-17	8011578020156
1020.189-9	18-19	8011578020187
1020.202-9	20-22	8011578020200
1020.213-9	21-23	8011578020224
1020.246-9	24-26	8011578020248
1020.247-9	24-27	8011578020231
1020.258-9	25-28	8011578020262
1020.302-9	30-32	8011578020286
1020.326-9	32-36	8011578020309
1020.361-9	36-41	8011578020323
1020.416-9	41-46	8011578020347
1020.465-9	46-50	8011578020361
1025.067-9	6-7	8011578025021
1025.089-9	8-9	8011578025052
1025.101-9	10-11	8011578025076
1025.123-9	12-13	8011578025106
1025.145-9	14-15	8011578025120
1025.167-9	16-17	8011578025137
1025.189-9	18-19	8011578025151
1025.202-9	20-22	8011578025182
1025.213-9	21-23	8011578025205
1025.246-9	24-26	8011578025311
1025.247-9	24-27	8011578025250
1025.258-9	25-28	8011578025274
1025.302-9	30-32	8011578025298
1025.364-9	36-41	8011578025304



1030.055-9	5.5-5.5	8011578030001
1030.060-9	6-6	8011578030018
1030.070-9	7-7	8011578030032
1030.080-9	8-8	8011578030070
1030.090-9	9-9	8011578030094
1030.100-9	10-10	8011578030100
1030.110-9	11-11	8011578030131
1030.120-9	12-12	8011578030186
1030.130-9	13-13	8011578030209
1030.140-9	14-14	8011578030223
1030.150-9	15-15	8011578030254
1030.160-9	16-16	8011578030261
1030.170-9	17-17	8011578030285
1030.180-9	18-18	8011578030308
1030.190-9	19-19	8011578030315
1030.200-9	20-20	8011578030322
1030.210-9	21-21	8011578030353
1030.220-9	22-22	8011578030407
1030.230-9	23-23	8011578030421
1030.240-9	24-24	8011578030438
1030.250-9	25-25	8011578030445
1030.260-9	26-26	8011578030452
1030.270-9	27-27	8011578030506
1030.280-9	28-28	8011578030520
1030.290-9	29-29	8011578030681



1030.300-9	30-30	8011578030629
1030.320-9	32-32	8011578030605
1030.360-9	36-36	8011578030650
1030.410-9	41-41	8011578030674
1035.005-9	pollici 1/4"	8011578035006
1035.008-9	pollici 5/16"	8011578035020
1035.010-9	pollici 3/8"	8011578035044
1035.020-9	pollici 7/16"	8011578035068
1035.030-9	pollici 1/2"	8011578035082
1035.040-9	pollici 9/16"	8011578035105
1035.050-9	pollici 5/8"	8011578035129
1035.070-9	pollici 11/16"	8011578035143
1035.080-9	pollici 3/4"	8011578035167
1035.100-9	pollici 13/16"	8011578035181
1035.110-9	pollici 7/8"	8011578035204
1035.120-9	pollici 15/16"	8011578035228
1035.130-9	pollici 1"	8011578035242
1035.140-9	pollici 1.1/16"	8011578035266
1035.150-9	pollici 1.1/8"	8011578035280
1035.170-9	pollici 1.1/4"	8011578035303
1038.080-9	8-8	8011578038007
1038.100-9	10-10	8011578038021
1038.110-9	11-11	8011578038045
1038.120-9	12-12	8011578038069
1038.130-9	13-13	8011578038083
1038.140-9	14-14	8011578038106
1038.150-9	15-15	8011578038120
1038.170-9	17-17	8011578038144
1038.190-9	19-19	8011578038168
1040.080-9	8-8	8011578040000
1040.100-9	10-10	8011578040024
1040.110-9	11-11	8011578040048
1040.120-9	12-12	8011578040062
1040.130-9	13-13	8011578040086
1040.140-9	14-14	8011578040109
1040.150-9	15-15	8011578040123
1040.170-9	17-17	8011578040147
1040.190-9	19-19	8011578040161
1040.220-9	22-22	8011578040185
1040.240-9	24-24	8011578040208
1040.270-9	27-27	8011578040222
1040.300-9	30-30	8011578040246
1040.320-9	32-32	8011578040260
1040.460-9	46-46	8011578040284
1040.500-9	50-50	8011578040307
1040.550-9	55-55	8011578040321
1040.600-9	60-60	8011578040345
1040.700-9	70-70	8011578040369
1048.068-9	TX E6 x E8	8011578048006
1048.102-9	TX E10 x E12	8011578048020
1048.148-9	TX E14 x E18	8011578048044
1048.204-9	TX E20 x E24	8011578048068
1051.080-9	8 x 10	8011578051105
1051.091-9	9 x 11	8011578051129
1051.101-9	10 x 11	8011578051143
1051.113-9	11 x 13	8011578051167
1051.124-9	12 x 14	8011578051181
1051.179-9	17 x 19	8011578051204
1051.192-9	19 x 22	8011578051228
1051.224-9	22 x 24	8011578051242
1051.247-9	24 x 27	8011575051266
1051.302-9	30 x 32	8011578051280
1052.212-9	21-22	8011578052010
1053.212-9		8011578053000
1055.080-9	8	8011578055103
1055.090-9	9	8011578055127
1055.100-9	10	8011578055141
1055.110-9	11	8011578055165
1055.120-9	12	8011578055189
1055.130-9	13	8011578055202
1055.140-9	14	8011578055226
1055.150-9	15	8011578055240



1055.160-9	16	8011578055264
1055.170-9	17	8011578055288
1055.180-9	18	8011578055301
1055.190-9	19	8011578055325
1060.080-9	8	8011578060053
1060.090-9	9	8011578060077
1060.100-9	10	8011578060091
1060.110-9	11	8011578060114
1060.120-9	12	8011578060138
1060.130-9	13	8011578060152
1060.140-9	14	8011578060176
1060.150-9	15	8011578060190
1060.160-9	16	8011578060213
1060.170-9	17	8011578060237
1060.180-9	18	8011578060251
1060.190-9	19	8011578060275
1060.220-9	22	8011578060299
1060.240-9	24	8011578060312
1065.080-9	mm. 8	8011578068004
1065.100-9	mm. 10	8011578068028
1065.130-9	mm. 13	8011578068042
1065.170-9	mm. 17	8011578068066
1065.190-9	mm. 19	8011578068080
1067.080-9	mm. 8	8011578067021
1067.100-9	mm. 10	8011578067045
1067.130-9	mm. 13	8011578067069
1067.170-9	mm. 17	8011578067083
1067.190-9	mm. 19	8011578067106
1069.104-9	MM 10-1/4"	8011578069001
1069.138-9	MM 13-3/8"	8011578069025
1069.192-9	MM 19-1/2"	8011578069049
1069.914-9	MM 10-1/4" BIT	8011578069063
1070.015-9	150	8011578070151
1070.020-9	200	8011578070205
1070.025-9	250	8011578070250
1070.030-9	300	8011578070304
1070.037-9	375	8011578070328
1070.045-9	450	8011578070342
1074.024-9	mm. 24	8011578074005
1074.027-9	mm. 27	8011578074029
1074.030-9	mm. 30	8011578074043
1074.032-9	mm. 32	8011578074067
1074.036-9	mm. 36	8011578074081
1074.041-9	mm. 41	8011578074104
1074.046-9	mm. 46	8011578074128
1074.050-9	mm. 50	8011578074142
1074.055-9	mm. 55	8011578074166
1074.060-9	mm. 60	8011578074180
1074.065-9	mm. 65	8011578074203
1074.070-9	mm. 70	8011578074227
1074.946-9	mm. 460	8011578074241
1074.961-9	mm. 610	8011578074265
1074.976-9	mm. 760	8011578074289
1074.986-9	mm. 860	8011578074302
1075.024-9	mm. 24	8011578075262
1075.027-9	mm. 27	8011578075286
1075.030-9	mm. 30	8011578075309
1075.032-9	mm. 32	8011578075002
1075.036-9	mm. 36	8011578075026
1075.041-9	mm. 41	8011578075040
1075.046-9	mm. 46	8011578075064
1075.050-9	mm. 50	8011578075088
1075.055-9	mm. 55	8011578075101
1075.060-9	mm. 60	8011578075125
1075.065-9	mm. 65	8011578075149
1075.070-9	mm. 70	8011578075163
1075.075-9	mm. 75	8011578075177
1075.080-9	mm. 80	8011578075181
1075.085-9	mm. 85	8011578075195
1075.090-9	mm. 90	8011578075209
1075.095-9	mm. 95	8011578075223
1075.100-9	mm. 100	8011578075237

## Utensili in confezione self-service con codice a barre

## Bar code for hanged self-service packaging



1076.024-9	mm. 24	8011578076009
1076.027-9	mm. 27	8011578076023
1076.030-9	mm. 30	8011578076047
1076.032-9	mm. 32	8011578076061
1076.036-9	mm. 36	8011578076085
1076.041-9	mm. 41	8011578076108
1076.046-9	mm. 46	8011578076122
1076.050-9	mm. 50	8011578076146
1076.055-9	mm. 55	8011578076160
1076.060-9	mm. 60	8011578076184
1076.065-9	mm. 65	8011578076207
1076.070-9	mm. 70	8011578076221
1076.075-9	mm. 75	8011578076238
1076.080-9	mm. 80	8011578076245
1076.085-9	mm. 85	8011578076252
1076.090-9	mm. 90	8011578076269
1076.095-9	mm. 95	8011578076283
1076.100-9	mm. 100	8011578076306
1077.025-9		8011578077006
1078.067-9	6 x 7	8011578078003
1078.078-9	7 x 8	8011578078027
1078.083-9	8 x 9	8011578078041
1078.085-9	8 x 10	8011578078065
1078.101-9	10 x 11	8011578078089
1078.103-9	10 x 13	8011578078102
1078.123-9	12 x 13	8011578078126
1078.137-9	13 x 17	8011578078140
1078.175-9	17 x 19	8011578078164
1078.177-9	17 x 22	8011578078188
1078.192-9	19 x 22	8011578078201
1078.194-9	19 x 24	8011578078225
1078.202-9	20 x 22	8011578078249
1078.224-9	22 x 24	8011578078263
1078.242-9	24 x 27	8011578078287
1078.243-9	24 x 30	8011578078324
1078.273-9	27 x 30	8011578078348
1078.302-9	30 x 32	8011578078300
1078.363-9	36 x 41	8011578078362
1079.006-9	mm. 6	8011578079000
1079.007-9	mm. 7	8011578079024
1079.008-9	mm. 8	8011578079048
1079.009-9	mm. 9	8011578079062
1079.010-9	mm. 10	8011578079086
1079.012-9	mm. 12	8011578079420
1079.013-9	mm. 13	8011578079109
1079.015-9	mm. 15	8011578079444
1079.017-9	mm. 17	8011578079123
1079.019-9	mm. 19	8011578079147
1079.022-9	mm. 22	8011578079161
1079.024-9	mm. 24	8011578079185
1079.027-9	mm. 27	8011578079208
1079.030-9	mm. 30	8011578079222
1079.032-9	mm. 32	8011578079246
1079.034-9	mm. 34	8011578079468
1079.036-9	mm. 36	8011578079260
1079.038-9	mm. 38	8011578079482
1079.041-9	mm. 41	8011578079284
1079.042-9	mm. 42	8011578079505
1079.046-9	mm. 46	8011578079307
1079.050-9	mm. 50	8011578079321
1079.055-9	mm. 55	8011578079345
1079.060-9	mm. 60	8011578079369
1079.065-9	mm. 65	8011578079383
1079.070-9	mm. 70	8011578079406
1079.075-9	mm. 75	8011578079529
1079.080-9	mm. 80	8011578079543
1079.085-9	mm. 85	8011578079567
1079.090-9	mm. 90	8011578079581
1079.095-9	mm. 95	8011578079604
1079.100-9	mm. 100	8011578079642
1079.105-9	mm. 105	8011578079659
1080.067-9	mm. 6-7	8011578080068



1080.089-9	mm. 8-9	8011578080082
1080.101-9	mm. 10-11	8011578080105
1080.123-9	mm. 12-13	8011578080129
1080.145-9	mm. 14-15	8011578080143
1080.167-9	mm. 16-17	8011578080167
1080.189-9	mm. 18-19	8011578080181
1080.202-9	mm. 20-22	8011578080204
1080.246-9	mm. 24-26	8011578080242
1080.258-9	mm. 25-28	8011578080259
1080.302-9	mm. 30-32	8011578080303
1080.555-9	mm. 55-55	8011578080501
1090.060-9	mm. 6-6	8011578090067
1090.070-9	mm. 7-7	8011578090074
1090.080-9	mm. 8-8	8011578090081
1090.090-9	mm. 9-9	8011578090098
1090.100-9	mm. 10-10	8011578090104
1090.110-9	mm. 11-11	8011578090111
1090.120-9	mm. 12-12	8011578090128
1090.130-9	mm. 13-13	8011578090135
1090.140-9	mm. 14-14	8011578090142
1090.150-9	mm. 15-15	8011578090159
1090.160-9	mm. 16-16	8011578090166
1090.170-9	mm. 17-17	8011578090173
1090.190-9	mm. 19-19	8011578090197
1090.200-9	mm. 20-20	8011578090203
1090.220-9	mm. 22-22	8011578090227
1092.067-9	6 x 7	8011578092054
1092.089-9	8 x 9	8011578092078
1092.101-9	10 x 11	8011578092092
1092.123-9	12 x 13	8011578092115
1092.145-9	14 x 15	8011578092139
1092.167-9	16 x 17	8011578092153
1092.189-9	18 x 19	8011578092177
1092.202-9	20 x 22	8011578092191
1092.213-9	21 x 23	8011578092214
1092.246-9	24 x 26	8011578092238
1092.258-9	25 x 28	8011578092252
1092.279-9	27 x 29	8011578092276
1092.302-9	30 x 32	8011578092290
1096.067-9	6 x 7	8011578096052
1096.089-9	8 x 9	8011578096076
1096.101-9	10 x 11	8011578096090
1096.123-9	12 x 13	8011578096113
1096.145-9	14 x 15	8011578096137
1096.167-9	16 x 17	8011578096151
1096.189-9	18 x 19	8011578096175
1096.202-9	20 x 22	8011578096199
1097.910-9	5-8-10	8011578097073
1097.912-9	12 x 250	8011578097127
1097.914-9	14 x 320	8011578097080
1097.919-9	19 x 400	8011578097103



1098.060-9	6	8011578098056
1098.070-9	7	8011578098070
1098.080-9	8	8011578098094
1098.090-9	9	8011578098117
1098.100-9	10	8011578098131
1098.110-9	11	8011578098155
1098.120-9	12	8011578098179
1098.130-9	13	8011578098193
1098.140-9	14	8011578098216
1098.150-9	15	8011578098230
1098.160-9	16	8011578098254
1098.170-9	17	8011578098278
1098.180-9	18	8011578098292
1098.190-9	19	8011578098315
1098.200-9	20	8011578098339
1098.210-9	21	8011578098353
1098.220-9	22	8011578098377



1098.230-9	23	8011578098391
1098.240-9	24	8011578098414
1098.270-9	27	8011578098438
1098.300-9	30	8011578098452
1098.320-9	32	8011578098476
1150.060-9	mm. 6	8011578001032
1150.070-9	mm. 7	8011578001063
1150.080-9	mm. 8	8011578001094
1150.090-9	mm. 9	8011578001124
1150.100-9	mm. 10	8011578001155
1150.110-9	mm. 11	8011578001186
1150.120-9	mm. 12	8011578001216
1150.130-9	mm. 13	8011578001247
1150.140-9	mm. 14	8011578001278
1150.150-9	mm. 15	8011578001308
1150.160-9	mm. 16	8011578001339
1150.170-9	mm. 17	8011578001360
1150.180-9	mm. 18	8011578001391
1150.190-9	mm. 19	8011578001421
1150.200-9	mm. 20	8011578001452
1150.210-9	mm. 21	8011578001483
1150.220-9	mm. 22	8011578001513
1150.240-9	mm. 24	8011578001575
1152.030-9	mm. 3	8011578001506
1152.040-9	mm. 4	8011578001520
1152.050-9	mm. 5	8011578001544
1152.060-9	mm. 6	8011578001568
1152.080-9	mm. 8	8011578001537
1155.005-9	1/4"	8011578001612
1155.010-9	3/8"	8011578001599
1155.020-9	1/2"	8011578001988
1158.140-9	14	8011578005009
1158.160-9	16	8011578001551
1158.200-9	20	8011578001605
1170.016-9	16	8011578117009
1170.021-9	21	8011578117023
1325.070-9	7	8011578001681
1325.080-9	8	8011578001728
1325.100-9	10	8011578001780
1325.120-9	12	8011578001841
1325.130-9	13	8011578001872
1328.060-9	mm. 6	8011578004064
1328.070-9	mm. 7	8011578004071
1328.080-9	mm. 8	8011578004088
1328.090-9	mm. 9	8011578004095
1328.100-9	mm. 10	8011578004101
1328.110-9	mm. 11	8011578004118
1328.120-9	mm. 12	8011578004125
1328.130-9	mm. 13	8011578004132
1328.140-9	mm. 14	8011578004149
1328.150-9	mm. 15	8011578004156
1328.160-9	mm. 16	8011578004163
1328.170-9	mm. 17	8011578004170
1328.180-9	mm. 18	8011578004187
1328.190-9	mm. 19	8011578004194
1328.220-9	mm. 22	8011578004224
1328.240-9	mm. 24	8011578004248
1334.270-9	27 x 30	8011578901646
1334.272-9	27 x 32	8011578901660
1334.303-9	30 x 33	8011578901684
1334.910-9	19 x 400	8011578901707
1336.179-9	17x19x22x1/2"	8011578901608
1336.247-9	24x27x32x3/4"	8011578901622
1338.050-9	mm. 500	8011578133801
1339.010-9	mm. 20	8011578133900
1340.010-9	135	8011578340001
1340.020-9	220	8011578340018
1341.010-9	110	8011578341015
1341.020-9	160	8011578341022
1345.250-9	250 x 120	8011578345600
1345.300-9	300 x 140	8011578345624
1345.400-9	400 x 120	8011578345648

Utensili in confezione appendibile self-service con codice a barre

Bar code for hanged self-service packaging



1345.500-9	500 x 120	8011578345662
1345.600-9	600 x 120	8011578345686
1347.250-9	250 x 120	8011578347024
1347.300-9	300 x 140	8011578347048
1347.400-9	400 x 120	8011578347062
1347.500-9	500 x 120	8011578347086
1350.035-9	15-35	8011578350000
1350.050-9	35-50	8011578350017
1350.080-9	50-80	8011578350024
1350.120-9	80-120	8011578350048
1350.180-9	120-180	8011578350062
1352.028-9	25-28	8011578352004
1352.032-9	30-32	8011578352028
1352.036-9	34-36	8011578352066
1352.042-9	40-42	8011578352080
1352.050-9	45-50	8011578352103
1352.055-9	52-55	8011578352127
1352.062-9	58-62	8011578352141
1352.075-9	68-75	8011578352165
1352.090-9	80-90	8011578352189
1352.095-9	92-95	8011578352158
1352.100-9	98-100	8011578352202
1352.115-9	110-115	8011578352226
1352.130-9	120-130	8011578352240
1352.145-9	135-145	8011578352264
1352.165-9	155-165	8011578352288
1352.195-9	180-195	8011578352301
1360.011-9	110	8011578360368
1360.015-9	155	8011578360382
1360.211-9	110	8011578360405
1360.215-9	155	8011578360429
1362.015-9	1/2" 115	8011578362003
1363.015-9	115	8011578363000
1364.010-9	60-140	8011578364007
1370.101-9		8011578370169
1383.010-9		8011578383343
1385.010-9		8011578385033
1386.010-9		8011578386061
1388.038-9	mm. 38	8011578388065
1388.055-9	mm. 55	8011578388089
1400.040-9	mm. 4	8011578002039
1400.045-9	mm. 4.5	8011578002046
1400.050-9	mm. 5	8011578002060
1400.055-9	mm. 5.5	8011578002084
1400.060-9	mm. 6	8011578002091
1400.070-9	mm. 7	8011578002121
1400.080-9	mm. 8	8011578002145
1400.090-9	mm. 9	8011578002169
1400.100-9	mm. 10	8011578002183
1400.110-9	mm. 11	8011578002206
1400.120-9	mm. 12	8011578002213
1400.130-9	mm. 13	8011578002244
1402.040-9	LUNGA mm. 4	8011578140205
1402.045-9	LUNGA mm. 4,5	8011578140229
1402.050-9	LUNGA mm. 5	8011578140250
1402.055-9	LUNGA mm. 5,5	8011578140267
1402.060-9	LUNGA mm. 6	8011578140281
1402.070-9	LUNGA mm. 7	8011578140304
1402.080-9	LUNGA mm. 8	8011578140328
1402.090-9	LUNGA mm. 9	8011578140342
1402.100-9	LUNGA mm. 10	8011578140366
1402.110-9	LUNGA mm. 11	8011578140380
1402.120-9	LUNGA mm. 12	8011578140403
1402.130-9	LUNGA mm. 13	8011578140427
1402.140-9	LUNGA mm. 14	8011578140243
1404.040-9	TX E 4 FEM	8011578140441
1404.050-9	TX E 5 FEM	8011578140458
1404.060-9	TX E 6 FEM	8011578140465
1404.070-9	TX E 7 FEM	8011578140472
1404.080-9	TX E 8 FEM	8011578140489
1404.100-9	TX E 10 FEM	8011578140410
1405.010-9	1/4"	8011578002282



1405.910-9	1/4"	8011578140502
1406.010-9	1/4"	8011578002459
1407.010-9	1/4"-1/4"	8011578140700
1408.075-9	mm. 75	8011578002305
1408.150-9	mm. 150	8011578002329
1410.010-9	1/4"	8011578002343
1412.010-9	1/4"	8011578002367
1414.010-9	1/4"	8011578002381
1420.010-9		8011578002404
1425.010-9	1/4" F x 3/8" M	8011578002428
1430.300-9	mm. 3	8011578900014
1430.400-9	mm. 4	8011578900038
1430.500-9	mm. 5	8011578900052
1430.600-9	mm. 6	8011578900076
1432.100-9	PH 1	8011578900090
1432.200-9	PH 2	8011578900113
1432.300-9	PH 3	8011578900137
1434.100-9	PZ 1	8011578900151
1434.200-9	PZ 2	8011578900175
1434.300-9	PZ 3	8011578900199
1436.030-9	3	8011578900212
1436.040-9	4	8011578900236
1436.050-9	5	8011578900250
1436.060-9	6	8011578900274
1436.080-9	8	8011578900298
1438.080-9	TX 8	8011578900311
1438.100-9	TX 10	8011578900335
1438.150-9	TX 15	8011578900359
1438.200-9	TX 20	8011578900373
1438.250-9	TX 25	8011578900397
1438.270-9	TX 27	8011578900410
1438.300-9	TX 30	8011578900434
1438.400-9	TX 40	8011578900458
1450.060-9	mm. 6	8011578002466
1450.070-9	mm. 7	8011578002480
1450.080-9	mm. 8	8011578002503
1450.090-9	mm. 9	8011578002527
1450.100-9	mm. 10	8011578002541
1450.110-9	mm. 11	8011578002565
1450.120-9	mm. 12	8011578002589
1450.130-9	mm. 13	8011578002602
1450.140-9	mm. 14	8011578002626
1450.150-9	mm. 15	8011578002640
1450.160-9	mm. 16	8011578002664
1450.170-9	mm. 17	8011578002688
1450.180-9	mm. 18	8011578002701
1450.190-9	mm. 19	8011578002725
1450.200-9	mm. 20	8011578002749
1450.210-9	mm. 21	8011578002763
1450.220-9	mm. 22	8011578002787
1455.010-9	3/8"	8011578002800
1458.075-9	mm. 75	8011578002824
1458.150-9	mm. 150	8011578002848
1460.010-9	3/8"	8011578002862
1462.010-9	3/8"	8011578002886
1470.010-9	3/8"-1/4"	8011578002909
1475.010-9	3/8" F x 1/4" M	8011578002923
1475.020-9	3/8" F x 1/2" M	8011578002947
1477.160-9	mm. 16	8011578002961
1477.210-9	mm. 21	8011578002985



1500.080-9	mm. 8	8011578003678
1500.090-9	mm. 9	8011578003685
1500.100-9	mm. 10	8011578003067
1500.110-9	mm. 11	8011578003081
1500.120-9	mm. 12	8011578003104
1500.130-9	mm. 13	8011578003128
1500.140-9	mm. 14	8011578003142
1500.150-9	mm. 15	8011578003166



1500.160-9	mm. 16	8011578003180
1500.170-9	mm. 17	8011578003203
1500.180-9	mm. 18	8011578003227
1500.190-9	mm. 19	8011578003241
1500.200-9	mm. 20	8011578003265
1500.210-9	mm. 21	8011578003289
1500.220-9	mm. 22	8011578003302
1500.230-9	mm. 23	8011578003326
1500.240-9	mm. 24	8011578003340
1500.250-9	mm. 25	8011578003364
1500.260-9	mm. 26	8011578003388
1500.270-9	mm. 27	8011578003401
1500.280-9	mm. 28	8011578003425
1500.300-9	mm. 30	8011578003449
1500.320-9	mm. 32	8011578003463
1501.080-9	mm. 8	8011578150143
1501.090-9	mm. 9	8011578150167
1501.100-9	mm. 10	8011578150181
1501.110-9	mm. 11	8011578150198
1501.120-9	mm. 12	8011578150136
1501.130-9	mm. 13	8011578150129
1501.140-9	mm. 14	8011578845025
1501.150-9	mm. 15	8011578150174
1501.160-9	mm. 16	8011578501020
1501.170-9	mm. 17	8011578970413
1501.180-9	mm. 18	8011578150112
1501.190-9	mm. 19	8011578501044
1501.210-9	mm. 21	8011578501068
1501.220-9	mm. 22	8011578501082
1501.240-9	mm. 24	8011578501105
1501.270-9	mm. 27	8011578501129
1501.300-9	mm. 30	8011578501143
1501.320-9	mm. 32	8011578501167
1502.100-9	mm. 10	8011578150211
1502.110-9	mm. 11	8011578150235
1502.120-9	mm. 12	8011578150242
1502.130-9	mm. 13	8011578150259
1502.140-9	mm. 14	8011578150266
1502.150-9	mm. 15	8011578150280
1502.160-9	mm. 16	8011578150297
1502.170-9	mm. 17	8011578150303
1502.180-9	mm. 18	8011578150310
1502.190-9	mm. 19	8011578150341
1502.210-9	mm. 21	8011578150334
1502.220-9	mm. 22	8011578150358
1502.240-9	mm. 24	8011578150372
1502.270-9	mm. 27	8011578150426
1502.300-9	mm. 30	8011578150440
1502.320-9	mm. 32	8011578150464
1504.010-9	3/8"	8011578900007
1504.020-9	7/16"	8011578504007
1504.030-9	1/2"	8011578504021
1504.040-9	9/16"	8011578504045
1504.050-9	5/8"	8011578150488
1504.060-9	19/32"	8011578150419
1504.070-9	11/16"	8011578150433
1504.080-9	3/4"	8011578900748
1504.090-9	25/32"	8011578150471
1504.100-9	13/16"	8011578150495
1504.110-9	7/8"	8011578504069
1504.120-9	15/16"	8011578504083
1504.130-9	1"	8011578504106
1504.140-9	1.1/16"	8011578504120
1504.150-9	1.1/8"	8011578504144
1504.160-9	1.3/16"	8011578504168
1504.170-9	1.1/4"	8011578504182
1505.010-9	1/2"	8011578003487
1505.910-9	1/2"	8011578003692
1506.010-9	1/2"	8011578003494
1507.010-9	1/2"	8011578003470
1508.125-9	mm. 125	8011578003500
1508.250-9	mm. 250	8011578003524



## Utensili in confezione self-service con codice a barre

## Bar code for hanged self-service packaging



1509.125-9	mm. 125	8011578003548
1509.250-9	mm. 250	8011578003562
1510.010-9	1/2"	8011578003586
1512.010-9	1/2"	8011578003609
1520.010-9	1/2"-1/4"	8011578003616
1525.010-9	1/2" F x 3/8" M	8011578003623
1525.015-9	1/2" F x 3/4" M	8011578003630
1527.160-9	mm. 16	8011578003647
1527.210-9	mm. 21	8011578003661
1530.040-9	4	8011578900472
1530.050-9	5	8011578900496
1530.060-9	6	8011578900519
1530.080-9	8	8011578900533
1530.100-9	10	8011578900557
1530.120-9	12	8011578900571
1530.140-9	14	8011578900595
1530.170-9	17	8011578900618
1530.190-9	19	8011578900632
1531.050-9	mm. 5	8011578153113
1531.060-9	mm. 6	8011578153120
1531.080-9	mm. 8	8011578153137
1531.100-9	mm. 10	8011578153144
1531.205-9	mm. 5 X 140	8011578153151
1531.206-9	mm. 6 X 140	8011578153168
1531.208-9	mm. 8 X 140	8011578153182
1531.210-9	mm. 10 X 140	8011578153199
1532.050-9	mm. 5 X 90	8011578153212
1532.060-9	mm. 6 X 90	8011578153229
1532.080-9	mm. 8 X 90	8011578153243
1534.200-9	TX 20	8011578900656
1534.250-9	TX 25	8011578900670
1534.270-9	TX 27	8011578900694
1534.300-9	TX 30	8011578900717
1534.400-9	TX 40	8011578900731
1534.450-9	TX 45	8011578900755
1534.500-9	TX 50	8011578900779
1534.840-9	40 x 90	8011578153403
1534.845-9	45 x 90	8011578153427
1534.850-9	50 x 90	8011578153441
1534.855-9	55 x 90	8011578153465
1534.860-9	60 x 90	8011578153489
1534.870-9	70 x 90	8011578153410
1534.940-9	40 x 140	8011578153434
1534.945-9	45 x 140	8011578153458
1534.950-9	50 x 140	8011578153472
1534.955-9	55 x 140	8011578153496
1535.100-9	TX E 10 FEM	8011578153502
1535.120-9	TX E 12 FEM	8011578153526
1535.140-9	TX E 14 FEM	8011578153540
1535.160-9	TX E 16 FEM	8011578153564
1535.180-9	TX E 18 FEM	8011578153588
1535.200-9	TX E 20 FEM	8011578153595
1535.240-9	TX E 24 FEM	8011578153571
1537.040-9	XZN M 4 X 55	8011578153700
1537.050-9	XZN M 5 X 55	8011578153717
1537.060-9	XZN M 6 X 55	8011578153731
1537.080-9	XZN M 8 X 55	8011578153755
1537.100-9	XZN M 10 X 55	8011578153779
1537.120-9	XZN M 12 X 55	8011578153793
1538.060-9	RIBE 6 X 55	8011578153809
1538.070-9	RIBE 7 X 55	8011578153823
1538.080-9	RIBE 8 X 55	8011578153847
1538.100-9	RIBE 10 X 55	8011578153861
1538.120-9	RIBE 12 X 55	8011578153885
1600.220-9	mm. 22	8011578901721
1600.230-9	mm. 23	8011578901745
1600.240-9	mm. 24	8011578901769
1600.260-9	mm. 26	8011578901783
1600.270-9	mm. 27	8011578901806
1600.280-9	mm. 28	8011578901820
1600.300-9	mm. 30	8011578901844
1600.320-9	mm. 32	8011578901868



1600.330-9	mm. 33	8011578901882
1600.340-9	mm. 34	8011578901805
1600.360-9	mm. 36	8011578901929
1600.380-9	mm. 38	8011578901943
1600.410-9	mm. 41	8011578901967
1600.460-9	mm. 46	8011578901981
1600.500-9	mm. 50	8011578902001
1600.550-9	mm. 55	8011578902018
1600.600-9	mm. 60	8011578902032
1605.010-9	3/4"	8011578902063
1608.100-9	mm. 100	8011578902094
1608.200-9	mm. 200	8011578902117
1608.400-9	mm. 400	8011578902131
1610.010-9	3/4"	8011578902155
1612.010-9	3/4"	8011578902179
1625.010-9	3/4"-1/2"	8011578902193
1642.360-9	mm. 36	8011578642006
1642.410-9	mm. 41	8011578642020
1642.460-9	mm. 46	8011578642044
1642.500-9	mm. 50	8011578642068
1642.550-9	mm. 55	8011578642082
1642.600-9	mm. 60	8011578642105
1642.650-9	mm. 65	8011578642129
1642.700-9	mm. 70	8011578642143
1642.750-9	mm. 75	8011578642167
1642.800-9	mm. 80	8011578642181
1645.010-9	1"	8011578645007
1646.010-9	1"	8011578646004
1647.200-9	mm. 200	8011578647001
1647.400-9	mm. 400	8011578647025
1648.010-9	1-3/4"	8011578648008
1650.080-9	mm. 8	8011578650018
1650.100-9	mm. 10	8011578650001
1650.110-9	mm. 11	8011578650025
1650.120-9	mm. 12	8011578650049
1650.130-9	mm. 13	8011578650063
1650.140-9	mm. 14	8011578650087
1650.150-9	mm. 15	8011578650100
1650.160-9	mm. 16	8011578650124
1650.170-9	mm. 17	8011578650148
1650.180-9	mm. 18	8011578650162
1650.190-9	mm. 19	8011578650186
1650.210-9	mm. 21	8011578650209
1650.220-9	mm. 22	8011578650223
1650.240-9	mm. 24	8011578650247
1650.270-9	mm. 27	8011578650261
1650.300-9	mm. 30	8011578650285
1650.320-9	mm. 32	8011578650308
1652.100-9	mm. 10	8011578652005
1652.130-9	mm. 13	8011578652029
1652.140-9	mm. 14	8011578652043
1652.150-9	mm. 15	8011578652166
1652.170-9	mm. 17	8011578652067
1652.190-9	mm. 19	8011578652081
1652.210-9	mm. 21	8011578652159
1652.220-9	mm. 22	8011578652104
1652.240-9	mm. 24	8011578652128
1652.270-9	mm. 27	8011578652142
1653.012-9	1/2"	8011578653002
1654.010-9	1/2"	8011578654009
1664.170-9	mm. 17	8011578664008
1664.190-9	mm. 19	8011578664022
1664.210-9	mm. 21	8011578664046
1664.220-9	mm. 22	8011578664060
1664.230-9	mm. 23	8011578664084
1664.240-9	mm. 24	8011578664091
1664.260-9	mm. 26	8011578664121
1664.270-9	mm. 27	8011578664107
1664.300-9	mm. 30	8011578664145
1664.320-9	mm. 32	8011578664169
1664.330-9	mm. 33	8011578664183
1664.360-9	mm. 36	8011578664206



1664.380-9	mm. 38	8011578664220
1664.410-9	mm. 41	8011578664244
1664.460-9	mm. 46	8011578664268
1665.170-9	mm. 17	8011578166502
1665.190-9	mm. 19	8011578166519
1665.220-9	mm. 22	8011578166526
1665.240-9	mm. 24	8011578166533
1665.270-9	mm. 27	8011578166540
1665.300-9	mm. 30	8011578166557
1665.320-9	mm. 32	8011578166564
1665.330-9	mm. 33	8011578166571
1665.360-9	mm. 36	8011578166588
1665.410-9	mm. 41	8011578166595
1665.460-9	mm. 46	8011578665005
1666.010-9	3/4"	8011578166601
1667.010-9	3/4"	8011578166700
1668.010-9	3/4"-1/2"	8011578166809
1669.010-9	3/4"	8011578166908
1669.050-9	3/4"	8011578166922
1670.360-9	mm. 36	8011578167004
1670.410-9	mm. 41	8011578167028
1670.460-9	mm. 46	8011578167042
1670.500-9	mm. 50	8011578167066
1670.550-9	mm. 55	8011578167080
1670.600-9	mm. 60	8011578167103
1670.650-9	mm. 65	8011578167127
1671.010-9	1"	8011578167110
1673.010-9	1-3/4"	8011578167301
1674.010-9	1"	8011578167400
1674.050-9	1"	8011578167424
1700.110-9	20-110 Nm-1/2"	8011578700003
1700.210-9	42-210 Nm-1/2"	8011578700027
1700.350-9	70-350 Nm-1/2"	8011578700041
1702.025-9	5-25 Nm-1/4"	8011578702069
1702.050-9	10-50 Nm-3/8"	8011578702083
1702.100-9	10-100 Nm-1/2"	8011578702007
1702.200-9	20-200 Nm-1/2"	8011578702021
1702.300-9	60-300 Nm-1/2"	8011578702045
1820.030-9	3	8011578820039
1820.050-9	5	8011578820053
1830.010-9	mm. 180	8011578830007
1835.010-9	145	8011578835002
1844.010-9	3	8011578843007
1845.010-9	mm. 18	8011578845001



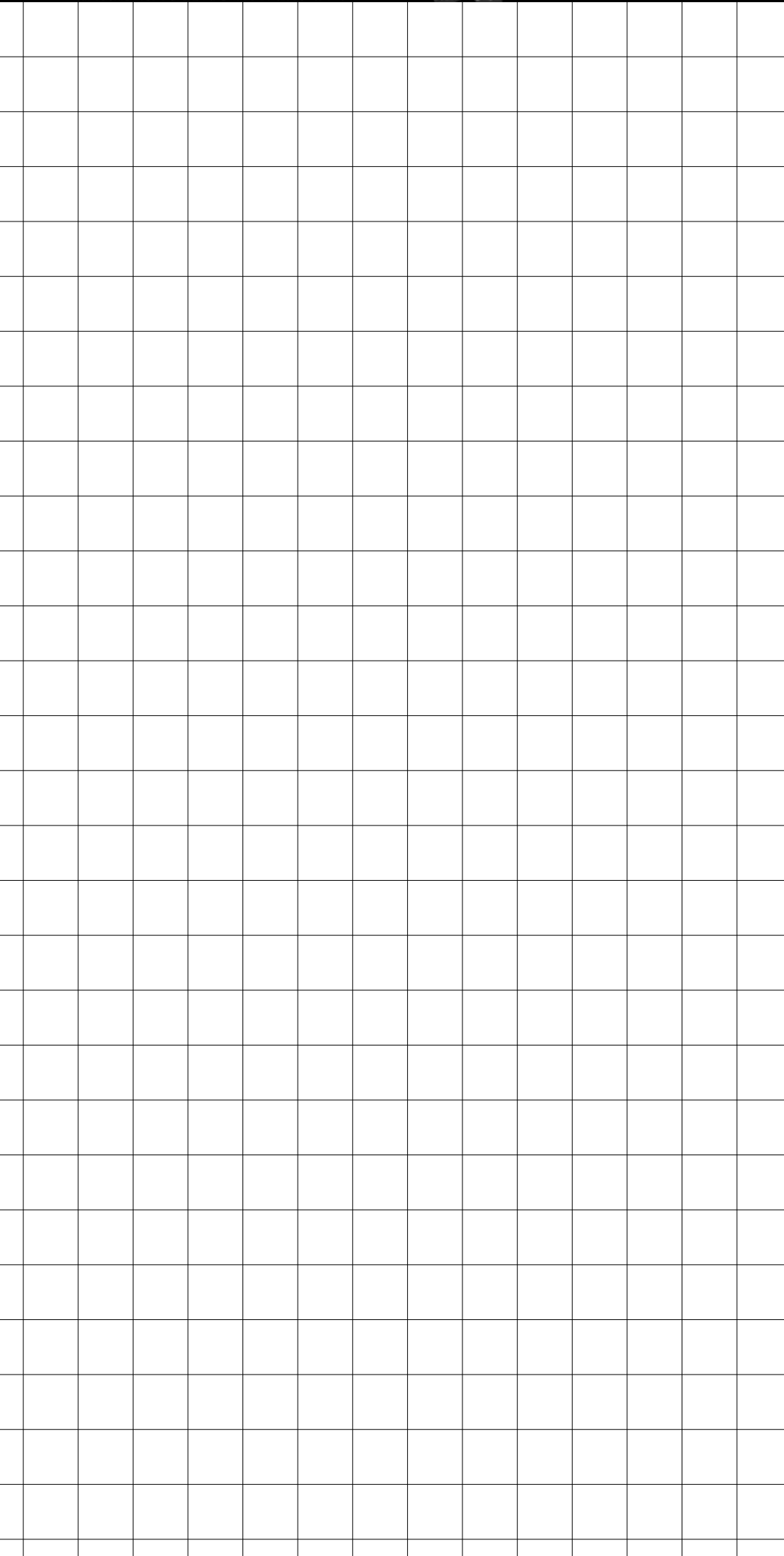



Rivenditore - Dealer:

